

5. Carefully remove final drive (1). The weight of final drive (1) and the sprocket is approximately 312 kg (688 lb).
6. Remove Tooling (C) from the frame.

Disassembly Procedure

Table 4

Required Tools			
Tool	Part Number	Part Description	Qty
A	1P-2420	Transmission Repair Stand	1
B	439-3938	Link Bracket	2
C	1P-1863	Retaining Ring Pliers	1
D	439-3940	Bracket As	3
E	4C-8359	Eyebolt	2
F	439-3939	Link Bracket As	2
G	439-3941	Link Bracket As	2

Start By:

- a. Remove the final drive.

Note: Cleanliness is an important factor. Before the disassembly procedure, the exterior of the component should be thoroughly cleaned. This will prevent dirt from entering the internal mechanism.

1. Put an alignment mark across the sections of the final drive for assembly purposes. The parts must be reinstalled to the original locations.



Illustration 7

g00892878

2. Use Tooling (G) and a suitable lifting device to position the final drive assembly onto Tooling (A). The weight of the final drive assembly is approximately 550 kg (1200 lb).
3. Remove bolts (1).

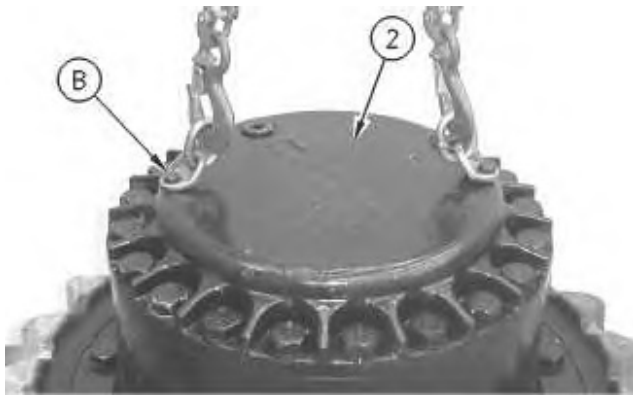

Illustration 8

g00892883

4. Use Tooling (B) and a suitable lifting device to remove cover (2). The weight of cover (2) is approximately 32 kg (70 lb).

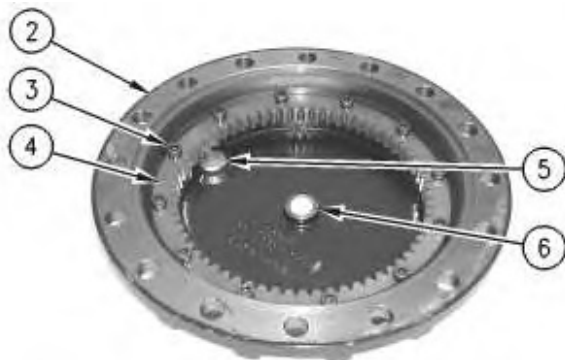

Illustration 9

g00892888

5. Remove bolts (3) and gear (4). Check plate (6). Replace plate (6) if plate (6) is worn. Remove plugs (5) from cover (2).



Illustration 10

g00892906

6. Remove O-ring seals (7) from plugs (5).
-



Illustration 11

g00892930

7. Remove gear (8) and spacer (9).



Illustration 12

g00892965

8. Use Tooling (C) to remove retaining ring (10). Remove washer (11) and gear (12). Remove bearing assembly (13) and washer (14).
9. Repeat Step 8 for the other two gear assemblies.

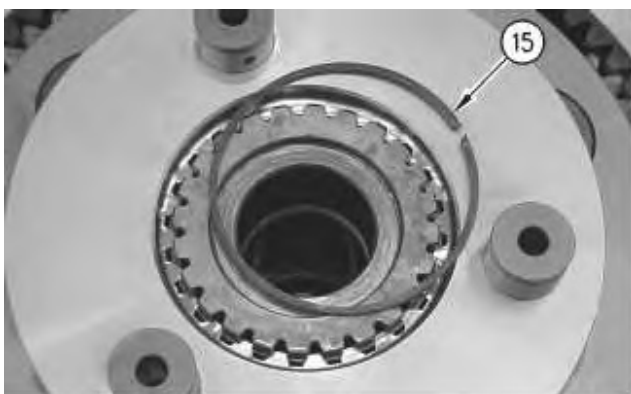

Illustration 13

g00892968

10. Remove retaining ring (15).

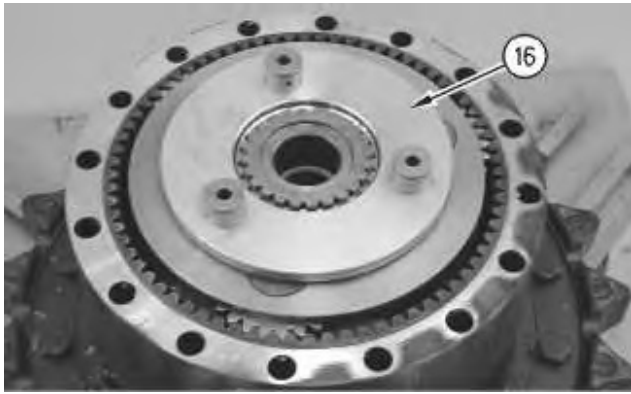

Illustration 14

g00892975

11. Remove carrier assembly (16).

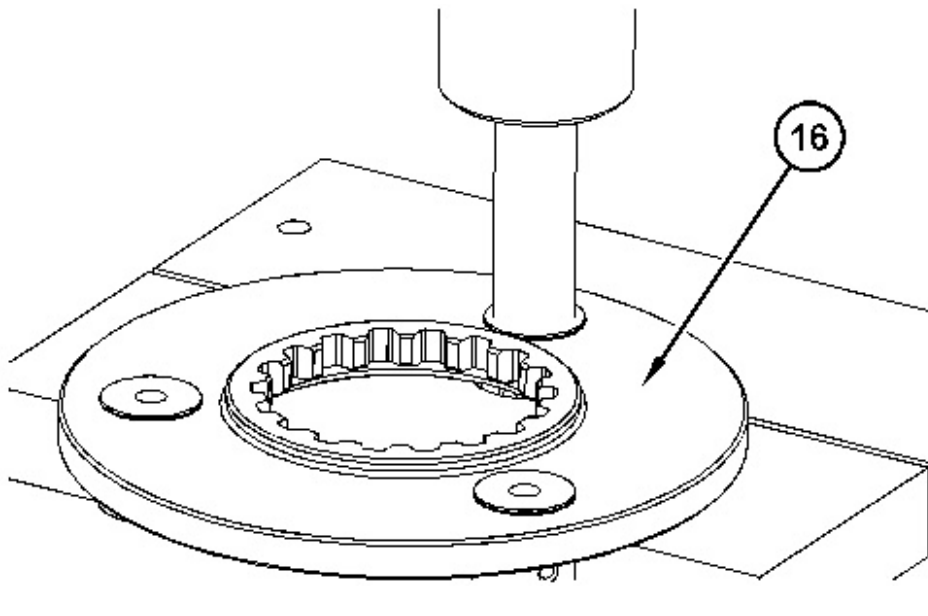

Illustration 15

g02408860

12. Use a suitable press to remove the shafts from carrier assembly (16).

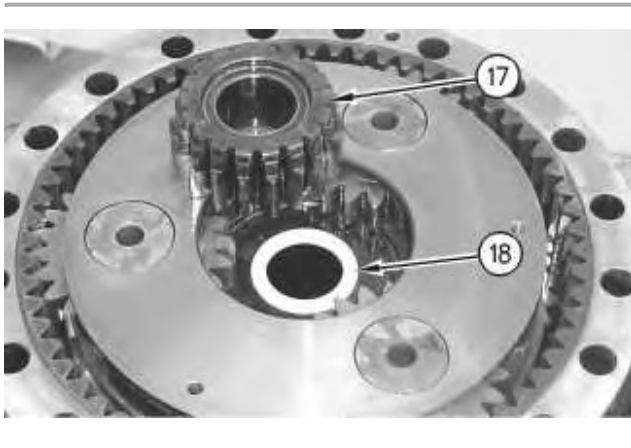

Illustration 16

g00892977

13. Remove gear (17) and spacer (18).

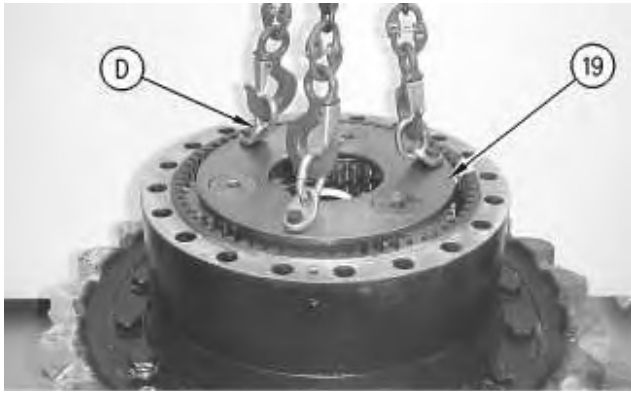

Illustration 17

g00892997

14. Use Tooling (D) and a suitable lifting device to remove planetary carrier (19). The weight of planetary carrier (19) is approximately 48 kg (105 lb).

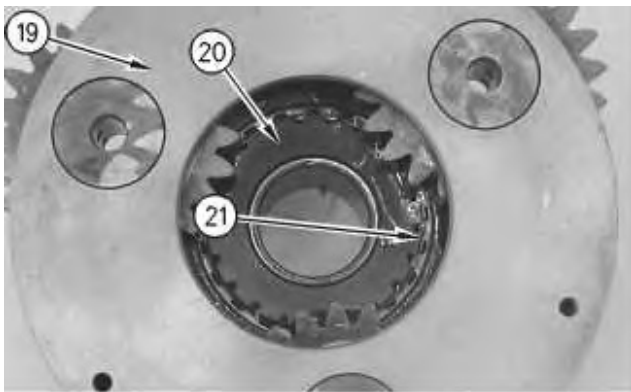

Illustration 18

g00893019

15. Remove retaining ring (21). Lift planetary carrier (19) off sun gear (20).



Illustration 19

g00896860

16. Drive spring pin (23) into planetary shaft (22).
-

Thank you so much for reading.
Please click the “Buy Now!”
button below to download the
complete manual.



After you pay.

You can download the most
perfect and complete manual in
the world immediately.

Our support email:

ebooklibonline@outlook.com