

SERIE N F4CE

TIER 3

Agricultural application

F4CE9484F*J600

Technical and Repair manual

Introduction

	Page
PREFACE TO USER'S GUIDELINE MANUAL	3
SYMBOLS	5
<input type="checkbox"/> Warnings	3
<input type="checkbox"/> Service operations	3
GENERAL WARNINGS	5
GENERAL WARNINGS ON THE ELECTRIC SYSTEM	7
<input type="checkbox"/> Bonding and screening	8
CONVERSIONS BETWEEN THE MAIN UNITS OF MEASUREMENT OF THE INTERNATIONAL SYSTEM AND MOST USED DERIVED QUANTITIES	9
KEY OF LECTURE OF THE HEADINGS AND FOOTNOTES	10

PREFACE TO USER'S GUIDELINE MANUAL

Manuals for repairs are split into Parts and Sections, each one of which is marked by a numeral; the contents of these sections are indicated in the general table of contents.

The sections dealing with things mechanic introduce the specifications, tightening torque values, tool lists, assembly detaching/reattaching operations, bench overhauling operations, diagnosis procedures and maintenance schedules.

The sections (or parts) of the electric/electronic system include the descriptions of the electric network and the assembly's electronic systems, wiring diagrams, electric features of components, component coding and the diagnosis procedures for the control units peculiar to the electric system.

Section 1 describes the engine illustrating its features and working in general.

Section 2 describes the type of fuel feed.

Section 3 relates to the specific duty and is divided in four separate parts:

1. Mechanical part, related to the engine overhaul, limited to those components with different characteristics based on the relating specific duty.

2. Electrical part, concerning wiring harness, electrical and electronic equipment with different characteristics based on the relating specific duty.

3. Maintenance planning and specific overhaul.

4. Troubleshooting part dedicated to the operators who, being entitled to provide technical assistance, shall have simple and direct instructions to identify the cause of the major inconveniences.

Sections 4 and 5 illustrate the overhaul operations of the engine overhaul on stand and the necessary equipment to execute such operations.

The appendix contains a list of the general safety regulations to be respected by all installation and maintenance engineers in order to prevent serious accidents taking place.

The manual uses proper symbols in its descriptions; the purpose of these symbols is to classify contained information. In particular, there have been defined a set of symbols to classify warnings and a set for assistance operations.

SYMBOLS - Warnings



Danger for persons

Missing or incomplete observance of these prescriptions can cause serious danger for persons' safety.



Danger of serious damage for the assembly

Failure to comply, both fully or in part, with such prescriptions will involve serious damage to the assembly and may sometimes cause the warranty to become null and void.



General danger

It includes the dangers of above described signals.



Environment protection

Moreover, it describes the correct actions to be taken to ensure that the assembly is used in such a way so as to protect the environment as much as possible.

NOTE It indicates an additional explanation for a piece of information.

Service operations

Example

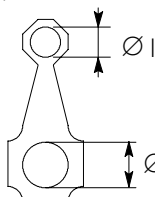

































Ø 1 = housing for connecting rod small end bush

Ø 2 = housing for connecting rod bearings



Tighten to torque

Tighten to torque + angular value

	Removal Disconnection		Intake
	Refitting Connection		Exhaust
	Removal Disassembly		Operation
	Fitting in place Assembly		Compression ratio
	Tighten to torque		Tolerance Weight difference
	Tighten to torque + angle value		Rolling torque
	Press or caulk		Rotation
	Regulation Adjustment		Angle Angular value
	Visual inspection Fitting position check		Preload
	Measurement Value to find Check		Number of revolutions
	Equipment		Temperature
	Surface for machining Machine finish		Pressure
	Interference Strained assembly		Oversized Higher than.... Maximum, peak
	Thickness Clearance		Undersized Less than.... Minimum
	Lubrication Damp Grease		Selection Classes Oversizing
	Sealant Adhesive		Temperature < 0 °C Cold Winter
	Air bleeding		Temperature > 0 °C Hot Summer

GENERAL WARNINGS



Warnings shown cannot be representative of all danger situations possibly occurring. Therefore, it is suggested to contact immediate superiors where a danger situation occurs which is not described.

Use both specific and general-purpose toolings according to the prescriptions contained in respective use and maintenance handbooks. Check use state and suitability of tools not subjected to regular check.

The manual handling of loads must be assessed in advance because it also depends, besides weight, on its size and on the path.

Handling by mechanical means must be with hoisters proper as for weight as well as for shape and volume. Hoisters, ropes and hooks used must contain clear indications on maximum carrying capacity acceptable. The use of said means is compulsorily permitted to authorised personnel only. Stay duly clear of the load, and, anyhow, never under it.

In disassembling operations, always observe provided prescriptions; prevent mechanical parts being taken out from accidentally striking workshop personnel.

Workshop jobs performed in pairs must always be performed in maximum safety; avoid operations which could be dangerous for the co-operator because of lack of visibility or of his/her not correct position.

Keep personnel not authorised to operations clear of working area.

You shall get familiar with the operating and safety instructions for the assembly prior to operating on the latter. Strictly follow all the safety indications found on the assembly.

Do not leave the running assembly unattended when making repairs.

When carrying out work on the assembly lifted off the ground, verify that the assembly is firmly placed on its supporting stands, and that the manual/automatic safety devices have been actuated in the event that the assembly is to be lifted by means of a hoist.

When you have to operate on assemblies powered by natural gas, follow the instructions contained in the document, as well as all the specific safety standards provided for.

Only remove radiator cap when the engine is cold by cautiously unscrewing it in order to let system residual pressure out.

Inflammable fuel and all inflammable fluids and liquids must be handled with care, according to what contained on harmful materials I 6-point cards. Refuelling must be performed outdoors with the engine off, avoiding lit cigarettes, free flames or sparks in order to prevent sudden fires/bursts. Adequately store inflammable, corrosive and polluting fluids and liquids according to what provided by regulations in force. Compulsorily avoid to use food containers to store harmful liquids. Avoid to drill or bore pressurised containers, and throw cloths impregnated with inflammable substances into suitable containers.

Worn out, damaged or consumable parts must be replaced by original spares.

During workshop activity, always keep the work place clean; timely clear or clean floors from accidental liquid or oil spots. Electric sockets and electric equipment necessary to perform repair interventions must meet safety rules.



Put on, where required by the intervention, garments and protections provided in accident prevention rules; contact with moving parts can cause serious injuries. Use suitable, preferably tight-fitted garments, and avoid to use jewels, scarves, etc.

Do not leave the engine in motion at workshop locations not provided with a pipe to scavenge exhaust gas outside.

Avoid to breathe fumes coming from heating or from paint welding because they can cause damages to health; operate outdoors or in suitably ventilated areas. Put on proper inspirator if paint powder is present.

Avoid contact with hot water or steam coming from the engine, radiator and pipings because they could cause serious burns. Avoid direct contact with liquids and fluids present in vehicle systems; where an accidental contact has occurred, refer to 16-point cards for provisions to make.



Clean the assemblies and carefully verify that they are intact prior to overhauling. Tidy up detached or disassembled parts with their securing elements (screws, nuts, etc.) into special containers.

Check for the integrity of the parts which prevent screws from being unscrewed: broken washers, dowels, clips, etc. Self-locking nuts with an insert made of nylon must always be replaced.

Avoid contact of rubber parts with diesel oil, petrol or other not compatible substances.

Before washing under pressure mechanical parts, protect electric connectors, and central units, if present.

Tightening screws and nuts must always be according to prescriptions; FPT commercial and assistance network is available to give all clarifications necessary to perform repair interventions not provided in this document.

Before welding:

- Disconnect all electronic central units, take power cable off battery positive terminal (connect it to chassis bonding) and detach connectors.
- Remove paint by using proper solvents or paint removers and clean relevant surfaces with soap and water.
- Await about 15 minutes before welding.
- Equip with suitable fire resistant protections to protect hoses or other components where fluids or other materials flow which may catch fire easily on welding.

Should the vehicle be subjected to temperatures exceeding 80°C (dryer ovens), disassemble drive electronic central units.



The disposal of all liquids and fluids must be performed with full observance of specific rules in force.

GENERAL WARNINGS ON THE ELECTRIC SYSTEM



If an intervention has to be made on the electric/electronic system, disconnect batteries from the system; in this case, always disconnect, as a first one, the chassis bonding cable from batteries negative terminal.

Before connecting the batteries to the system, make sure that the system is well isolated.

Disconnect the external recharging apparatus from the public utility network before taking apparatus pins off battery terminals.

Do not cause sparks to be generated in checking if the circuit is energised.

Do not use a test lamp in checking circuit continuity, but only use proper control apparatuses.

Make sure that the electronic devices wiring harnesses (length, lead type, location, strapping, connection to screening braiding, bonding, etc.) comply with FPT system and are carefully recovered after repair or maintenance interventions.

Measurements in drive electronic central units, plugged connections and electric connections to components can only be made on proper testing lines with special plugs and plug bushes. Never use improper means like wires, screwdrivers, clips and the like in order to avoid the danger of causing a short circuit, as well as of damaging plugged connections, which would later cause contact problems.



To start up the engine, do not use fast chargers. Start up must only be performed with either separate batteries or special truck.

A wrong polarisation of supply voltage in drive electronic central units (for instance, a wrong polarisation of batteries) can cause them to be destroyed.

Disconnect the batteries from the system during their recharging with an external apparatus.

On connecting, only screw up connector (temperature sensors, pressure sensors etc.) nuts at prescribed tightening torque.

Before disconnecting the junction connector from an electronic central unit, isolate the system.

Do not directly supply electronic central units servo components at nominal vehicle voltage.

Cables must be arranged such as to result to be parallel to reference plane, i.e. as close as possible to chassis/body structure.

Once the intervention on the electric system has been completed, recover connectors and wiring harnesses according to original arrangement.

NOTE Connectors present must be seen from cable side. Connectors views contained in the manual are representative of cable side.

Bonding and screening

Negative leads connected to a system bonded point must be both as short and possible and "star"-connected to each other, trying then to have their centering tidily and properly made (Figure 1, re. M).

Further, following warnings are to be compulsorily observed for electronic components:

- Electronic central units must be connected to system bonding when they are provided with a metallic shell.
- Electronic central units negative cables must be connected both to a system bonding point such as the dashboard opening bonding (avoiding "serial" or "chain" connections), and to battery negative terminal.
- Analog bonding (sensors), although not connected to battery negative system/terminal bonding, must have optimal isolation. Consequently, particularly considered must be parasitic resistances in lugs: oxidising, clinching defects, etc.
- Screened circuits braiding must only electrically contact the end towards the central unit entered by the signal (Figure 2).
- If junction connectors are present, unscreened section **d**, near them, must be as short as possible (Figure 2).
- Cables must be arranged such as to result to be parallel to reference plane, i.e. as close as possible to chassis/body structure.

Figure 1

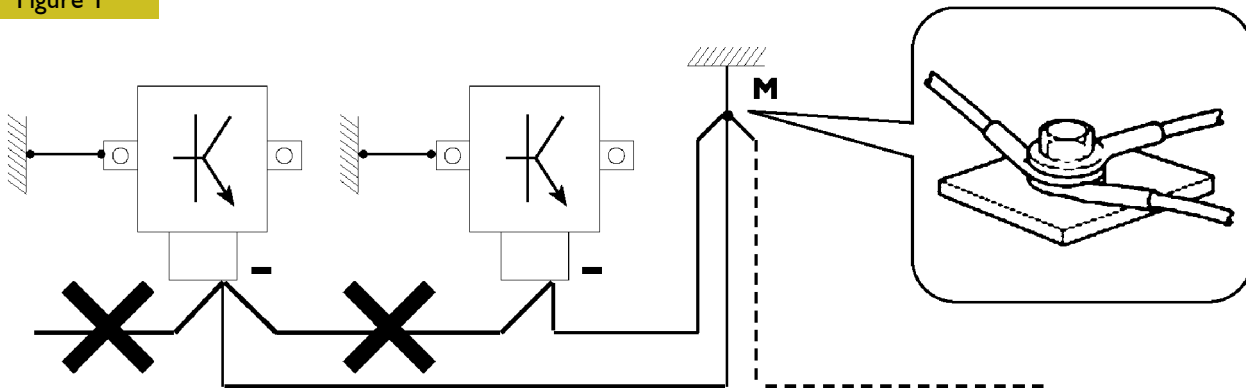

1. NEGATIVE CABLES "STAR" CONNECTION TO SYSTEM BONDING M

Figure 2

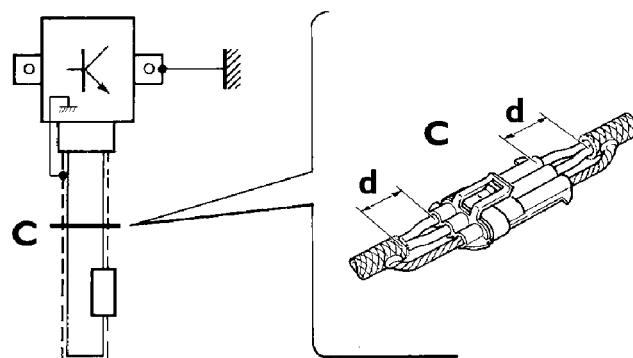

2. SCREENING THROUGH METALLIC BRAIDING OF A CABLE TO AN ELECTRONIC COMPONENT – C. CONNECTOR
d. DISTANCE → 0

88039

CONVERSIONS BETWEEN THE MAIN UNITS OF MEASUREMENT OF THE INTERNATIONAL SYSTEM AND MOST USED DERIVED QUANTITIES**Power**

1 kW	=	1.36 metric HP
1 kW	=	1.34 HP
1 metric HP	=	0.736 kW
1 metric HP	=	0.986 HP
1 HP	=	0.746 kW
1 HP	=	1.014 metric HP

Torque

1 Nm	=	0.1019 kgm
1 kgm	=	9.81 Nm

Revolutions per time unit

1 rad/s	=	1 rpm × 0.1046
1 rpm	=	1 rad/s × 9.5602

Pressure

1 bar	=	1.02 kg/cm ²
1 kg/cm ²	=	0.981 bar
1 bar	=	10 ⁵ Pa

Where accuracy is not particularly needed:

Nm unit is for the sake of simplicity converted into kgm according to ratio 10:1

1 kgm = 10 Nm;

bar unit is for the sake of simplicity converted into kg/cm² according to ratio 1:1

1 kg/cm² = 1 bar.

Temperature

0° C = 32° F

1° C = (1 × 1.8 + 32) ° F

KEY OF LECTURE OF THE HEADINGS AND FOOTNOTES

Type of vehicle	Section title	Page number
-----------------	---------------	-------------

MOTORI NEF F4HE

SEZIONE 4 - REVISIONE MECCANICA GENERALE 11

**REVISIONE MOTORE 4 E 6 CIL.
SMONTAGGIO DEL MOTORE AL BANCO**

La trattazione seguente prevede che il motore sia stato montato sul cavalletto rotativo e si sia proceduto alla rimozione di tutti i componenti specifici dell'applicazione Iveco Motors (vedere la Sezione 3 del presente manuale).

La sezione riguarda quindi tutte le più importanti procedure di revisione del basamento motore.

Le operazioni seguenti riguardano il motore 4 cilindri, ma risultano analoghe per il 6 cilindri.

Figura 1

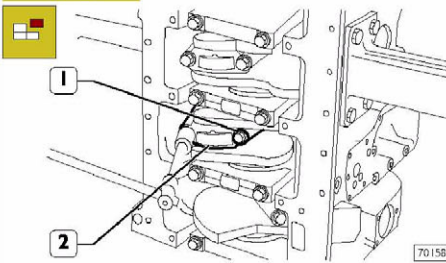

Svitare le viti di fissaggio (1) e rimuovere i cappelli di biella (2). Sfilare gli stantuffi completi di bielle dalla parte superiore del basamento.

NOTA Mantenere i semicuscinetti nei rispettivi alloggiamenti, poiché, in caso di un loro utilizzo, dovranno essere montati nella posizione riscontrata allo smontaggio.

Figura 2

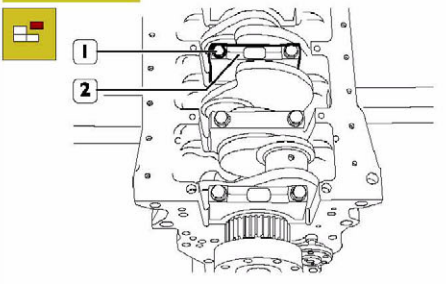

Rimuovere le viti (1) e smontare i cappelli di banco (2).

Print P2D32N003.1

Printout number

Language Publication

Figura 3

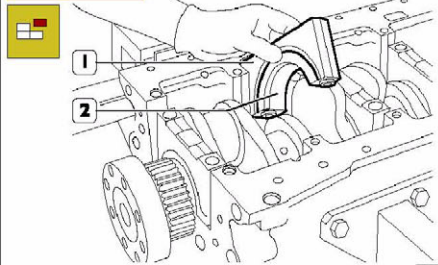

Il penultimo cappello di banco (1) e il relativo supporto (2) hanno il semicuscinetto (2) dotato di spallamento.

NOTA Le viti M12 dei cappelli di banco, devono essere sostituite se il diametro nominale della parte filettata che non lavora, presenta un diametro < 0,1 mm rispetto al valore nominale.

NOTA Annotare la posizione di montaggio dei semicuscinetti inferiori e superiori, poiché in caso di un loro riutilizzo, dovranno essere montati nella posizione riscontrata allo smontaggio.

Figura 4

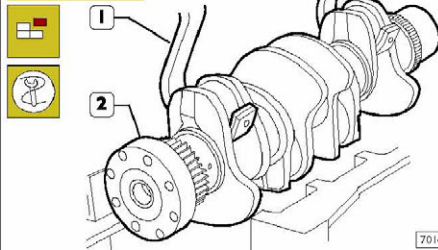

Con l'attrezzo 99360500 (1) e sollevatore rimuovere l'albero motore (2) dal basamento.

Figura 5

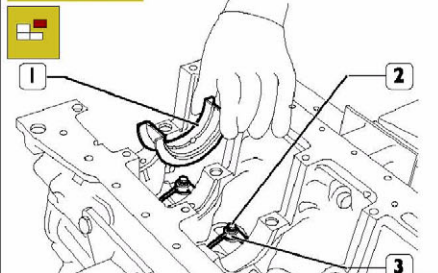

Smontare i semicuscinetti di banco (1). Rimuovere le viti (2) e smontare gli spruzzatori olio (3).

Base - Dicembre 2006
Revi - Febbraio 2007

Basic edition referred to month - year editorial phase closing

When month - year update is present (revi) to the basic edition

Part I
SERIE N F4CE

Section

General specifications

I

Fuel

2

G-Drive applications

3

Overhaul and technical specifications

4

Tools

5

Safety prescriptions

Appendix

UPDATING

Section	Description	Page	Date of revision

SECTION I

General Specifications

	Page
SCHMIERUNG	3
LUBRICATION	3
<hr/>	
OIL VAPOUR RECIRCULATING SYSTEM	4
<hr/>	
COOLING SYSTEM	5
<hr/>	
AIR INDUCTION BOOST DIAGRAM	6
<hr/>	
<input type="checkbox"/> Boosting version engines	6
<hr/>	
<input type="checkbox"/> Description	6
<hr/>	

LUBRICATION

Forced-circulation lubrication, is obtained by means of the oil lobe pump fitted in the front part of the basement, driven by the splined bush, keyed on the hold of the engine drive shaft.

From the pan, the lubrication oil flows to the driving shaft, to the camshaft and to the valve drive.

Lubrication circle also includes the heat exchanger, the turbo-blower for the turbo-compressed version and eventually the compressor for the compressed air system.

These components may often vary according to the specific duty.

Figure I

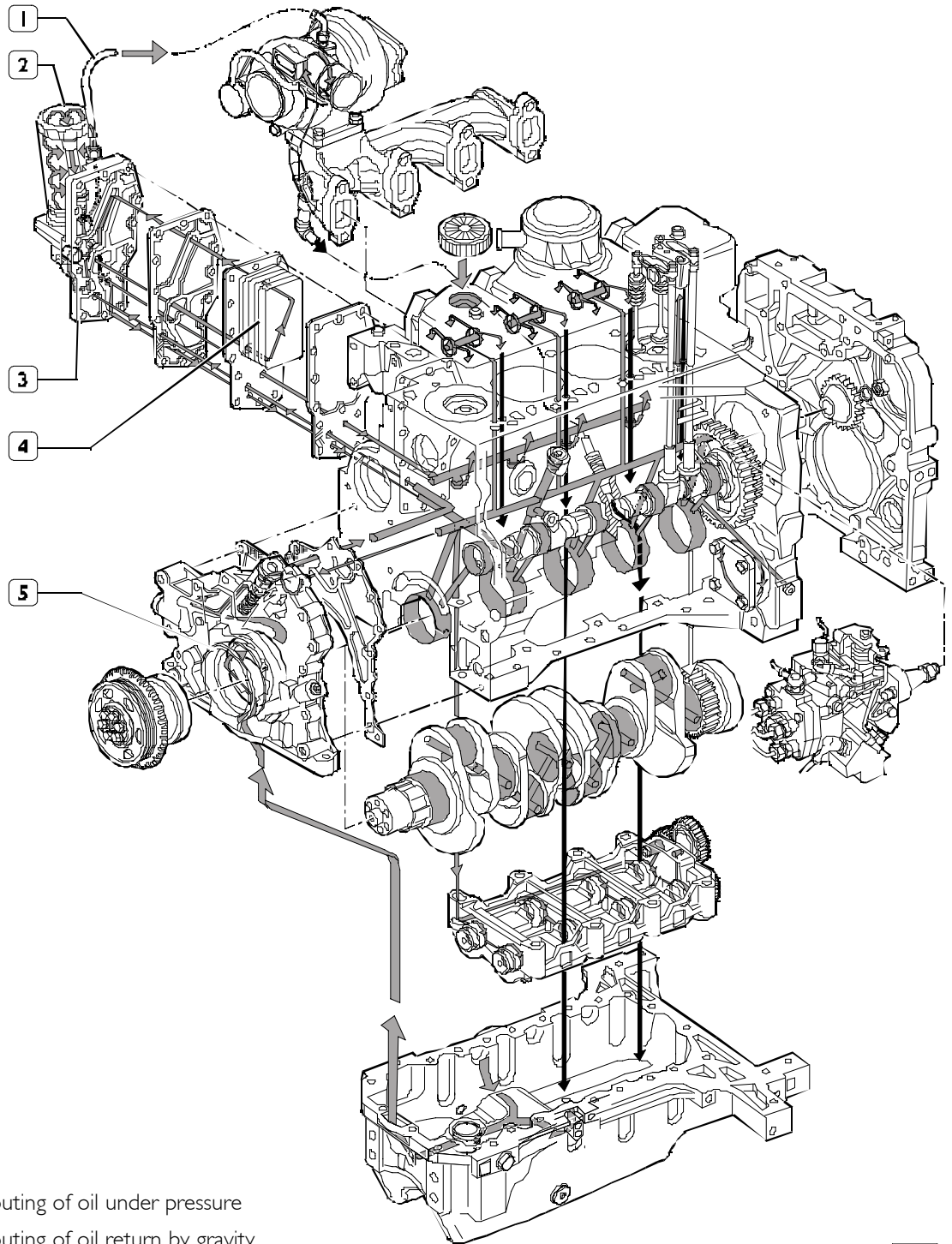

88203

LUBRICATION SYSTEM LAYOUT

I. Lubrication oil pipe to supercharger - 2. Oil filter - 3. Heat exchanger body - 4. Heat exchanger - 5. Oil rotary expansion pump.

Thank you so much for reading.
Please click the “Buy Now!”
button below to download the
complete manual.



After you pay.

You can download the most
perfect and complete manual in
the world immediately.

Our support email:

ebooklibonline@outlook.com