

PART NO. EM18M-1-1

HITACHI

Operator's Manual

EX 3600-6

Hydraulic Excavator

Serial No 001002 and up

MACHINE NUMBERS

MACHINE TYPE AND SERIAL NUMBER

MODEL/TYPE: _____

PRODUCT IDENTIFICATION NUMBER: _____

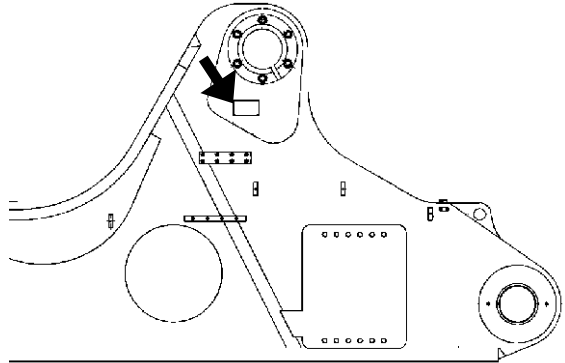

M18M-00-001

PRODUCT IDENTIFICATION NUMBER

PRODUCT IDENTIFICATION NUMBER: _____

 NOTE:

HCM18M00P00001001

Marks to indicate the start and end of the PIN

PRODUCT IDENTIFICATION NUMBER (PIN)

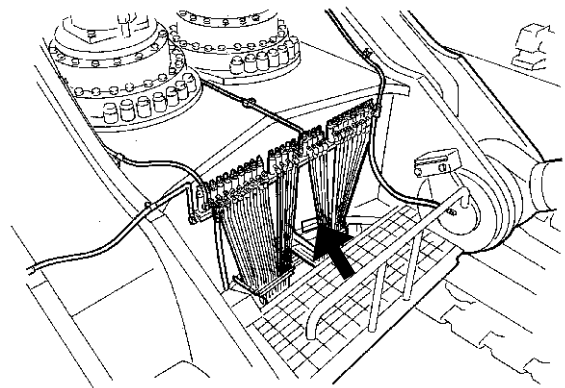

M146-07-018

ENGINE TYPE AND SERIAL NUMBER

TYPE: _____

MFG. NO. _____

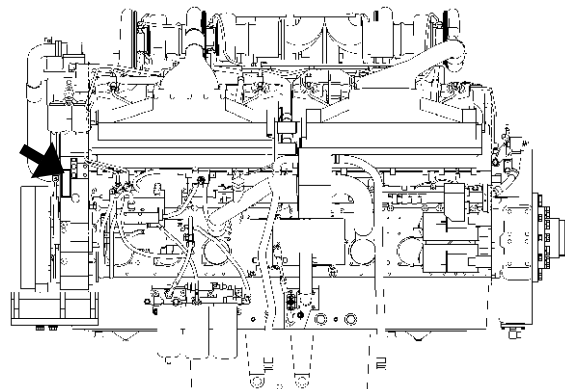

M18M-00-002

TRAVEL MOTOR TYPE AND SERIAL NUMBER

TYPE: _____

MFG. NO.(LEFT FRONT) : _____

MFG. NO.(LEFT REAR) : _____

MFG. NO.(RIGHT FRONT) : _____

MFG. NO.(RIGHT REAR) : _____

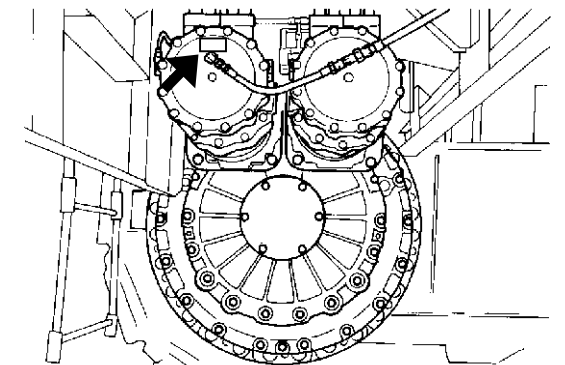

M145-07-079

MACHINE NUMBERS

SWING MOTOR TYPE AND SERIAL NUMBER

TYPE: _____

MFG. NO.(FRONT LEFT) : _____

MFG. NO.(FRONT RIGHT): _____

MFG. NO.(REAR LEFT): _____

MFG. NO.(REAR RIGHT): _____

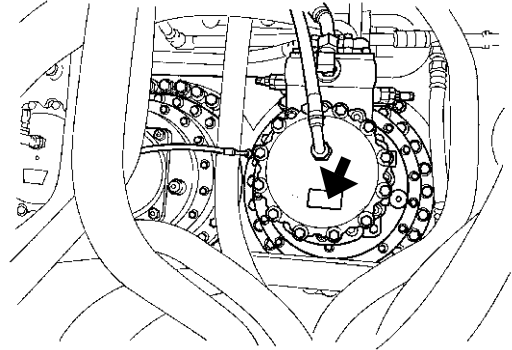

M146-07-028

HYDRAULIC PUMP TYPE AND SERIAL NUMBER

TYPE: _____

MFG. NO.(1, 2): _____

MFG. NO.(3, 4): _____

MFG. NO.(5, 6): _____

MFG. NO.(7, 8): _____

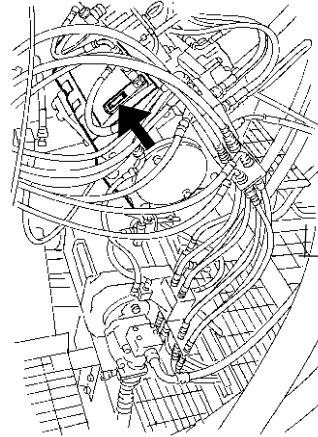

M146-07-059

FRONT TYPE AND SERIAL NUMBER (LOADING SHOVEL)

TYPE: _____

MFG. NO.: _____

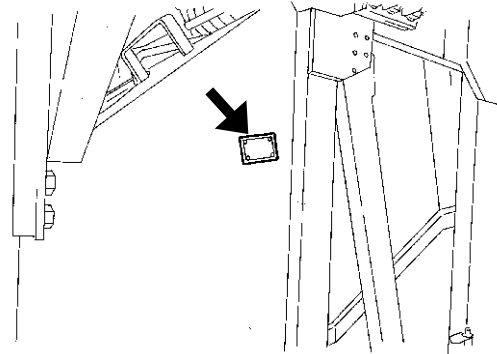

M146-07-060

BUCKET TYPE AND SERIAL NUMBER (LOADING SHOVEL)

TYPE: _____

MFG. NO.: _____

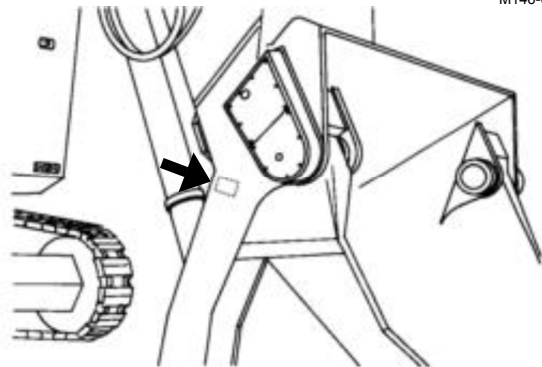

M117-12-003

MACHINE NUMBERS

FRONT TYPE AND SERIAL NUMBER (BACKHOE BOOM)

TYPE: _____

MFG. NO.: _____

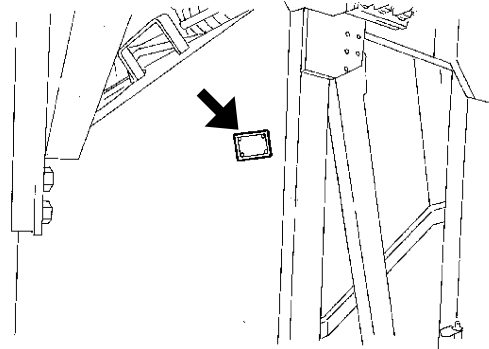

M146-07-060

FRONT TYPE AND SERIAL NUMBER (BACKHOE ARM)

TYPE: _____

MFG. NO.: _____

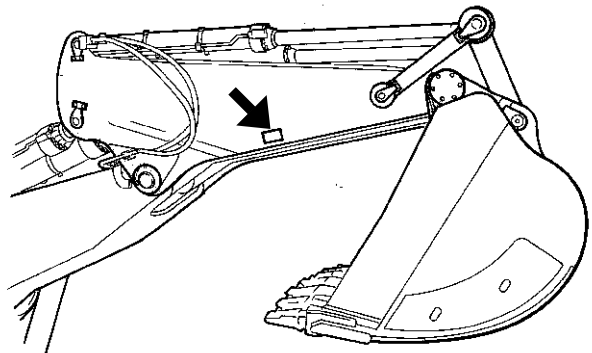

M146-07-061

BUCKET TYPE AND SERIAL NUMBER (BACKHOE)

TYPE: _____

MFG. NO.: _____

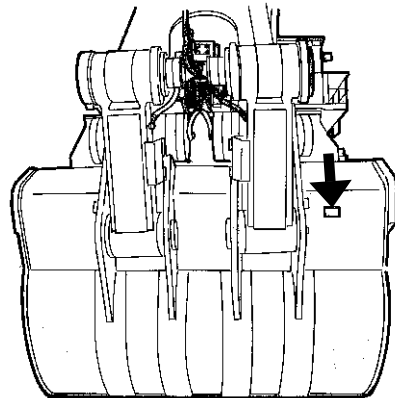

M146-01-020

CONTROL VALVE TYPE AND SERIAL NUMBER

TYPE: _____

MFG. NO.(UPPER LEFT): _____

MFG. NO.(UPPER RIGHT): _____

MFG. NO.(LOWER LEFT): _____

MFG. NO.(LOWER RIGHT): _____

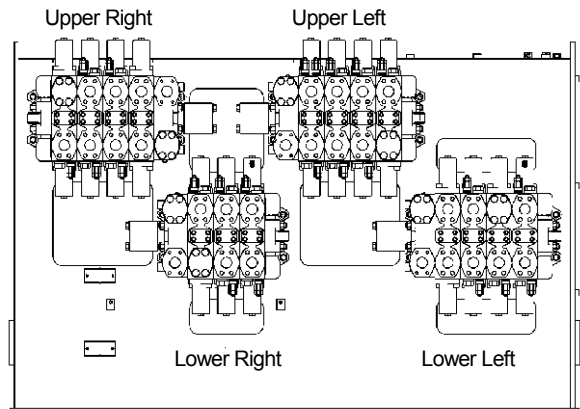

M18M-00-003

MACHINE NUMBERS

MEMO

A series of horizontal dotted lines for writing.

CONTENTS

MACHINE NUMBERS

SAFETY

Recognize Safety Information.....	S-1
Understand Signal Words.....	S-1
Follow Safety Instructions.....	S-2
Prepare for Emergencies.....	S-2
Wear Protective Clothing.....	S-3
Protect Against Noise.....	S-3
Inspect Machine.....	S-3
General Precautions for Cab.....	S-4
Use Handholds and Steps.....	S-5
Adjust the Operator's Seat.....	S-5
Fasten Your Seat Belt.....	S-6
Move and Operate Machine Safely.....	S-6
Handle Starting Aids Safely.....	S-6
Operate Only from Operator's Seat.....	S-7
Jump Starting.....	S-7
Keep Riders Off Machine.....	S-7
Investigate Job Site Beforehand.....	S-8
Protect Against Falling Stones and Debris.....	S-8
Provide Signals for Jobs Involving Multiple Numbers of Machines.....	S-9
Confirm Direction of Machine to be Driven.....	S-9
Drive Machine Safely.....	S-10
Avoid Injury from Rollaway Accidents.....	S-11
Avoid Injury from Back-Over and Swing Accidents.....	S-12
Keep Person Clear from Working Area.....	S-13
Never Position Bucket Over Anyone.....	S-13
Avoid Undercutting.....	S-13
Avoid Tipping.....	S-14
Never Undercut a High Bank.....	S-14
Dig with Caution.....	S-15
Operate with Caution.....	S-15
Avoid Power Lines.....	S-15
Object Handling.....	S-16
Protect Against Flying Debris.....	S-16
Park Machine Safely.....	S-17
Handle Fluids Safely – Avoid Fires.....	S-17
Practice Safe Maintenance.....	S-18
Warn Others of Service Work.....	S-19
Support Machine Properly.....	S-19
Stay Clear of Moving Parts.....	S-19
Prevent Parts from Flying.....	S-20
Store Attachments Safely.....	S-20
Prevent Burns.....	S-21
Replace Rubber Hoses Periodically.....	S-21
Avoid High-Pressure Fluids.....	S-22
Prevent Fires.....	S-23
Evacuating in Case of Fire.....	S-24
Beware of Exhaust Fumes.....	S-24
Precautions for Welding and Grinding.....	S-25
Avoid Heating Near Pressurized Fluid Lines.....	S-25
Avoid Applying Heat to Lines Containing Flammable Fluids.....	S-25

Remove Paint Before Welding or Heating.....	S-26
Beware of Asbestos Dust.....	S-26
Prevent Battery Explosions.....	S-27
Service Air Conditioning System Safely.....	S-27
Handle Chemical Products Safely.....	S-28
Dispose of Waste Properly.....	S-28

SAFETY SIGNS.....	S-29
--------------------------	-------------

COMPONENTS NAME.....	1-1
-----------------------------	------------

HANDLING STAIRWAY/EMERGENCY ROPE

Using Stairway.....	1-2
Operating Stairway.....	1-2
Emergency Escape.....	1-5
Emergency Exit.....	1-6
Evacuating in Case of Fire.....	1-6

OPERATOR'S STATION

Cab Features.....	1-8
Monitor Display.....	1-9
Starting Check Screen.....	1-9
Meter Check Screen.....	1-10
Tachometer.....	1-11
Coolant Temperature Gauge.....	1-11
Hydraulic Oil Temperature Gauge.....	1-11
Fuel Gauge.....	1-11
Engine Oil Pressure Gauge.....	1-12
Engine Oil Temperature Gauge.....	1-12
Hour Meter.....	1-12
Warning Indicators.....	1-12
Alternator Indicator.....	1-12
Pump Transmission Oil Level Indicator.....	1-13
Engine Stop Indicator.....	1-13
Engine Oil Pressure Indicator.....	1-13
Coolant Overheat Indicator.....	1-13
Coolant Level Indicator.....	1-14
Engine Over Run Indicator.....	1-14
Fuel Temperature Indicator.....	1-14
Hydraulic Oil Level Indicator.....	1-14
Stop Valve Indicator.....	1-15
Auto-Lubrication Indicator.....	1-15
Fast-Filling Indicator.....	1-16
Emergency Engine Stop Indicator.....	1-16
Tension Indicator.....	1-16
Electric Lever Indicator.....	1-16
Caution Indicators.....	1-17
Exhaust Temperature Indicator.....	1-17
Engine Warning Indicator.....	1-17
Hydraulic Oil Overheat Indicator.....	1-17
Pump Contamination Indicator.....	1-17
Stairway Position Indicator.....	1-18
Air Cleaner Restriction Indicator.....	1-18
Electrical Equipment Box Indicator.....	1-18
Status Indicators.....	1-18
Auto-Idle Indicator.....	1-18

CONTENTS

Travel Mode Indicator	1-19
Prelub Indicator	1-19
Left Console.....	1-20
Warning Lamp.....	1-20
Caution Lamp	1-20
Key Pad	1-20
Monitor Contrast Switch	1-20
Wiper Switch	1-21
Washer Switch	1-21
Wiper Delay Selector Switch	1-21
Air Conditioners	1-22
Designations and Functions of Controls	1-23
Cooling	1-25
Heating	1-25
Dehumidifying and Heating	1-25
Defrosting	1-26
Blower Operation without Cooling or Heating	1-26
Ventilation the Cab	1-26
AM/FM Radio Operation	1-27
Digital Clock Setting Procedure	1-28
Right Console	1-29
Key Switch	1-29
Emergency Engine Stop Switch	1-30
Engine Start Switch	1-30
Engine Stop Switch	1-30
Engine Speed Control Dial	1-31
Work Light Switch.....	1-32
Dome Light Switch.....	1-33
Maintenance Light Switch.....	1-34
Entrance Light Switch.....	1-35
Travel Mode Switch	1-36
Auto-Idle Switch.....	1-36
Buzzer Stop Switch.....	1-37
Fast-Filling System	1-38
Rear Console.....	1-39
Horn Switch	1-40
Adjusting the Seat.....	1-41
Seat Belt	1-44
Cab Door Release Button.....	1-45
Opening Cab Left Window.....	1-45

BREAK-IN

Observe Machine Closely.....	2-1
Every 10 Hours or Each Shift	2-1
After the First 50 Hours	2-2

OPERATING THE ENGINE

Inspect Machine Daily Before Starting.....	3-1
Before Turning Power ON	3-2
Turning Power ON	3-3
Starting the Engine	3-8
Starting in Cold Weather	3-9
Check Instruments After Starting	3-10
Using Booster Batteries	3-11
Stopping the Engine	3-13

Emergency Engine Stop Switch.....	3-14
Engine Stop Switches	3-15

DRIVING THE MACHINE

Drive the Machine Carefully	4-1
Steering the Machine Using Pedals	4-2
Steering the Machine Using Levers	4-3
Travel Mode Switch.....	4-4
Travel Alarm.....	4-5
Traveling	4-6
Operating on Soft Ground	4-7
Raise One Track Using Boom and Arm.....	4-7
Towing Machine a Short Distance	4-8
Operating Ground Condition	4-9
Precautions for Traveling on Slopes	4-10
Parking the Machine on Slopes	4-11
Parking the Machine	4-11

OPERATING THE MACHINE

Control Lever (ISO Pattern Backhoe)	5-1
Control Lever (HITACHI Pattern Backhoe)	5-2
Control Lever (ISO Pattern Loading Shovel)	5-3
Control Lever (HITACHI Pattern Loading Shovel)	5-4
Bucket Open-Close Pedals (Loading Shovel).....	5-5
Pilot Control Shut-Off Lever	5-6
Engine Speed Control	5-7
Auto-Idle	5-8
Warming-Up Operation	5-9
Warming-Up the Cylinders and Motors.....	5-10
Precautions for Operations	5-11
Operate the Machine Safely.....	5-12
Operating Backhoe	5-13
Grading Operation.....	5-13
Avoid Abusive Operation.....	5-14
Operating Tips.....	5-15
Avoid Swinging Bucket to Move Objects.....	5-15
Loading Shovel Operation.....	5-16
Prohibited Operation	5-16
Object Handling.....	5-18
Overnight Storage Instructions.....	5-19

MAINTENANCE

Correct Maintenance and Inspection Procedures....	7-1
Check the Hour Meter Regularly.....	7-2
Use Correct Fuels and Lubricants	7-2
Prepare Machine for Maintenance	7-3
Open Access Doors for Service.....	7-5
Inspection/Maintenance Lights.....	7-6
Use a Chain to Prevent Falling Accidents	7-7
Electric Pump (Optional)	7-8
Construction Outline.....	7-10
Hydraulic System	7-11
Periodic Replacement of Parts	7-14
Periodic Replacement of Rubber Hoses	7-15
Maintenance Interval Guide	7-20

CONTENTS

A. Greasing	7-24	Check DCA4 Concentration in Coolant.....	7-86
Loading Shovel Front Joint Pins	7-25	Replace Coolant Filter	7-94
Backhoe Front Joint Pins	7-28	Change Coolant	7-95
Swing Bearing	7-31	Clean Radiator, After Cooler Interior.....	7-95
Swing Internal Gear.....	7-32	Clean Radiator, After Cooler Core	7-97
Center Joint	7-33	H. Air Conditioner	7-98
Operating the Lubricator.....	7-34	Recirculation Air Filter	7-98
B. Engine	7-36	Ventilation Air Filter.....	7-99
Engine Oil Level in Engine Oil Pan.....	7-37	Check Refrigerant Quantity.....	7-100
Check LED Monitor Signal		Check Compressor Belt Tension	7-101
(on Reserve Tank)	7-38	Clean Condenser Core	7-102
Change Engine Oil in Engine Oil Pan.....	7-39	Check Tightening Torque	7-103
Replace Engine Oil Filters	7-39	Seasonal Maintenance	7-104
C. Transmission	7-43	I. Electrical System	7-105
Pump Transmission Gear	7-44	Batteries	7-105
Pump Transmission Oil Level.....	7-44	Replace Batteries.....	7-109
Change Oil.....	7-45	Replacing Fuses	7-110
Replace Filter	7-46	Power Source Terminal	7-113
Clean Breather	7-46	High Current Fuse.....	7-114
Swing Reduction Gear.....	7-47	Check Electrical Cables and	
Check Oil Level	7-47	Wire Harnesses for Short Circuits	7-116
Change Gear Oil.....	7-48	Check Emergency Engine Stop Switch	7-118
Clean Breather	7-48	J. Miscellaneous	7-119
Travel Reduction Gear	7-49	Check Bucket Teeth	7-120
Check Oil Level	7-49	Inspect Emergency Evacuation	
Change Gear Oil.....	7-50	Equipment and Hanger.....	7-122
D. Hydraulic System.....	7-51	Auto-Lubrication System	7-123
Inspection and Maintenance		Check and Replace Seat Belt.....	7-127
of Hydraulic Equipment	7-52	Check Windshield Washer Fluid Lever.....	7-127
Check Hydraulic Oil Level	7-54	Clean Air Horn Compressor Filter.....	7-128
Drain Hydraulic Oil Tank Sump	7-55	Check and Adjust Track Sag	7-129
Change Hydraulic Oil.....	7-56	Check Accumulator and Track	
Replace Full-Flow Filter and Drain Filter	7-59	Adjuster Cylinder Circuit	7-131
Replace Bypass Filter.....	7-61	Check Side Frame Area	7-131
Replace Pilot Oil Filter	7-63	Check Tightening Torque of Bolts	
Suction Filter	7-65	and Nuts.....	7-132
Replace Suction Filter	7-66	MAINTENANCE UNDER SPECIAL	
Replace High-Pressure Strainer.....	7-67	ENVIRONMENTAL CONDITIONS	
Clean Oil Cooler Core	7-68	Maintenance Under Special	
Check Hoses and Lines	7-69	Environmental Conditions	9-1
Service Recommendations for		STORAGE	
Hydraulic Fittings	7-72	Storing the Machine	10-1
E. Fuel System.....	7-74	Removing the Machine from Storage	10-2
Drain Fuel Tank Sump	7-76	Transporting the Machine	10-2
Drain Fuel Filter Sediment.....	7-76	TROUBLESHOOTING	
Replace Fuel Element	7-77	Cummins Fault Code Lamps and	
Replace Fuel Filter	7-78	Diagnostic Switches	11-1
Check Fuel Hoses	7-79	Engine	11-2
Clean Fuel Cooler Core.....	7-81	Electrical System.....	11-6
Clean Fuel Tank Breather	7-81	Mode Selection	11-9
F. Air Cleaner.....	7-82	Hydraulic System	11-9
Clean Air Cleaner Outer Element.....	7-82	Auto-Idle	11-12
Replace Air Cleaner Outer			
and Inner Elements	7-82		
G. Cooling System	7-84		
Check Coolant Level	7-85		

CONTENTS

SPECIFICATIONS

Specifications	12-1
Working Range (Loading Shovel).....	12-2
Working Range (Backhoe)	12-3

INDEX	14-1
--------------------	------

SAFETY

RECOGNIZE SAFETY INFORMATION

- These are the **SAFETY ALERT SYMBOLS**.
 - When you see these symbols on your machine or in this manual, be alert to the potential for personal injury.
 - Follow recommended precautions and safe operating practices.

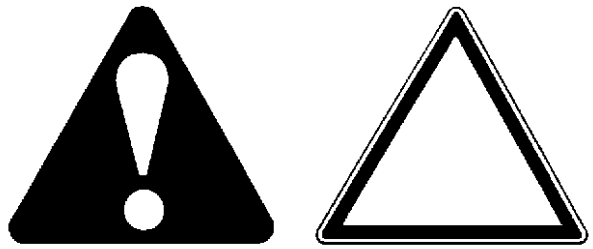

SA-688

001-E01A-0001

UNDERSTAND SIGNAL WORDS

- On machine safety signs, signal words designating the degree or level of hazard - **DANGER**, **WARNING**, or **CAUTION** - are used with the safety alert symbol.
 - **DANGER** indicates an imminently hazardous situation which, if not avoided, will result in death or serious injury.
 - **WARNING** indicates a potentially hazardous situation which, if not avoided, could result in death or serious injury.
 - **CAUTION** indicates a potentially hazardous situation which, if not avoided, may result in minor or moderate injury.
 - **DANGER** or **WARNING** safety signs are located near specific hazards. General precautions are listed on **CAUTION** safety signs.
 - Some safety signs don't use any of the designated signal words above after the safety alert symbol are occasionally used on this machine.



IMPORTANT



SA-1223

- To avoid confusing machine protection with personal safety messages, a signal word **IMPORTANT** indicates a situation which, if not avoided, could result in damage to the machine.
-  **NOTE** indicates an additional explanation for an element of information.

002-E01A-1223

SAFETY

FOLLOW SAFETY INSTRUCTIONS

- Carefully read and follow all safety signs on the machine and all safety messages in this manual.
- Safety signs should be installed, maintained and replaced when necessary.
 - If a safety sign or this manual is damaged or missing, order a replacement from your authorized dealer in the same way you order other replacement parts (be sure to state machine model and serial number when ordering).
- Learn how to operate the machine and its controls correctly and safely.
- Allow only trained, qualified, authorized personnel to operate the machine.
- Keep your machine in proper working condition.
 - Unauthorized modifications of the machine may impair its function and/or safety and affect machine life.
- The safety messages in this SAFETY chapter are intended to illustrate basic safety procedures of machines. However it is impossible for these safety messages to cover every hazardous situation you may encounter. If you have any questions, you should first consult your supervisor and/or your authorized dealer before operating or performing maintenance work on the machine.

003-E01B-0003

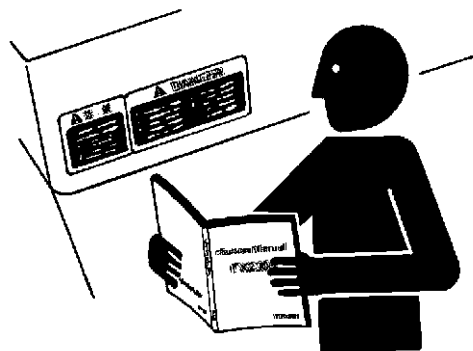

SA-003

PREPARE FOR EMERGENCIES

- Be prepared if a fire starts or if an accident occurs.
 - Keep a first aid kit and fire extinguisher on hand.
 - Thoroughly read and understand the label attached on the fire extinguisher to use it properly.
 - To ensure that a fire-extinguisher can be always used when necessary, check and service the fire-extinguisher at the recommended intervals as specified in the fire-extinguisher manual.
- Establish emergency procedure guidelines to cope with fires and accidents.
- Keep emergency numbers for doctors, ambulance service, hospital, and fire department posted near your telephone.

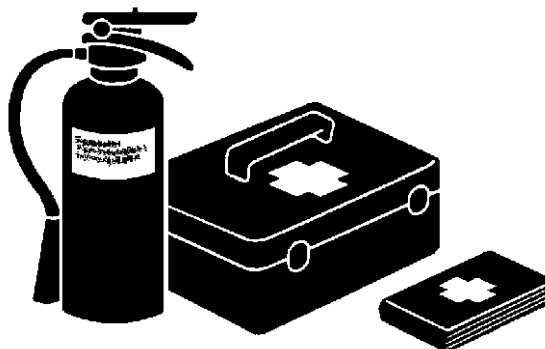

SA-437

004-E01A-0437

SAFETY

WEAR PROTECTIVE CLOTHING

- Wear close fitting clothing and safety equipment appropriate to the job.

You may need:

- A hard hat
- Safety shoes
- Safety glasses, goggles, or face shield
- Heavy gloves
- Hearing protection
- Reflective clothing
- Wet weather gear
- Respirator or filter mask.

Be sure to wear the correct equipment and clothing for the job. Do not take any chances.

- Avoid wearing loose clothing, jewelry, or other items that can catch on control levers or other parts of the machine.
- Operating equipment safely requires the full attention of the operator. Do not wear radio or music headphones while operating the machine.

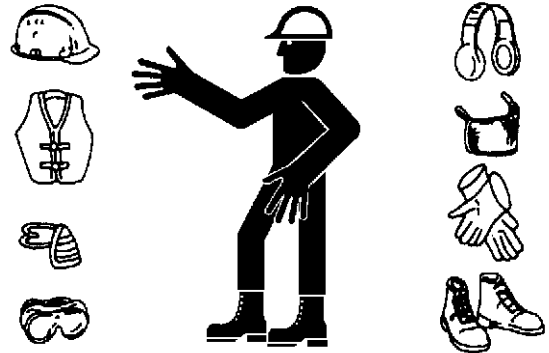

SA-438

005-E01A-0438

PROTECT AGAINST NOISE

- Prolonged exposure to loud noise can cause impairment or loss of hearing.
- Wear a suitable hearing protective device such as earmuffs or earplugs to protect against objectionable or uncomfortably loud noises.



006-E01A-0434

SA-434

INSPECT MACHINE

- Inspect your machine carefully each day or shift by walking around it before you start it to avoid personal injury.
- In the walk-around inspection, be sure to cover all points described in the “PRE-START INSPECTION” chapter in the operator’s manual.



007-E01A-0435

SA-435

SAFETY

GENERAL PRECAUTIONS FOR CAB

- Before entering the cab, thoroughly remove all dirt and/or oil from the soles of your work boots. If any controls such as a pedal is operated while with dirt and/or oil on the soles of the operator's work boots the operator's foot may slip off the pedal, possibly resulting in a personal accident.
- Do not leave parts and/or tools lying around the operator's seat. Store them in their specified locations.
- Avoid storing transparent bottles in the cab. Do not attach any transparent type window decorations on the windowpanes as they may focus sunlight, possibly starting a fire.
- Refrain from listening to the radio, or using music headphones or mobile telephones in the cab while operating the machine.
- Keep all flammable objects and/or explosives away from the machine.
- After using the ashtray, always cover it to extinguish the match and/or tobacco.
- Do not leave cigarette lighters in the cab. When the temperature in the cab increases, the lighter may explode.

524-E01A-0000

SAFETY

USE HANDHOLDS AND STEPS

- Falling is one of the major causes of personal injury.
 - When you get on and off the machine, always face the machine and maintain a three-point contact with the steps and handrails.
 - Do not use any controls as handholds.
 - Never jump on or off the machine. Never mount or dismount a moving machine.
 - Be careful of slippery conditions on platforms, steps, and handrails when leaving the machine.



SA-439

008-E01A-0439

ADJUST THE OPERATOR'S SEAT

- A poorly adjusted seat for either the operator or for the work at hand may quickly fatigue the operator leading to misoperations.
 - The seat should be adjusted whenever changing the operator for the machine.
 - The operator should be able to fully depress the pedals and to correctly operate the control levers with his back against the seat back.
 - If not, move the seat forward or backward, and check again.



SA-378

009-E01A-0378

SAFETY

FASTEN YOUR SEAT BELT

- If the machine should overturn, the operator may become injured and/or thrown from the cab. Additionally the operator may be crushed by the overturning machine, resulting in serious injury or death.
- Prior to operating the machine, thoroughly examine webbing, buckle and attaching hardware. If any item is damaged or worn, replace the seat belt or component before operating the machine.
- Be sure to remain seated with the seat belt securely fastened at all times when the machine is in operation to minimize the chance of injury from an accident.
- We recommend that the seat belt be replaced every three years regardless of its apparent condition.



SA-237

010-E01A-0237

MOVE AND OPERATE MACHINE SAFELY

- Bystanders can be run over.
- Take extra care not to run over bystanders. Confirm the location of bystanders before moving, swinging, or operating the machine.
- Always keep the travel alarm and horn in working condition (if equipped). It warns people when the machine starts to move.
- Use a signal person when moving, swinging, or operating the machine in congested areas. Coordinate hand signals before starting the machine.

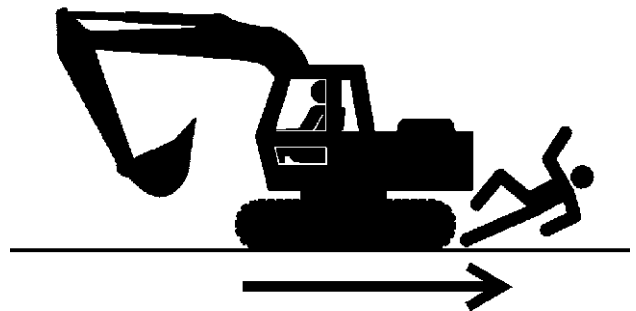

SA-426

011-E01A-0426

HANDLE STARTING AIDS SAFELY

Starting fluid:

- Starting fluid is highly flammable.
- Keep all sparks and flame away when using it.
- Keep starting fluid well away from batteries and cables.
- Remove container from machine if engine does not need starting fluid.
- To prevent accidental discharge when storing a pressurized container, keep the cap on the container, and store it in a cool, well-protected location.
- Do not incinerate or puncture a starting fluid container.



SA-293

036-E01A-0293-3

SAFETY

OPERATE ONLY FROM OPERATOR'S SEAT

- Inappropriate engine starting procedures may cause the machine to runaway, possibly resulting in serious injury or death.
- Start the engine only from the operator's seat.
- NEVER start the engine while standing on the track or on ground.
- Do not start engine by shorting across starter terminals.
- Before starting the engine, confirm that all control levers are in neutral.



SA-444

012-E01B-0444

JUMP STARTING

- Battery gas can explode, resulting in serious injury.
- If the engine must be jump started, be sure to follow the instructions shown in the "OPERATING THE ENGINE" chapter.
- The operator must be in the operator's seat so that the machine will be under control when the engine starts. Jump starting is a two-person operation.
- Never use a frozen battery.
- Failure to follow correct jump starting procedures could result in a battery explosion or a runaway machine.

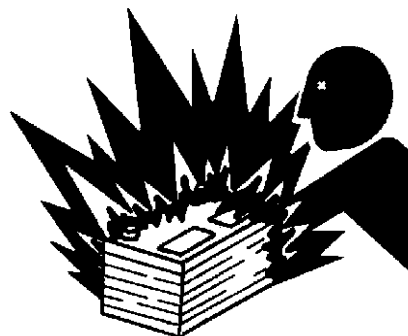

SA-032

S013-E01A-0032

KEEP RIDERS OFF MACHINE

- Riders on machine are subject to injury such as being struck by foreign objects and being thrown off the machine.
- Only allow the operator on the machine. Keep riders off.
- Riders also obstruct the operator's view, resulting in the machine being operated in an unsafe manner.

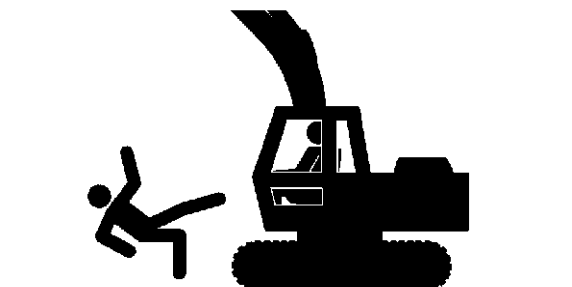

SA-379

014-E01B-0379

SAFETY

INVESTIGATE JOB SITE BEFOREHAND

- When working at the edge of an excavation or on a road shoulder, the machine could tip over, possibly resulting in serious injury or death.
- Investigate the configuration and ground conditions of the job site beforehand to prevent the machine from falling and to prevent the ground, stockpiles, or banks from collapsing.
- Make a work plan. Use machines appropriate to the work and job site.
- Reinforce ground, edges, and road shoulders as necessary. Keep the machine well back from the edges of excavations and road shoulders.
- When working on an incline or on a road shoulder, employ a signal person as required.
- Confirm that your machine is equipped a FOPS cab before working in areas where the possibility of falling stones or debris exist.
- When the footing is weak, reinforce the ground before starting work.
- When working on frozen ground, be extremely alert. As ambient temperatures rise, footing becomes loose and slippery.
- Beware the possibility of fire when operating the machine near flammable objects such as dry grass.



SA-380

015-E01A-0380

PROTECT AGAINST FALLING STONES AND DEBRIS

- Confirm that your machine is FOPS cab equipped before working in areas where the possibility of falling stones or debris exist.

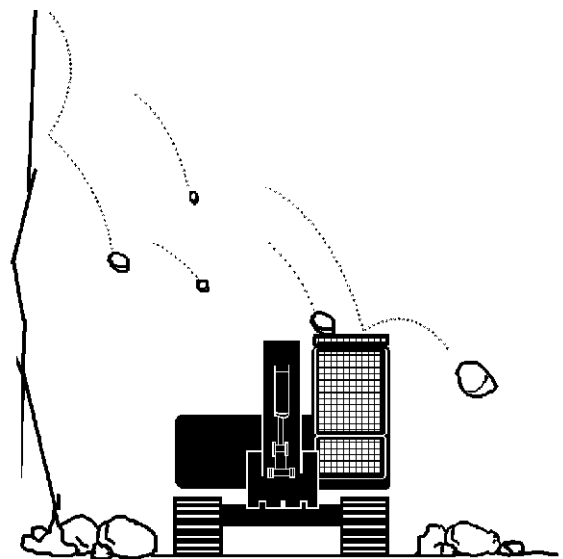

SA-490

015-E01A-0380

SAFETY

PROVIDE SIGNALS FOR JOBS INVOLVING MULTIPLE NUMBERS OF MACHINES

- For jobs involving multiple numbers of machines, provide signals commonly known by all personnel involved. Also, appoint a signal person to coordinate the job site. Make sure that all personnel obey the signal person's directions.



018-E01A-0481

SA-481

CONFIRM DIRECTION OF MACHINE TO BE DRIVEN

- Incorrect travel pedal/lever operation may result in serious injury death.
- Before driving the machine, confirm the position of the undercarriage in relation to the operator's position. If the travel motors are located in front of the cab, the machine will move in reverse when travel pedals/levers are operated to the front.

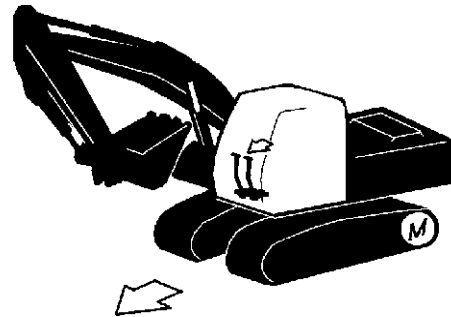

017-E01A-0491

SA-491

SAFETY

DRIVE MACHINE SAFELY

- Before driving the machine, always confirm that the travel levers/pedals direction corresponds to the direction you wish to drive.
- Be sure to detour around any obstructions.
- Avoid traveling over obstructions. Soil, fragments of rocks, and/or metal pieces may scatter around the machine. Don't allow personnel to stay around the machine while traveling.
- Driving on a slope may cause the machine to slip or overturn, possibly resulting in serious injury or death.
 - When driving up or down a slope, keep the bucket facing the direction of travel, approximately 0.5 to 1.0 m (A) above the ground.
 - If the machine starts to skid or becomes unstable, immediately lower the bucket to the ground and stop.

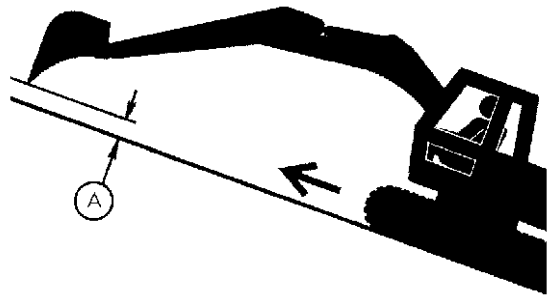

SA-387

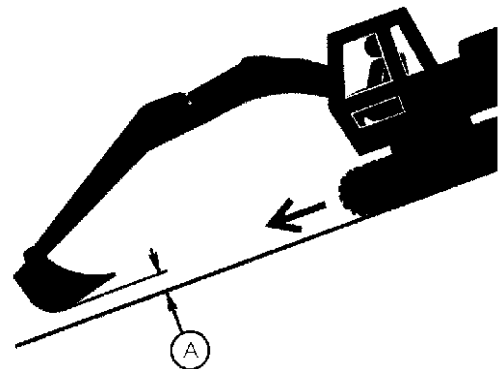

SA-388

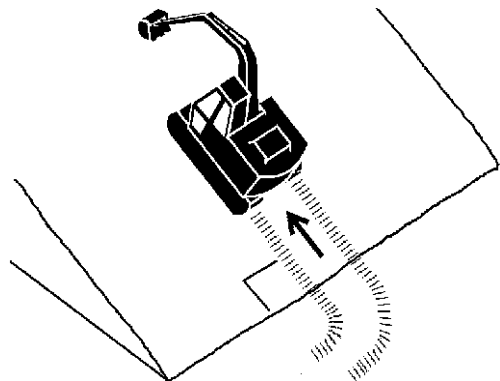

SA-441

- Driving across the face of a slope or steering on a slope may cause the machine to skid or turnover. If the direction must be changed, move the machine to level ground, then, change the direction to ensure safe operation.

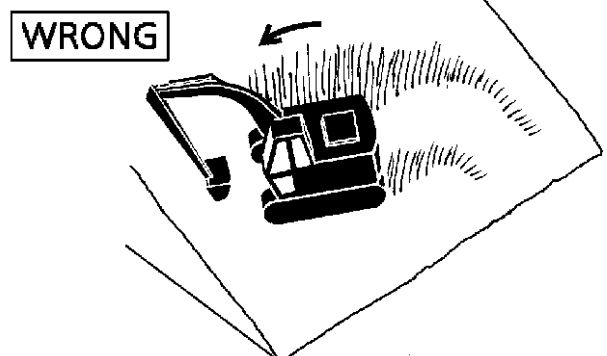

SA-589

019-E01C-0492

SAFETY

AVOID INJURY FROM ROLLAWAY ACCIDENTS

- Death or serious injury may result if you attempt to mount or stop a moving machine.

To avoid rollaways:

- Select level ground when possible to park machine.
- Do not park the machine on a grade.
- Lower the bucket and/or other work tools to the ground.
- Turn the auto-idle switch and the H/P mode switch off.
- Run the engine at slow idle speed without load for 5 minutes to cool down the engine.
- Stop the engine and remove the key from the key switch.
- Pull the pilot control shut-off lever to LOCK position.
- Block both tracks and lower the bucket to the ground. Thrust the bucket teeth into the ground if you must park on a grade.
- Position the machine to prevent rolling.
- Park a reasonable distance from other machines.

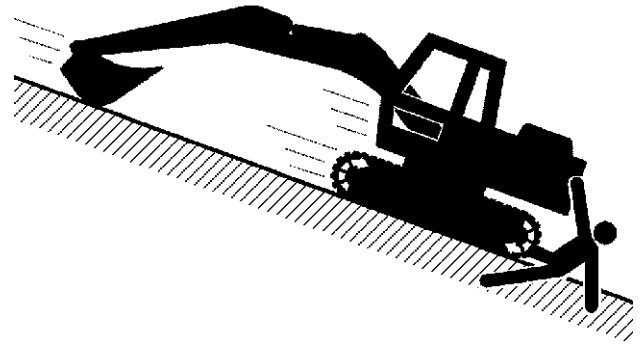

SA-391

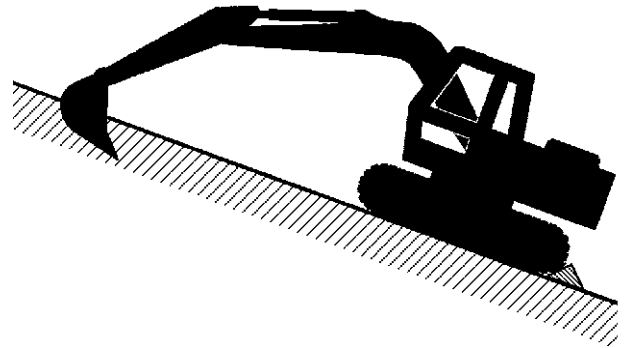

SA-392

020-E02A-0493

SAFETY

AVOID INJURY FROM BACK-OVER AND SWING ACCIDENTS

- If any person is present near the machine when backing or swinging the upperstructure, the machine may hit or run over that person, resulting in serious injury or death.

To avoid back-over and swing accidents:

- Always look around **BEFORE YOU BACK UP AND SWING THE MACHINE**. BE SURE THAT ALL BYSTANDERS ARE CLEAR.
- Keep the travel alarm in working condition (if equipped).
ALWAYS BE ALERT FOR BYSTANDERS MOVING INTO THE WORK AREA. USE THE HORN OR OTHER SIGNAL TO WARN BYSTANDERS BEFORE MOVING MACHINE.
- USE A SIGNAL PERSON WHEN BACKING UP IF YOUR VIEW IS OBSTRUCTED. ALWAYS KEEP THE SIGNAL PERSON IN VIEW.
Use hand signals, which conform to your local regulations, when work conditions require a signal person.
- No machine motions shall be made unless signals are clearly understood by both signalman and operator.
- Learn the meanings of all flags, signs, and markings used on the job and confirm who has the responsibility for signaling.
- Keep windows, mirrors, and lights clean and in good condition.
- Dust, heavy rain, fog, etc., can reduce visibility. As visibility decreases, reduce speed and use proper lighting.
- Read and understand all operating instructions in the operator's manual.

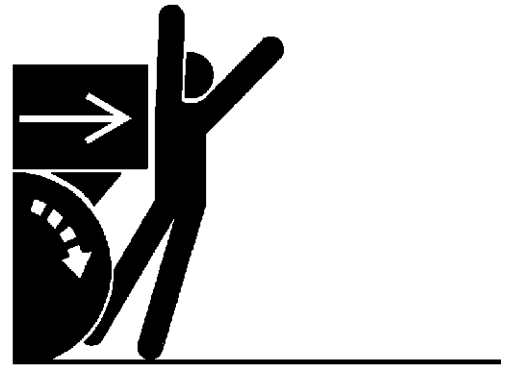

SA-383

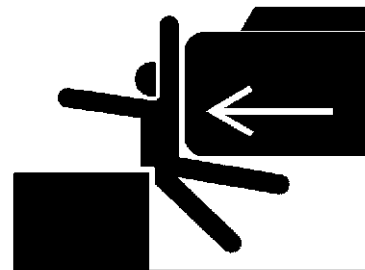

SA-384

021-E01A-0494

SAFETY

KEEP PERSON CLEAR FROM WORKING AREA

- A person may be hit severely by the swinging front attachment or counterweight and/or may be crushed against an other object, resulting in serious injury or death.
- Keep all persons clear from the area of operation and machine movement.
- Before operating the machine, set up barriers to the sides and rear area of the bucket swing radius to prevent anyone from entering the work area.

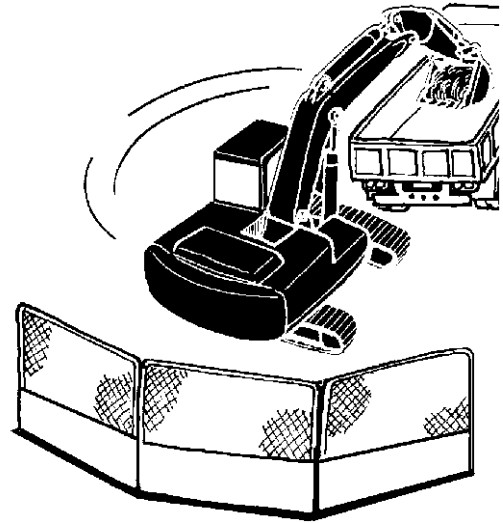

022-E01A-0386

SA-386

NEVER POSITION BUCKET OVER ANYONE

- Never lift, move, or swing bucket above anyone or a truck cab. Serious injury or machine damage may result due to bucket load spill or due to collision with the bucket.



023-E01A-0487

SA-487

AVOID UNDERCUTTING

- In order to retreat from the edge of an excavation if the footing should collapse, always position the undercarriage perpendicular to the edge of the excavation with the travel motors at the rear.
- If the footing starts to collapse and if retreat is not possible, do not panic. Often, the machine can be secured by lowering the front attachment, in such cases.

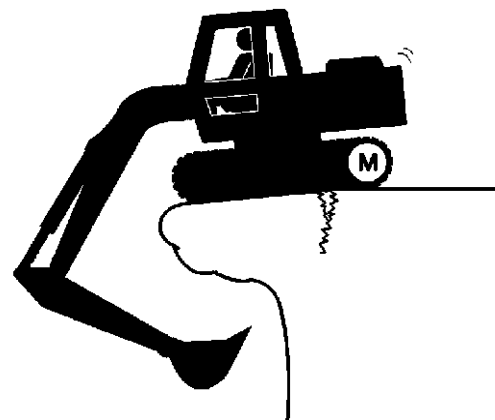

024-E01A-0488

SA-488

SAFETY

AVOID TIPPING

DO NOT ATTEMPT TO JUMP CLEAR OF TIPPING MACHINE --- SERIOUS OR FATAL CRUSHING INJURIES WILL RESULT

MACHINE WILL TIP OVER FASTER THAN YOU CAN JUMP FREE

FASTEN YOUR SEAT BELT

- The danger of tipping is always present when operating on a grade, possibly resulting in serious injury or death.

To avoid tipping:

- Be extra careful before operating on a grade.
 - Prepare machine operating area flat.
 - Keep the bucket low to the ground and close to the machine.
 - Reduce operating speeds to avoid tipping or slipping.
 - Avoid changing direction when traveling on grades.
 - NEVER attempt to travel across a grade steeper than 15 degrees if crossing the grade is unavoidable.
 - Reduce swing speed as necessary when swinging loads.
- Be careful when working on frozen ground.
 - Temperature increases will cause the ground to become soft and make ground travel unstable.

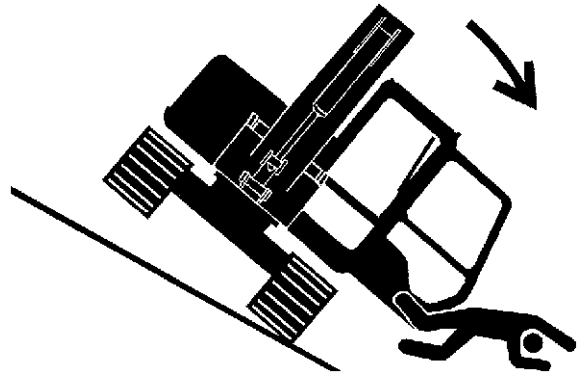

SA-012

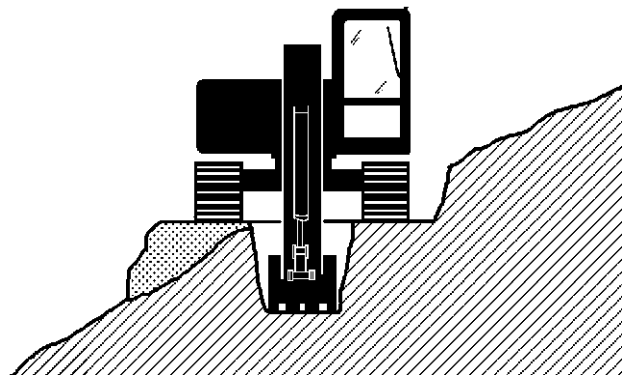

SA-440

025-E01B-0495

NEVER UNDERCUT A HIGH BANK

- The edges could collapse or a land slide could occur causing serious injury or death.



SA-489

026-E01A-0489

SAFETY

DIG WITH CAUTION

- Accidental severing of underground cables or gas lines may cause an explosion and/or fire, possibly resulting in serious injury or death.
 - Before digging check the location of cables, gas lines, and water lines.
 - Keep the minimum distance required, by law, from cables, gas lines, and water lines.
 - If a fiber optic cable should be accidentally severed, do not look into the end. Doing so may result in serious eye injury.
 - Contact your local “diggers hot line” if available in your area, and/or the utility companies directly. Have them mark all underground utilities.

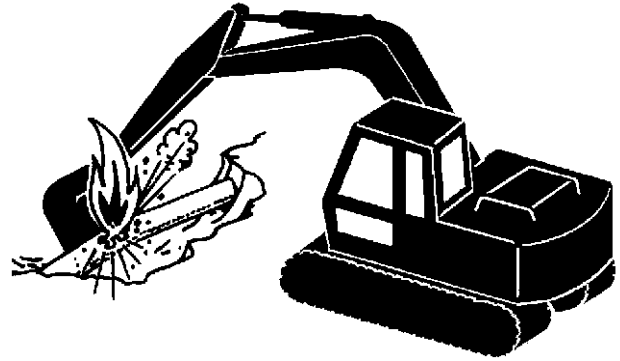

SA-382

027-E01A-0382

OPERATE WITH CAUTION

- If the front attachment or any other part of the machine hits against an overhead obstacle, such as a bridge, both the machine and the overhead obstacle will be damaged, and personal injury may result as well.
 - Take care to avoid hitting overhead obstacles with the boom or arm.

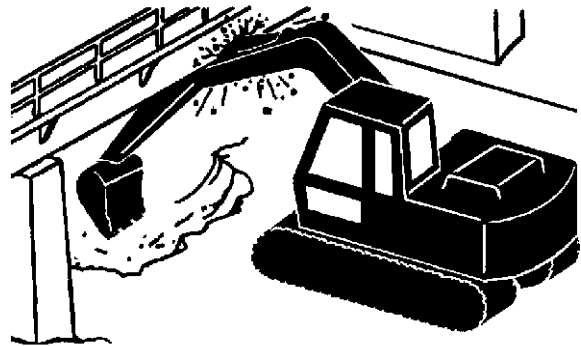

SA-389

028-E01A-0389

AVOID POWER LINES

- Serious injury or death can result if the machine or front attachments are not kept a safe distance from electric lines.
 - When operating near an electric line, NEVER move any part of the machine or load closer than 3 m plus twice the line insulator length.
 - Check and comply with any local regulations that may apply.
 - Wet ground will expand the area that could cause any person on it to be affected by electric shock. Keep all bystanders or co-workers away from the site.

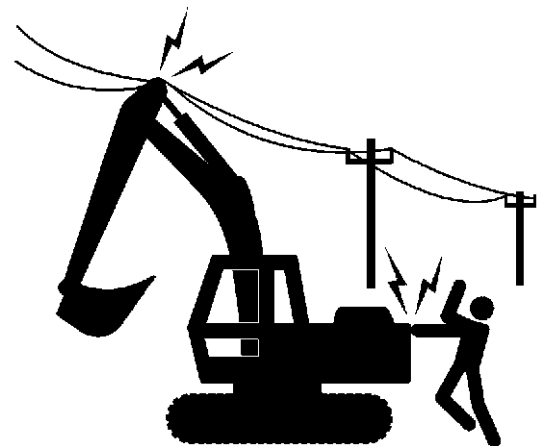

SA-381

029-E01A-0381

SAFETY

OBJECT HANDLING

- If a lifted load should fall, any person nearby may be struck by the falling load or may be crushed underneath it, resulting in serious injury or death.
- When using the machine for craning operations, be sure to comply with all local regulations.
- Do not use damaged chains or frayed cables, cables, slings, or ropes.
- Before craning, position the upperstructure with the travel motors at the rear.
- Move the load slowly and carefully. Never move it suddenly.
- Keep all persons away from the load.
- Never move a load over a person's head.
- Do not allow anyone to approach the load until it is safely and securely situated on supporting blocks or on the ground.
- Never attach a sling or chain to the bucket teeth. They may come off, causing the load to fall.

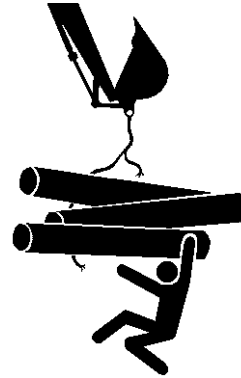

SA-014

030-E01A-0014

PROTECT AGAINST FLYING DEBRIS

- If flying debris hit eyes or any other part of the body, serious injury may result.
- Guard against injury from flying pieces of metal or debris; wear goggles or safety glasses.
- Keep bystanders away from the working area before striking any object.

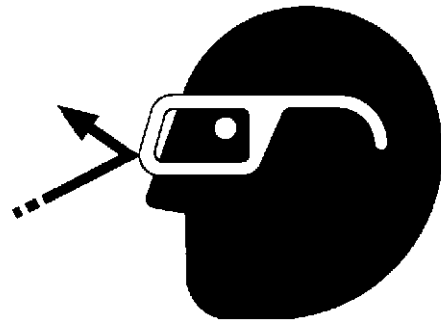

031-E01A-0432

SA-432

Thank you so much for reading.
Please click the “Buy Now!”
button below to download the
complete manual.



After you pay.

You can download the most
perfect and complete manual in
the world immediately.

Our support email:

ebooklibonline@outlook.com