

# OPERATOR'S MANUAL

## Excavator

Part No. EMCBB-EN2-1

### **ZX 130W**

Serial No. 001001 and up

### **ZX 160W**

Serial No. 002001 and up

### **ZX 180W**

Serial No. 001001 and up

### **ZX 210W**

Serial No. 001001 and up



HITACHI

# CONTENTS

---

## MACHINE NUMBERS

### SAFETY

Recognize Safety Information .....	S-1
Understand Signal Words .....	S-1
Follow Safety Instructions .....	S-2
Prepare for Emergencies .....	S-2
Wear Protective Clothing .....	S-3
Protect Against Noise .....	S-3
Inspect Machine .....	S-3
General Precautions for Cab .....	S-4
Use Handholds and Steps .....	S-5
Adjust the Operator's Seat .....	S-5
Fasten Your Seat Belt .....	S-6
Move and Operate Machine Safely .....	S-6
Handle Starting Aids Safely .....	S-6
Operate Only from Operator's Seat .....	S-7
Jump Starting .....	S-7
Keep Riders Off Machine .....	S-7
Investigate Job Site Beforehand .....	S-8
Protect Against Falling Stones and Debris .....	S-8
Provide Signals for Jobs Involving Multiple Numbers of Machines .....	S-9
Confirm Direction of Machine to be Driven .....	S-9
Drive Machine Safely (Work Site) .....	S-10
Avoid Injury from Rollaway Accidents .....	S-11
Avoid Injury from Back-Over and Swing Accidents .....	S-12
Keep Personnel Clear from Working Area .....	S-13
Never Position Bucket Over Anyone .....	S-13
Avoid Undercutting .....	S-13
Avoid Tipping .....	S-14
Never Undercut a High Bank .....	S-14
Dig with Caution .....	S-15
Operate with Caution .....	S-15
Avoid Power Lines .....	S-15
Object Handling .....	S-16
Protect Against Flying Debris .....	S-16
Park Machine Safely .....	S-17
Handle Fluids Safely – Avoid Fires .....	S-17
Safety Transporting .....	S-18
Practice Safe Maintenance .....	S-19
Warn Others of Service Work .....	S-20
Support Machine Properly .....	S-20
Stay Clear of Moving Parts .....	S-20
Prevent Parts from Flying .....	S-21
Store Attachments Safely .....	S-21
Support Maintenance Properly .....	S-21
Prevent Burns .....	S-22
Replace Rubber Hoses Periodically .....	S-22
Avoid High-Pressure Fluids .....	S-23
Prevent Fires .....	S-24
Evacuating in Case of Fire .....	S-25
Beware of Exhaust Fumes .....	S-25
Precautions for Welding and Grinding .....	S-26
Avoid Heating Near Pressurized Fluid Lines .....	S-27

Avoid Applying Heat to Lines Containing Flammable Fluids .....	S-27
Remove Paint Before Welding or Heating .....	S-27
Prevent Battery Explosions .....	S-28
Service Air Conditioning System Safely .....	S-28
Handle Chemical Products Safely .....	S-29
Dispose of Waste Properly .....	S-29

### SAFETY SIGNS .....

### COMPONENTS NAME .....

### OPERATOR'S STATION

Cab Features .....	1-2
Steering Column Console .....	1-3
Steering Wheel and Horn Switch .....	1-4
Forward/Reverse Travel Pedal .....	1-4
Brake Pedal .....	1-5
Brake Oil Pressure Gauge and Indicator .....	1-6
Sift Lever .....	1-7
Combination Switch With Turn Signal Switch, Light and Dimmer Switches .....	1-8
Brake Switch .....	1-9
Hazard Light Switch .....	1-10
Abnormal Travel Motor Indicator .....	1-10
Wiper Switch .....	1-11
Speedometer .....	1-11
Monitor Panel .....	1-12
Coolant Temperature Gauge .....	1-13
Fuel Gauge .....	1-13
Auto-Idle Indicator .....	1-13
Auto-Acceleration Indicator .....	1-13
Fuel Level Indicator .....	1-14
Air Filter Restriction Indicator .....	1-14
Overheat Indicator .....	1-14
Engine Oil Pressure Indicator .....	1-14
Alternator Indicator .....	1-15
Preheat Indicator .....	1-15
Hydraulic Oil Filter Restriction Indicator (If equipped) .....	1-15
Overload Alarm Indicator (Optional) .....	1-15
Liquid Crystal Display (LCD), Display Selection Switch, Set Switch .....	1-16
Hour Meter .....	1-16
Trip Meter (Trip Meter 1 and Trip Meter 2) ....	1-17
Engine Speed .....	1-17
Hydraulic Oil Temperature .....	1-17
Trip Meter Function .....	1-18
Work Mode Switch .....	1-20
Switch Panel .....	1-21
Engine Control Dial .....	1-21
Engine Control Mode Selection Switch .....	1-22
Work Light Switch .....	1-23
Power Mode Switch .....	1-24
Auto-Idle/Acceleration Selector .....	1-24
Switch Panel (Optional) .....	1-25

---

# CONTENTS

---

Key Switch.....	1-26
Power Boost Switch.....	1-26
Attachment Switch (When Optional Attachment is Equipped).....	1-26
Horn Switch.....	1-27
Attachment Selection Switch (When the 2-piece Boom and an Optional Attachment are Installed).....	1-27
Cigar Lighter.....	1-28
12-V Power Source (Optional).....	1-29
Cab Light.....	1-30
Installing Fire Extinguisher.....	1-30
First Aid Kit.....	1-30
Pilot Control Shut-Off Lever.....	1-31
Engine Stop Knob.....	1-31
Swing Lock Lever.....	1-32
Fuse Box.....	1-33
Auto Air Conditioner.....	1-34
Cab Heater Operation.....	1-37
Cooling Operation.....	1-38
Defroster Operation.....	1-38
Tips for Optimal Air Conditioner Usage.....	1-39
Auto Air Conditioner.....	1-40
Cab Heater Operation.....	1-44
Cooling Operation.....	1-45
Defroster Operation.....	1-45
Tips for Optimal Air Conditioner Usage.....	1-47
Cab Heater (Optional).....	1-48
Cab Heater Operation.....	1-49
Defroster Operation.....	1-50
AM/FM Radio Operation.....	1-51
Digital Clock Setting Procedure.....	1-52
Cab Door Release Lever.....	1-53
Opening Upper Front Window.....	1-53
Closing Upper Front Window.....	1-54
Removing and Storing Lower Front Window.....	1-55
Opening Side Windows.....	1-55
Opening/Closing Overhead Window.....	1-56
Emergency Exit.....	1-57
Adjusting the Seat.....	1-58
Seat with a Built-In Heater (Optional).....	1-59
Adjusting the Air-Suspension Seat (Optional).....	1-60
Seat with a Built-In Heater.....	1-61
Seat Belt.....	1-62

## BREAK-IN

Observe Engine Operation Closely.....	2-1
Every 8 Hours or Daily.....	2-1
After the First 50 Hours.....	2-1
After the First 100 Hours.....	2-1

## OPERATING THE ENGINE

Inspect Machine Daily Before Starting.....	3-1
Before Starting Engine.....	3-2
Starting The Engine in Ordinary Temperature.....	3-3
Starting in Cold Weather.....	3-4

Check Instruments After Starting.....	3-5
Using Booster Batteries.....	3-6
Stopping the Engine.....	3-8

## DRIVING THE MACHINE

Traveling.....	4-1
Engine Speed Control.....	4-5
Stopping and Restarting While Traveling on a Public Road.....	4-7
Instructions for Traveling on a Slope.....	4-9
Traveling in Water or on Soft Terrain.....	4-10
Extrication from Soft Ground.....	4-10
Parking.....	4-11
Emergency Parking.....	4-12

## OPERATING THE MACHINE

Control Lever (ISO Pattern).....	5-1
Pilot Control Shut-Off Lever.....	5-2
Steering Wheel Column.....	5-3
Engine Speed Control.....	5-6
Auto-Idle.....	5-7
Auto Acceleration.....	5-8
Work Mode.....	5-10
Power Boost.....	5-10
Power Mode.....	5-11
Engine Speed Control Mode Selection Switch.....	5-12
Precautions for Operations.....	5-13
Operate the Machine Safely.....	5-14
Traveling/Operating the Machine on a Slope.....	5-15
Parking/Stopping the Machine on a Slope (in Case of Emergency).....	5-16
Raising the Machine Front Using the Boom and Arm.....	5-16
Excavation.....	5-17
Face Shovel Operation.....	5-18
Avoid Excavation While Striking with the Bucket Teeth.....	5-18
Grading.....	5-19
Do Not Use The Bucket Instead of a Hammer.....	5-19
Avoid Increasing Digging Force Forcibly.....	5-20
Avoid Using Swing Power.....	5-20
Emergency Boom Lowering Procedure.....	5-21
Object Handling --- If Equipped.....	5-24
Overnight Storage Instructions.....	5-26

## TRANSPORTATION

General Transportation Hints.....	6-1
Loading/Unloading The Machine.....	6-2
Towing Machine.....	6-5
Machine Lifting Procedure.....	6-6

## MAINTENANCE

Correct Maintenance and Inspection Procedures.....	7-1
Check the Hour Meter Regularly.....	7-2
Use Correct Fuels and Lubricants.....	7-2
Layout.....	7-3

---

# CONTENTS

---

Maintenance Guide Table.....	7-4	Check and Adjust Fan Belt Tension .....	7-66
Prepare Machine for Maintenance.....	7-6	Change Coolant.....	7-67
Hood and Access Covers .....	7-7	Clean Radiator, Oil Cooler Core and Inter Cooler .....	7-68
Periodic Replacement of Parts .....	7-8	Clean Oil Cooler Front Screen .....	7-68
Maintenance Guide .....	7-9	Clean Air Conditioner Condenser.....	7-68
A. Greasing .....	7-15	J. Electrical System .....	7-69
Front Joint Pins .....	7-15	Batteries.....	7-69
Swing Bearing.....	7-18	Replace Batteries.....	7-72
Swing Internal Gear .....	7-19	Remove and Installing Battery.....	7-73
Front Axle.....	7-20	Replacing Fuses .....	7-73
Propel Shaft.....	7-21	K. Miscellaneous .....	7-75
Equalizer Pin .....	7-22	Check Bucket Teeth.....	7-75
B. Engine.....	7-23	Change Bucket .....	7-77
Engine Oil Level .....	7-23	Convert Bucket Connection Into Face Shovel .....	7-78
Change Engine Oil.....	7-24	Adjust the Bucket Linkage .....	7-79
Replace Engine Oil Filter.....	7-24	Check and Replace Seat Belt .....	7-80
C. Transmission .....	7-26	Check Windshield Washer Fluid Level.....	7-80
Pump Transmission.....	7-26	Clean and Replace Air Conditioner Filter Clean Filter .....	7-81
Swing Reduction Gear .....	7-27	Check the Air Conditioner.....	7-83
Transmission Gear Oil .....	7-28	Clean Cab Floor .....	7-84
Front Axle.....	7-29	Check Injection Nozzle .....	7-85
Rear Axle .....	7-30	Retighten Cylinder Head Bolt.....	7-85
Front and Rear Hub Reduction Devices.....	7-31	Inspect and Adjust Valve Clearance .....	7-85
D. Brake (Traveling).....	7-32	Check Fuel Injection Timing.....	7-85
Check Brake Accumulator.....	7-33	Measure Engine Compression Pressure .....	7-85
Check Wear on Brake Lining .....	7-34	Check Starter and Alternator .....	7-85
E. Tire .....	7-35	Change Water Pump Grease.....	7-85
Tire Inspection and Replacement Procedure.....	7-36	Check Tightening Torque of Bolts and Nuts .....	7-86
F. Hydraulic System.....	7-37	<b>HYDRAULIC CIRCUIT AND ELECTRICAL CIRCUIT</b>	
Inspection and Maintenance of Hydraulic Equipment.....	7-37	Hydraulic Circuit.....	8-1
Replacement of Hydraulic Oil and Filter .....	7-39	Electrical Circuit.....	8-2
Check Hydraulic Oil Level.....	7-40	Electrical Diagram.....	8-3
Drain Hydraulic Oil Tank Sump .....	7-41	<b>MAINTENANCE UNDER SPECIAL ENVIRONMENTAL CONDITIONS</b>	
Change Hydraulic Oil .....	7-42	Maintenance Under Special Environmental Conditions .....	9-1
Clean the Suction Filter.....	7-45	<b>STORAGE</b>	
Replace Hydraulic Tank Oil Filter (Std. Model) .....	7-46	Storing the Machine .....	10-1
Replace Full-Flow Filter (Optional).....	7-47	Removing the Machine from Storage .....	10-2
Replace Pilot Brake and Steering Filter.....	7-48	Installing Vandal-Proof Covers .....	10-3
Replace Air Breather Element.....	7-49	Help Prevent Crime.....	10-4
Clean Steering Suction Filter Element .....	7-50	Record Identification Numbers .....	10-4
Check Hoses and Lines .....	7-51	Keep Proof of Ownership.....	10-4
Service Recommendations for Hydraulic Fittings .....	7-54	Park Indoors Out of Sight .....	10-4
G. Fuel System .....	7-56	When Parking Outdoors.....	10-5
Drain Fuel Tank Sump .....	7-58	Reduce Vandalism .....	10-5
Check Water Separator.....	7-58	Report Thefts Immediately.....	10-5
Replace Fuel Filter .....	7-60		
Clean Feed Pump Strainer .....	7-61		
Check Fuel Hoses .....	7-62		
H. Air Cleaner.....	7-63		
Clean Air Cleaner Outer Element .....	7-63		
Replace Inner Element (Optional).....	7-64		
I. Cooling System.....	7-65		
Check Coolant Level .....	7-66		

---

# CONTENTS

---

## TROUBLESHOOTING

Troubleshooting..... 11-1

## SPECIFICATIONS

### ZAXIS130W

Specifications ..... 12-1

Working Ranges..... 12-6

### ZAXIS160W

Specifications ..... 12-8

Working Ranges..... 12-13

### ZAXIS180W

Specifications ..... 12-15

Working Ranges..... 12-20

### ZAXIS210W

Specifications ..... 12-22

Working Ranges..... 12-27

Sound level results (2000/14/EC)..... 12-29

## OPTIONAL ATTACHMENTS AND DEVICES

Blade and stabilizer..... 13-1

Maintenance..... 13-5

2-Piece Boom..... 13-6

Maintenance (2-Piece Boom) ..... 13-7

Specifications (ZAXIS130W)..... 13-10

Specifications (ZAXIS160W)..... 13-12

Specifications (ZAXIS180W)..... 13-21

Specifications (ZAXIS210W)..... 13-23

Lifting Capacities (ZAXIS130W)..... 13-28

Lifting Capacities (ZAXIS160W)..... 13-34

Lifting Capacities (ZAXIS180W)..... 13-46

Lifting Capacities (ZAXIS210W)..... 13-52

Attachment Pedal (Breaker)..... 13-68

Precautions for Breaker Operation ..... 13-69

Replacement of Hydraulic Oil and Filter..... 13-71

Attachment Pedal (Hydraulic Crusher)..... 13-72

Precautions for Crusher Operation ..... 13-73

Electronic Key Lock Operation Manual..... 13-74

Registration/Registration Cancellation of

Ordinary Operation Key..... 13-77

Additional Registration Procedure ..... 13-78

Registration Cancellation Procedure..... 13-79

**INDEX**..... 14-1

---

# SAFETY

## RECOGNIZE SAFETY INFORMATION

- These are the **SAFETY ALERT SYMBOLS**.
  - When you see these symbols on your machine or in this manual, be alert to the potential for personal injury.
  - Follow recommended precautions and safe operating practices.

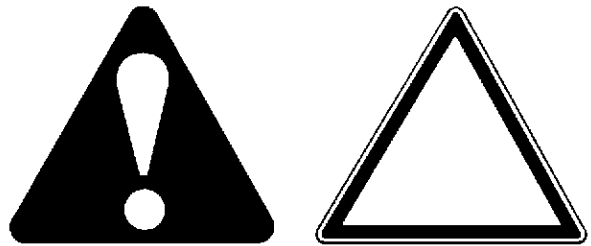

001-E01A-0001

SA-688

## UNDERSTAND SIGNAL WORDS

- On machine safety signs, signal words designating the degree or level of hazard - **DANGER**, **WARNING**, or **CAUTION** - are used with the safety alert symbol.
  - **DANGER** indicates an imminently hazardous situation which, if not avoided, will result in death or serious injury.
  - **WARNING** indicates a potentially hazardous situation which, if not avoided, could result in death or serious injury.
  - **CAUTION** indicates a potentially hazardous situation which, if not avoided, may result in minor or moderate injury.
  - **DANGER** or **WARNING** safety signs are located near specific hazards. General precautions are listed on **CAUTION** safety signs.
  - Some safety signs don't use any of the designated signal words above after the safety alert symbol are occasionally used on this machine.



**IMPORTANT**



- **CAUTION** also calls attention to safety messages in this manual.
- To avoid confusing machine protection with personal safety messages, a signal word **IMPORTANT** indicates a situation which, if not avoided, could result in damage to the machine.
-  **NOTE** indicates an additional explanation for an element of information.

002-E01A-1223

SA-1223

# SAFETY

## FOLLOW SAFETY INSTRUCTIONS

- Carefully read and follow all safety signs on the machine and all safety messages in this manual.
- Safety signs should be installed, maintained and replaced when necessary.
  - If a safety sign or this manual is damaged or missing, order a replacement from your authorized dealer in the same way you order other replacement parts (be sure to state machine model and serial number when ordering).
- Learn how to operate the machine and its controls correctly and safely.
- Allow only trained, qualified, authorized personnel to operate the machine.
- Keep your machine in proper working condition.
  - Unauthorized modifications of the machine may impair its function and/or safety and affect machine life.
- The safety messages in this SAFETY chapter are intended to illustrate basic safety procedures of machines. However it is impossible for these safety messages to cover every hazardous situation you may encounter. If you have any questions, you should first consult your supervisor and/or your authorized dealer before operating or performing maintenance work on the machine.

003-E01B-0003

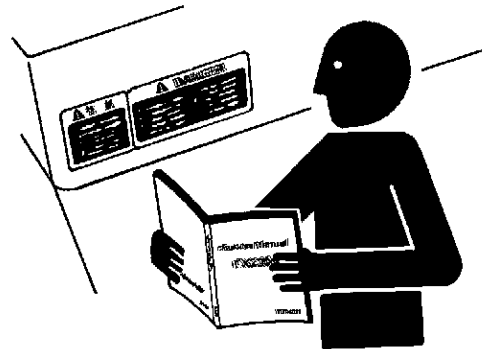

SA-003

## PREPARE FOR EMERGENCIES

- Be prepared if a fire starts or if an accident occurs.
  - Keep a first aid kit and fire extinguisher on hand.
  - Thoroughly read and understand the label attached on the fire extinguisher to use it properly.
  - To ensure that a fire-extinguisher can be always used when necessary, check and service the fire-extinguisher at the recommended intervals as specified in the fire-extinguisher manual.
- Establish emergency procedure guidelines to cope with fires and accidents.
- Keep emergency numbers for doctors, ambulance service, hospital, and fire department posted near your telephone.

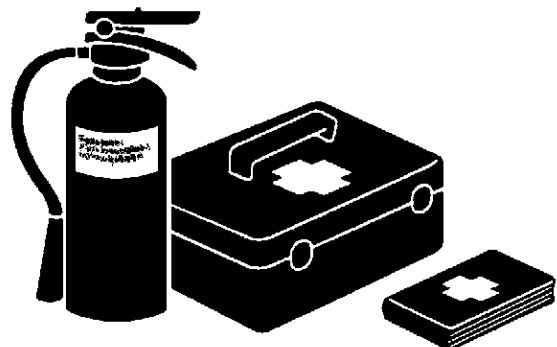

SA-437

004-E01A-0437

# SAFETY

## WEAR PROTECTIVE CLOTHING

- Wear close fitting clothing and safety equipment appropriate to the job.

You may need:

- A hard hat
- Safety shoes
- Safety glasses, goggles, or face shield
- Heavy gloves
- Hearing protection
- Reflective clothing
- Wet weather gear
- Respirator or filter mask.

Be sure to wear the correct equipment and clothing for the job. Do not take any chances.

- Avoid wearing loose clothing, jewelry, or other items that can catch on control levers or other parts of the machine.
- Operating equipment safely requires the full attention of the operator. Do not wear radio or music headphones while operating the machine.

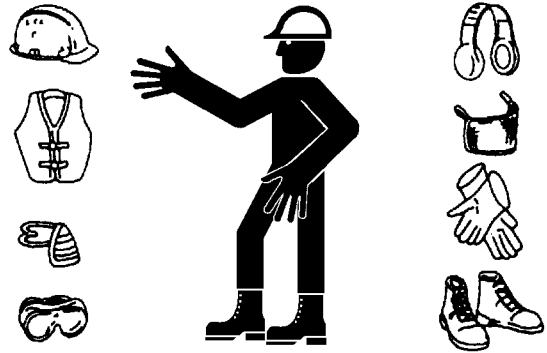

SA-438

005-E01A-0438

## PROTECT AGAINST NOISE

- Prolonged exposure to loud noise can cause impairment or loss of hearing.
- Wear a suitable hearing protective device such as earmuffs or earplugs to protect against objectionable or uncomfortably loud noises.



006-E01A-0434

SA-434

## INSPECT MACHINE

- Inspect your machine carefully each day or shift by walking around it before you start it to avoid personal injury.
- In the walk-around inspection, be sure to cover all points described in the "PRE-START INSPECTION" chapter in the operator's manual.



007-E01A-0435

SA-435



# SAFETY

---

## GENERAL PRECAUTIONS FOR CAB

- Before entering the cab, thoroughly remove all dirt and/or oil from the soles of your work boots. If any controls such as a pedal is operated while with dirt and/or oil on the soles of the operator's work boots the operator's foot may slip off the pedal, possibly resulting in a personal accident.
- Don't leave parts and/or tools lying around the operator's seat. Store them in their specified locations.
- Avoid storing transparent bottles in the cab. Don't attach any transparent type window decorations on the windowpanes as they may focus sunlight, possibly starting a fire.
- Refrain from listening to the radio, or using music headphones or mobile telephones in the cab while operating the machine.
- Keep all flammable objects and/or explosives away from the machine.
- After using the ashtray, always cover it to extinguish the match and/or tobacco.
- Don't leave cigarette lighters in the cab. When the temperature in the cab increases, the lighter may explode.

524-E01A-0000

## SAFETY

---

### USE HANDHOLDS AND STEPS

- Falling is one of the major causes of personal injury.
  - When you get on and off the machine, always face the machine and maintain a three-point contact with the steps and handrails.
  - Do not use any controls as handholds.
  - Never jump on or off the machine. Never mount or dismount a moving machine.
  - Be careful of slippery conditions on platforms, steps, and handrails when leaving the machine.

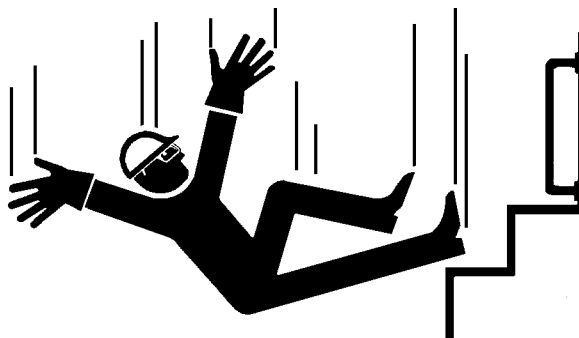

SA-439

008-E01A-0439

### ADJUST THE OPERATOR'S SEAT

- A poorly adjusted seat for either the operator or for the work at hand may quickly fatigue the operator leading to misoperations.
  - The seat should be adjusted whenever changing the operator for the machine.
  - The operator should be able to fully depress the pedals and to correctly operate the control levers with his back against the seat back.
  - If not, move the seat forward or backward, and check again.



SA-378

009-E01A-0378

# SAFETY

## FASTEN YOUR SEAT BELT

- If the machine should overturn, the operator may become injured and/or thrown from the cab. Additionally the operator may be crushed by the overturning machine, resulting in serious injury or death.
- Prior to operating the machine, thoroughly examine webbing, buckle and attaching hardware. If any item is damaged or worn, replace the seat belt or component before operating the machine.
- Be sure to remain seated with the seat belt securely fastened at all times when the machine is in operation to minimize the chance of injury from an accident.
- We recommend that the seat belt be replaced every three years regardless of its apparent condition.

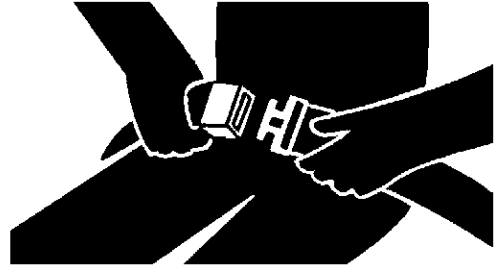

SA-237

010-E01A-0237

## MOVE AND OPERATE MACHINE SAFELY

- Bystanders can be run over.
- Take extra care not to run over bystanders. Confirm the location of bystanders before moving, swinging, or operating the machine.
- Always keep the travel alarm and horn in working condition (if equipped). It warns people when the machine starts to move.
- Use a signal person when moving, swinging, or operating the machine in congested areas. Coordinate hand signals before starting the machine.

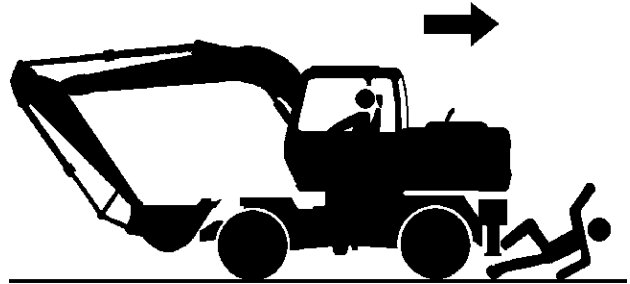

SA-083

011-E01A-0426

## HANDLE STARTING AIDS SAFELY

Starting fluid:

- Starting fluid is highly flammable.
- Keep all sparks and flame away when using it.
- Keep starting fluid well away from batteries and cables.
- Remove container from machine if engine does not need starting fluid.
- To prevent accidental discharge when storing a pressurized container, keep the cap on the container, and store it in a cool, well-protected location.
- Do not incinerate or puncture a starting fluid container.



SA-293

036-E01A-0293-3

# SAFETY

## OPERATE ONLY FROM OPERATOR'S SEAT

- Inappropriate engine starting procedures may cause the machine to runaway, possibly resulting in serious injury or death.
  - Start the engine only from the operator's seat.
  - NEVER start the engine while standing on the tire or on ground.
  - Do not start engine by shorting across starter terminals.
  - Before starting the engine, confirm that all control levers are in neutral.

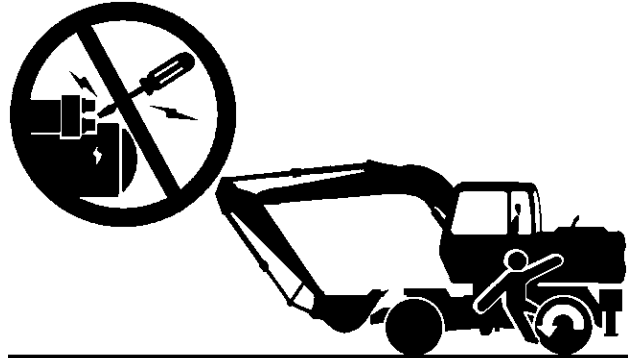

SA-084

012-E01B-0444

## JUMP STARTING

- Battery gas can explode, resulting in serious injury.
  - If the engine must be jump started, be sure to follow the instructions shown in the "OPERATING THE ENGINE" chapter.
  - The operator must be in the operator's seat so that the machine will be under control when the engine starts. Jump starting is a two-person operation.
  - Never use a frozen battery.
  - Failure to follow correct jump starting procedures could result in a battery explosion or a runaway machine.

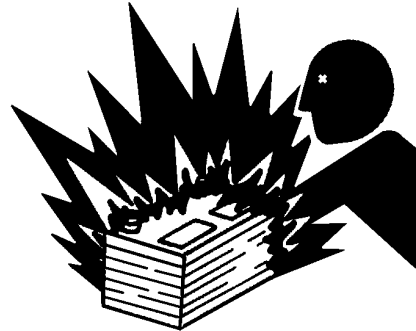

SA-032

S013-E01A-0032

## KEEP RIDERS OFF MACHINE

- Riders on machine are subject to injury such as being struck by foreign objects and being thrown off the machine.
  - Only allow the operator on the machine. Keep riders off.
  - Riders also obstruct the operator's view, resulting in the machine being operated in an unsafe manner.



SA-091

014-E01B-0379

4

# SAFETY

## INVESTIGATE JOB SITE BEFOREHAND

- When working at the edge of an excavation or on a road shoulder, the machine could tip over, possibly resulting in serious injury or death.
- Investigate the configuration and ground conditions of the job site beforehand to prevent the machine from falling and to prevent the ground, stockpiles, or banks from collapsing.
- Make a work plan. Use machines appropriate to the work and job site.
- Reinforce ground, edges, and road shoulders as necessary. Keep the machine well back from the edges of excavations and road shoulders.
- When working on an incline or on a road shoulder, employ a signal person as required.
- Confirm that your machine is equipped a FOPS cab before working in areas where the possibility of falling stones or debris exist.
- When the footing is weak, reinforce the ground before starting work.
- When working on frozen ground, be extremely alert. As ambient temperatures rise, footing becomes loose and slippery.
- Beware the possibility of fire when operating the machine near flammable objects such as dry grass.



SA-085

015-E01A-0380

## PROTECT AGAINST FALLING STONES AND DEBRIS

- Confirm that your machine is FOPS cab equipped before working in areas where the possibility of falling stones or debris exist.

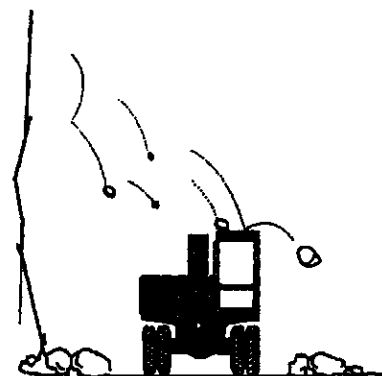

SA-686

015-E01A-0380

## SAFETY

---

### PROVIDE SIGNALS FOR JOBS INVOLVING MULTIPLE NUMBERS OF MACHINES

- For jobs involving multiple numbers of machines, provide signals commonly known by all personnel involved. Also, appoint a signal person to coordinate the job site. Make sure that all personnel obey the signal person's directions.



018-E01A-0481

SA-481

### CONFIRM DIRECTION OF MACHINE TO BE DRIVEN

- Incorrect steering wheel/forward/reverse pedal operation may result in serious injury or death.
- Before driving the machine, confirm the position of the undercarriage in relation to the operator's position. If the travel motors are located in front of the cab, the machine will move in reverse when steering wheel is operated to the front.



017-E02B-0092

SA-092

## SAFETY

### DRIVE MACHINE SAFELY (WORK SITE)

- Before driving the machine, always confirm that the steering wheel/forward/reverse pedal direction corresponds to the direction you wish to drive.
  - Be sure to detour around any obstructions.
- Driving on a slope may cause the machine to slip or overturn, possibly resulting in serious injury or death.
  - When driving up or down a slope, keep the bucket facing the direction of travel, approximately 0.5 to 1.0 m (A) above the ground.
  - If the machine starts to skid or becomes unstable, immediately lower the bucket to the ground and stop.
- Driving across the face of a slope or steering on a slope may cause the machine to skid or overturn. If the direction must be changed, move the machine to level ground, then, change the direction to ensure safe operation.

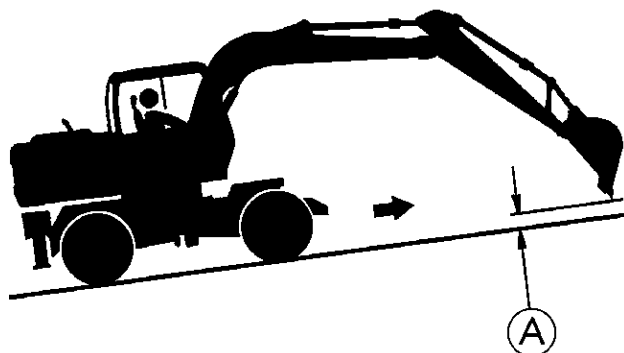

SA-090

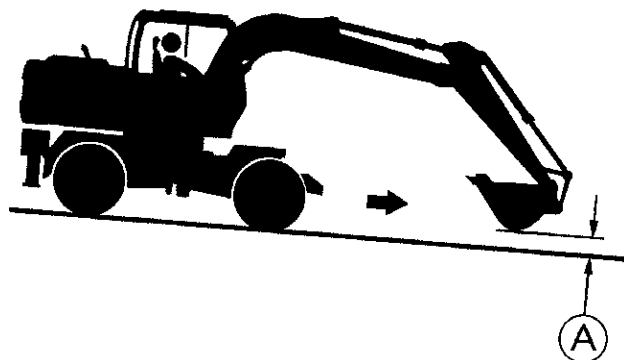

SA-288

019-E05B-0090

## SAFETY

### AVOID INJURY FROM ROLLAWAY ACCIDENTS

- Death or serious injury may result if you attempt to mount or stop a moving machine.

To avoid rollaways:

- Select level ground when possible to park machine.
- Do not park the machine on a grade.
- Lower the bucket and/or other work tools to the ground.
- Place the shift lever in neutral, and put the brake switch in the P (parking brake) position.
- Turn the auto-idle switch off.
- Run the engine at slow idle speed without load for 5 minutes to cool down the engine.
- Stop the engine and remove the key from the key switch.
- Pull the pilot control shut-off lever to LOCK position.
- Block both tires and lower the bucket to the ground. Thrust the bucket teeth into the ground if you must park on a grade.
- Position the machine to prevent rolling.
- Park a reasonable distance from other machines.

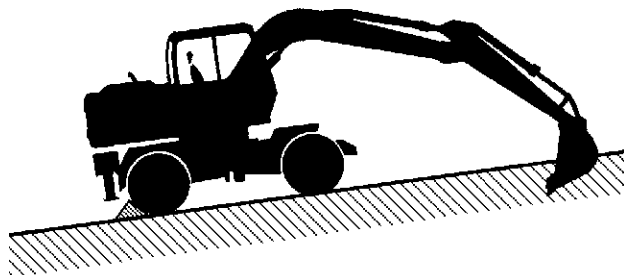
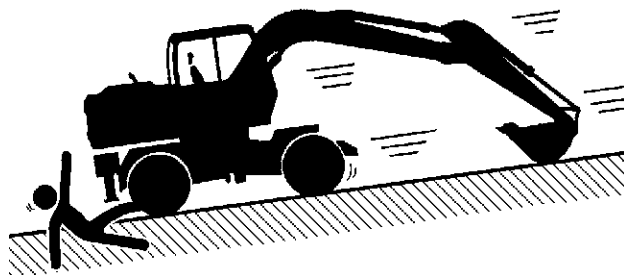

SA-278

020-E01A-0270



## SAFETY

### AVOID INJURY FROM BACK-OVER AND SWING ACCIDENTS

- If any person is present near the machine when backing or swinging the upperstructure, the machine may hit or run over that person, resulting in serious injury or death.

To avoid back-over and swing accidents:

- Always look around **BEFORE YOU BACK UP AND SWING THE MACHINE. BE SURE THAT ALL BY-STANDERS ARE CLEAR.**
- Keep the travel alarm in working condition (if equipped).  
**ALWAYS BE ALERT FOR BYSTANDERS MOVING INTO THE WORK AREA. USE THE HORN OR OTHER SIGNAL TO WARN BYSTANDERS BEFORE MOVING MACHINE.**
- **USE A SIGNAL PERSON WHEN BACKING UP IF YOUR VIEW IS OBSTRUCTED. ALWAYS KEEP THE SIGNAL PERSON IN VIEW.**  
Use hand signals, which conform to your local regulations, when work conditions require a signal person.
- No machine motions shall be made unless signals are clearly understood by both signalman and operator.
- Learn the meanings of all flags, signs, and markings used on the job and confirm who has the responsibility for signaling.
- Keep windows, mirrors, and lights clean and in good condition.
- Dust, heavy rain, fog, etc., can reduce visibility. As visibility decreases, reduce speed and use proper lighting.
- Read and understand all operating instructions in the operator's manual.

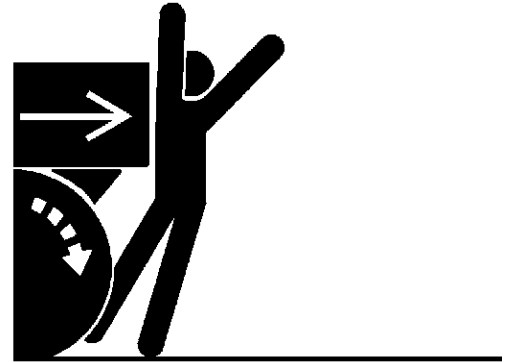

SA-383

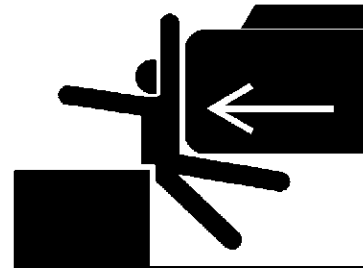

SA-384

021-E01A-0494

## SAFETY

### KEEP PERSONNEL CLEAR FROM WORKING AREA

- A person may be hit severely by the swinging front attachment or counterweight and/or may be crushed against an other object, resulting in serious injury or death.
- Keep all persons clear from the area of operation and machine movement.
- Before operating the machine, set up barriers to the sides and rear area of the bucket swing radius to prevent anyone from entering the work area.

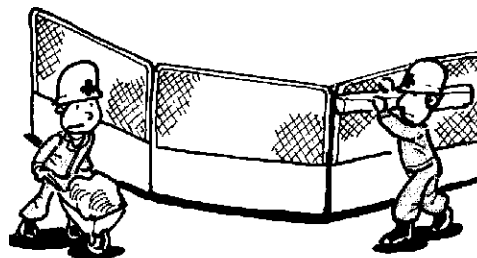
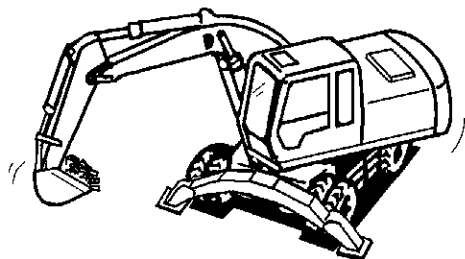

022-E01A-M202-05-014

M202-05-014

### NEVER POSITION BUCKET OVER ANYONE

- Never lift, move, or swing bucket above anyone or a truck cab. Serious injury or machine damage may result due to bucket load spill or due to collision with the bucket.



023-E01A-0682

SA-682

### AVOID UNDERCUTTING

- Always confirm that ground conditions are strong enough to support the machine weight when operating near a cliff. Operate the machine with the chassis frame positioned perpendicular to the cliff face so that the machine can more easily evacuate if the cliff face collapses.
- If the footing starts to collapse and if the sufficient retreat is not possible, do not panic. Often, the machine can be secured by lowering the front attachment, in such cases.

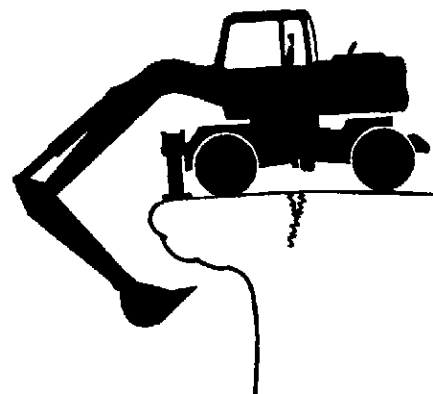

024-E01A-0683

SA-683

# SAFETY

## AVOID TIPPING

**DO NOT ATTEMPT TO JUMP CLEAR OF TIPPING MACHINE---SERIOUS OR FATAL CRUSHING INJURIES WILL RESULT**

**MACHINE WILL TIP OVER FASTER THAN YOU CAN JUMP FREE**

**FASTEN YOUR SEAT BELT**

- The danger of tipping is always present when operating on a grade, possibly resulting in serious injury or death.

To avoid tipping:

- Be extra careful before operating on a grade.
  - Prepare machine operating area flat.
  - Keep the bucket low to the ground and close to the machine.
  - Reduce operating speeds to avoid tipping or slipping.
  - Avoid changing direction when traveling on grades.
  - NEVER attempt to travel across a grade steeper than 5 degrees if crossing the grade is unavoidable.
  - Reduce swing speed as necessary when swinging loads.
- Be careful when working on frozen ground.
  - Temperature increases will cause the ground to become soft and make ground travel unstable.

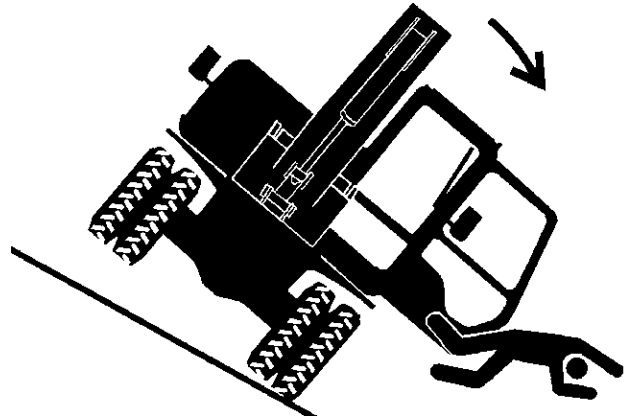

SA-012

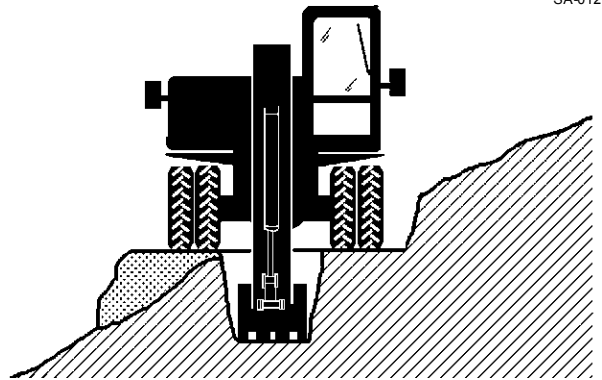

SA-562

025-E03B-0569

## NEVER UNDERCUT A HIGH BANK

- The edges could collapse or a land slide could occur causing serious injury or death.



026-E01A-0685

SA-685

# SAFETY

## DIG WITH CAUTION

- Accidental severing of underground cables or gas lines may cause an explosion and/or fire, possibly resulting in serious injury or death.
  - Before digging check the location of cables, gas lines, and water lines.
  - Keep the minimum distance required, by law, from cables, gas lines, and water lines.
  - If a fiber optic cable should be accidentally severed, do not look into the end. Doing so may result in serious eye injury.
  - Contact your local “diggers hot line” if available in your area, and/or the utility companies directly. Have them mark all underground utilities.

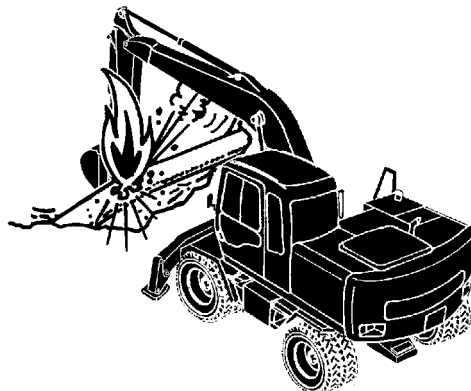

SA-086

027-E01A-0086-2

## OPERATE WITH CAUTION

- If the front attachment or any other part of the machine hits against an overhead obstacle, such as a bridge, both the machine and the overhead obstacle will be damaged, and personal injury may result as well.
  - Take care to avoid hitting overhead obstacles with the boom or arm.

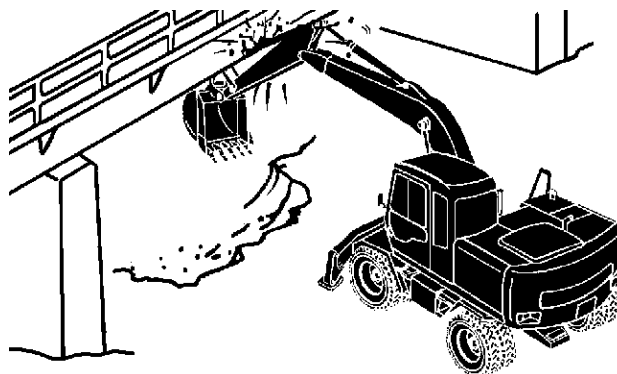

028-E01A-0087-2

SA-087

## AVOID POWER LINES

- Serious injury or death can result if the machine or front attachments are not kept a safe distance from electric lines.
  - When operating near an electric line, NEVER move any part of the machine or load closer than 3 m plus twice the line insulator length.
  - Check and comply with any local regulations that may apply.
  - Wet ground will expand the area that could cause any person on it to be affected by electric shock. Keep all bystanders or co-workers away from the site.

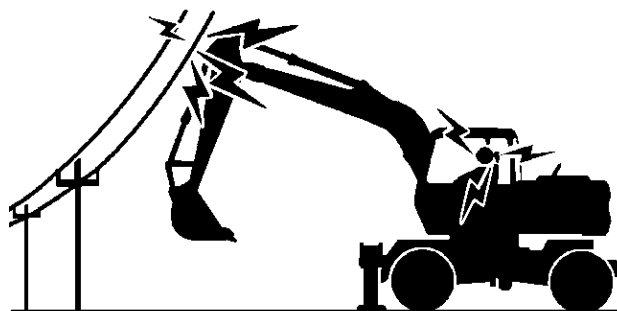

SA-089

029-E01A-0089-2

# SAFETY

---

## OBJECT HANDLING

- If a lifted load should fall, any person nearby may be struck by the falling load or may be crushed underneath it, resulting in serious injury or death.
  - When using the machine for craning operations, be sure to comply with all local regulations.
  - Do not use damaged chains or frayed cables, sables, slings, or ropes.
  - Before craning, position the front attachment with the position of the chassis at the front.
  - Move the load slowly and carefully. Never move it suddenly.
  - Keep all persons well away from the load.
  - Never move a load over a person's head.
  - Do not allow anyone to approach the load until it is safely and securely situated on supporting blocks or on the ground.
  - Never attach a sling or chain to the bucket teeth. They may come off, causing the load to fall.

032-E01A-0014

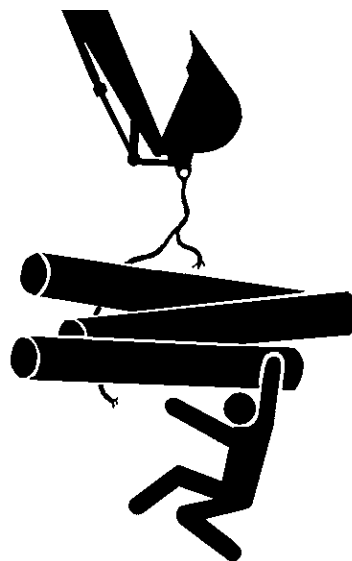

SA-014

---

## PROTECT AGAINST FLYING DEBRIS

- If flying debris hit eyes or any other part of the body, serious injury may result.
  - Guard against injury from flying pieces of metal or debris; wear goggles or safety glasses.
  - Keep bystanders away from the working area before striking any object.

031-E01A-0432

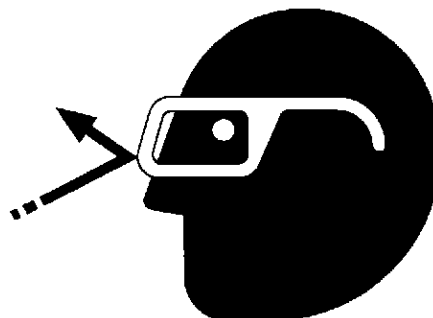

SA-432

# SAFETY

## PARK MACHINE SAFELY

To avoid accidents:

1. Park machine on a firm, level surface.
2. Lower bucket to the ground.
3. Place the shift lever in neutral, and put the brake switch in the P (parking brake) position.
4. Turn auto-idle switch and auto-acceleration switch off.
5. Run engine at slow idle speed without load for 5 minutes.
6. Turn key switch to OFF to stop engine.
7. Remove the key from the key switch.
8. Pull up the pilot shut-off lever to the LOCK position.
9. Close windows, roof vent, and cab door.
10. Lock all access doors and compartments.

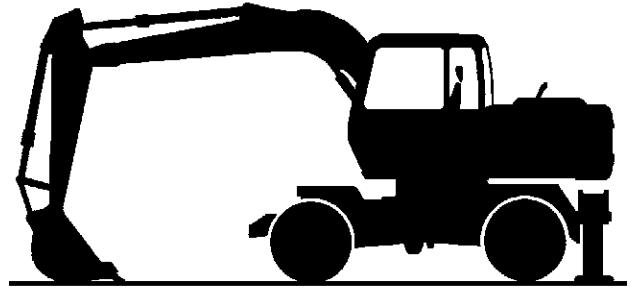

SA-093

033-E07B-0093

## HANDLE FLUIDS SAFELY- AVOID FIRES

- Handle fuel with care; it is highly flammable. If fuel ignites, an explosion and/or a fire may occur, possibly resulting in serious injury or death.
  - Do not refuel the machine while smoking or when near open flame or sparks.
  - Always stop the engine before refueling the machine.
  - Fill the fuel tank outdoors.
- All fuels, most lubricants, and some coolants are flammable.
  - Store flammable fluids well away from fire hazards.
  - Do not incinerate or puncture pressurized containers.
  - Do not store oily rags; they can ignite and burn spontaneously.
  - Securely tighten the fuel and oil filler cap.



SA-018



SA-019

034-E01A-0496

Thank you so much for reading.  
Please click the “Buy Now!”  
button below to download the  
complete manual.



After you pay.

You can download the most  
perfect and complete manual in  
the world immediately.

Our support email:

[ebooklibonline@outlook.com](mailto:ebooklibonline@outlook.com)