

Operator's Manual

ZAXIS

160LC-3

200LC-3

240LC-3

270LC-3

350LC-3

Hydraulic Excavator

Serial No.

ZAXIS160LC-3	010366 and up
ZAXIS200LC-3	202803 and up
ZAXIS240LC-3	021321 and up
ZAXIS270LC-3	021321 and up
ZAXIS350LC-3	052046 and up

INDEX

MACHINE NUMBERS

SAFETY

SAFETY SIGNS

COMPONENTS NAME

OPERATOR'S STATION

BREAK-IN

OPERATING THE ENGINE

DRIVING THE MACHINE

OPERATING THE MACHINE

TRANSPORTING

MAINTENANCE

MAINTENANCE UNDER SPECIAL ENVIRONMENTAL CONDITIONS

STORAGE

TROUBLESHOOTING

SPECIFICATIONS

INDEX

MACHINE NUMBERS

The manufacturing Nos. explained in this group is the individual number (serial No.) given to each machine and hydraulic components. These numbers are requested when inquiring any information on the machine and/or components. Fill these serial Nos. in the blank spaces in this group to immediately make them available upon request.

MACHINE

MODEL/TYPE: _____
 PRODUCT IDENTIFICATION NUMBER: _____

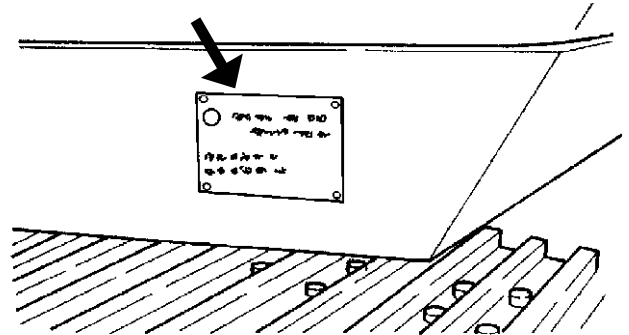

M157-00-001

PRODUCT IDENTIFICATION NUMBER

PRODUCT IDENTIFICATION NUMBER: _____

 **NOTE:** Marks to indicate the start and end of the PIN

HCM1U100L00100001

PRODUCT IDENTIFICATION NUMBER (PIN)

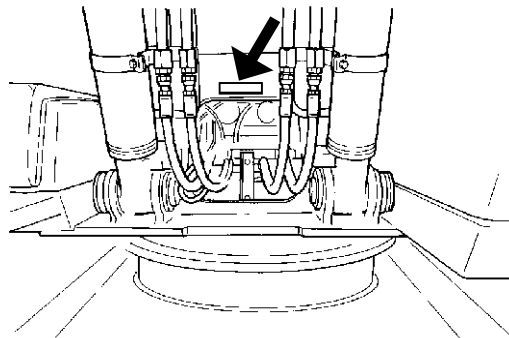

M157-12-008

ENGINE

TYPE: _____
 MFG. NO.: _____

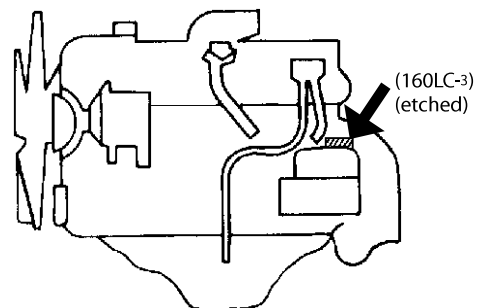

M178-00-002

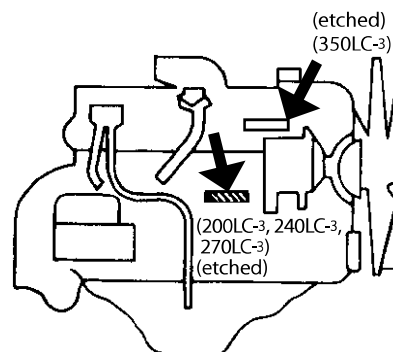

M1V1-00-001

MACHINE NUMBERS

TRAVEL MOTOR

TYPE: _____

MFG. NO.: _____

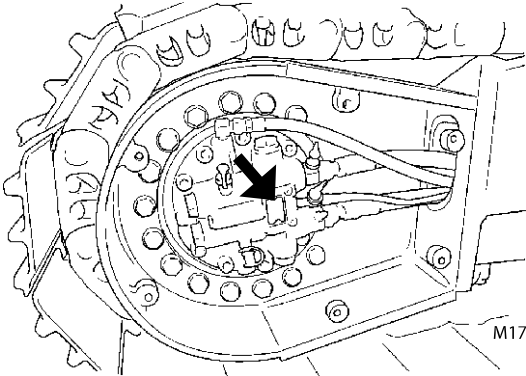

M178-07-047

SWING MOTOR

TYPE: _____

MFG. NO.: _____

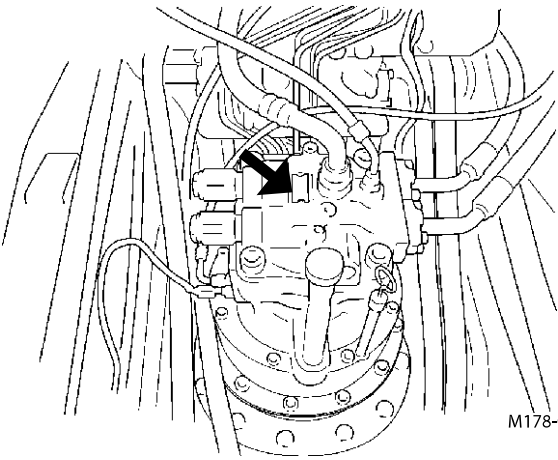

M178-07-014

MACHINE NUMBERS

HYDRAULIC PUMP

TYPE: _____

MFG. NO.: _____

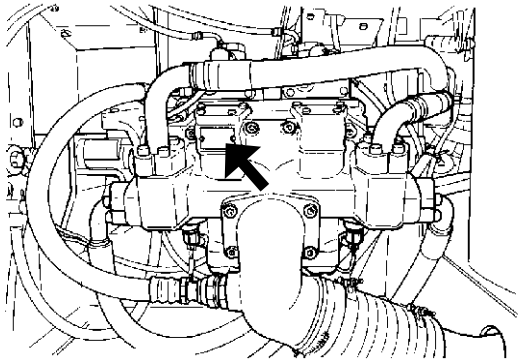

M157-00-004

MACHINE NUMBERS

MEMO

A series of horizontal dotted lines for writing.

CONTENTS

MACHINE NUMBERS

SAFETY

Recognize Safety Information	S-1
Understand Signal Words	S-1
Follow Safety Instructions	S-2
Prepare for Emergencies	S-2
Wear Protective Clothing	S-3
Protect Against Noise	S-3
Inspect Machine	S-3
General Precautions for Cab	S-4
Use Handholds and Steps	S-5
Adjust the Operator's Seat	S-5
Ensure Safety Before Rising from or Leaving Operator's Seat	S-5
Fasten Your Seat Belt	S-6
Move and Operate Machine Safely	S-6
Operate Only from Operator's Seat	S-7
Jump Starting	S-7
Keep Riders Off Machine	S-7
Precautions for Operations	S-8
Investigate Job Site Beforehand	S-9
Equipment of Head Guard, Rops, Fops	S-10
Provide Signals for Jobs Involving Multiple Numbers of Machines	S-10
Confirm Direction of Machine to Be Driven	S-10
Drive Machine Safely	S-11
Avoid Injury from Rollaway Accidents	S-13
Avoid Injury from Back-over and Swing Accidents	S-14
Keep Person Clear from Working Area	S-15
Never Position Bucket Over Anyone	S-15
Avoid Undercutting	S-15
Avoid Tipping	S-16
Never Undercut a High Bank	S-16
Dig with Caution	S-17
Operate with Caution	S-17
Avoid Power Lines	S-18
Precautions for Lightening	S-18
Object Handling	S-18
Protect Against Flying Debris	S-19
Park Machine Safely	S-19
Handle Fluids Safely—avoid Fires	S-19
Transport Safely	S-20
Practice Safe Maintenance	S-21
Warn Others of Service Work	S-22
Support Machine Properly	S-22
Stay Clear of Moving Parts	S-22
Prevent Parts from Flying	S-23
Store Attachments Safely	S-23
Prevent Burns	S-24
Replace Rubber Hoses Periodically	S-24
Avoid High-pressure Fluids	S-25
Prevent Fires	S-26
Evacuating in Case of Fire	S-27
Beware of Exhaust Fumes	S-27

Precautions for Welding and Grinding	S-27
Avoid Heating Near Pressurized Fluid Lines	S-28
Avoid Applying Heat to Lines Containing Flammable Fluids	S-28
Remove Paint Before Welding or Heating	S-28
Beware of Asbestos Dust	S-29
Prevent Battery Explosions	S-29
Service Air Conditioning System Safely	S-29
Handle Chemical Products Safely	S-30
Dispose of Waste Properly	S-30

SAFETY SIGNS	S-31
---------------------------	------

COMPONENTS NAME	1-1
------------------------------	-----

OPERATOR'S STATION

Cab Features	1-2
Multi Function Monitor	1-3
Outline	1-4
Menu Screen (23)	1-7
Hour Meter	1-8
Fuel Gauge	1-8
Clock	1-8
Menu Key	1-9
Optional Function Key	1-9
Return to Basic Screen Key	1-9
Alarm Light	1-9
Optional Function Display	1-9
Coolant Temperature Gauge	1-10
Operating Status Icon Display	1-10
Alarm Occurrence Screen	1-15
Contents of Alarms	1-17
Clock Setting	1-19
Attachment Selection (Only Machines Equipped with Optional Parts)	1-20
Pump 2 Flow Rate Adjustment (Only Machines Equipped with Optional Parts)	1-24
Displaying Operating Conditions	1-25
Fuel Rate Display/No Display	1-26
Maintenance Settings	1-33
Language Settings	1-38
Switch Panel	1-40
Engine Control Dial	1-41
Auto-idle Switch	1-41
Power Mode Switch	1-42
Travel Mode Switch	1-42
Work Light Switch	1-43
Wiper/Washer Switch	1-44
Switch Panel	1-45
Key Switch	1-47
Power Boost Switch	1-47
Horn Switch	1-47
Cigar Lighter	1-48
Cab Light	1-49
Pilot Control Shut-off Lever	1-50

CONTENTS

Engine Stop Switch.....	1-50	Auto-idle	5-8
Fuse Box.....	1-51	Work Mode	5-9
Auto Air Conditioner.....	1-52	Work Mode Select.....	5-10
Cab Heater Operation.....	1-55	Power Boost	5-11
Cooling Operation	1-56	Power Mode	5-12
Defroster Operation	1-56	Operating Backhoe.....	5-13
Tips for Optimal Air Conditioner Usage	1-58	Grading Operation.....	5-13
AM/FM Radio Operation	1-59	Face Shovel Operation	5-14
Digital Clock Setting Procedure	1-60	Avoid Abusive Operation	5-14
Cab Door Release Lever	1-61	Operating Tips.....	5-15
Opening Upper Front Window.....	1-61	Select Correct Track Shoes.....	5-15
Closing Upper Front Window.....	1-62	Hydraulic Breaker and Hydraulic Crusher.....	5-16
Removing and Storing Lower Front Window.....	1-63	Pipings for Breaker and Crusher	5-17
Opening Side Windows.....	1-63	Secondary Relief Pressure Adjustment	5-18
Opening/Closing Overhead Window.....	1-64	Precautions for Breaker Operation.....	5-19
Emergency Exit	1-65	Breaker Maintenance	5-22
Adjusting the Seat	1-66	Precautions for Crusher Operation	5-23
Adjusting Console Height.....	1-68	Attachment.....	5-25
Seat Belt.....	1-69	Attachment Connection Parts.....	5-29
BREAK-IN		Precaution for Arm Roll-in/bucket Roll-in Combined Operation — If Headguard-integrated Cab or Raingard Is Equipped.....	5-30
Observe Engine Operation Closely.....	2-1	When Installing an Attachment Longer Than Standard Bucket.....	5-30
Every 8 Hours or Daily.....	2-1	Shackle Hole Usage	5-31
After the First 50 Hours	2-1	Overnight Storage Instructions.....	5-31
After the First 100 Hours.....	2-1	Emergency Boom Lowering Procedure (Without Hose-rupture Safety Valve)	5-32
OPERATING THE ENGINE		Object Handling — If Equipped.....	5-33
Inspect Machine Daily Before Starting	3-1	TRANSPORTING	
Before Starting Engine	3-2	Transporting By Road	6-1
Starting the Engine in Ordinary Temperature.....	3-3	Loading/unloading on a Trailer.....	6-1
Starting in Cold Weather	3-4	Machine Lifting Procedure.....	6-5
Check Instruments After Starting.....	3-5	MAINTENANCE	
Using Booster Batteries.....	3-6	Correct Maintenance and Inspection Procedures.....	7-1
Stopping the Engine	3-8	Check the Hour Meter Regularly.....	7-2
DRIVING THE MACHINE		Use Correct Fuels and Lubricants	7-2
Drive the Machine Carefully	4-1	Layout.....	7-3
Steering the Machine Using Pedals.....	4-2	Maintenance Guide Table.....	7-4
Steering the Machine Using Levers	4-3	Prepare Machine for Maintenance.....	7-6
Travel Mode Switch	4-4	Hood and Access Covers.....	7-7
Travel Alarm	4-4	Periodic Replacement of Parts.....	7-9
Operating on Soft Ground	4-5	Maintenance Guide	7-10
Raise One Track Using Boom and Arm	4-5	A. Greasing.....	7-15
Towing Machine a Short Distance.....	4-6	Front Joint Pins.....	7-15
Operating in Water or Mud	4-7	Swing Bearing.....	7-17
Parking the Machine on Slopes.....	4-8	Swing Internal Gear	7-18
Parking the Machine	4-8	B. Engine.....	7-19
OPERATING THE MACHINE		Engine Oil Level.....	7-19
Control Lever (ISO Pattern)	5-1	Change Engine Oil	7-20
Control Lever (2 Way Multi Valve) (Optional).....	5-2	Replace Engine Oil Filter	7-20
Attachment Pedal (Hydraulic Breaker)(Optional)	5-3	C. Transmission.....	7-22
Attachment Pedal (Hydraulic Crusher)(Optional).....	5-4	Pump Transmission.....	7-22
Pilot Control Shut-off Lever	5-5		
Engine Speed Control.....	5-7		

CONTENTS

Swing Reduction Gear	7-23	Check and Replace EGR Device	7-82
Travel Reduction Gear	7-24	Check Tightening Torque of Bolts and Nuts	7-83
D. Hydraulic System	7-26	MAINTENANCE UNDER SPECIAL ENVIRONMENTAL CONDITIONS	
Inspection and Maintenance of Hydraulic Equipment...	7-26	Maintenance Under Special Environmental Conditions..	9-1
Breaker Maintenance	7-28	STORAGE	
Check Hydraulic Oil Level	7-29	Storing the Machine.....	10-1
Change Hydraulic Oil	7-30	Removing the Machine from Storage.....	10-2
Suction Filter Cleaning	7-30	Installing Vandal-proof Covers	10-3
Replace Hydraulic Tank Oil Filter	7-33	Help Prevent Crime.....	10-4
Replace Pilot Oil Filter	7-34	Record Identification Numbers	10-4
Replace Air Breather Element	7-35	Keep Proof of Ownership	10-4
Check Hoses and Lines	7-36	Park indoors Out of Sight	10-4
Service Recommendations for Hydraulic Fittings	7-39	When Parking Outdoors	10-5
E. Fuel System.....	7-41	Reduce Vandalism.....	10-5
Drain Fuel Tank Sump	7-43	Report Thefts Immediately	10-5
Drain Fuel Filter	7-44	TROUBLESHOOTING	
Replace Fuel Main Filter Element.....	7-48	Impossible to Start the Engine	11-1
Replace Fuel Pre-filter Element	7-49	Engine.....	11-2
Clean Fuel Solenoid Pump Strainer	7-50	Electrical System.....	11-6
Check Fuel Hoses.....	7-51	Mode Selection	11-8
F. Air Cleaner.....	7-52	Control Levers.....	11-9
Clean the Air Cleaner Outer Element	7-52	Hydraulic System	11-9
Replace the Air Cleaner Outer and Inner Elements...	7-52	SPECIFICATIONS	
G. Cooling System	7-54	Specifications (ZAXIS160LC-3).....	12-1
Check Coolant Level	7-56	Working Ranges (ZAXIS160LC-3).....	12-2
Check and Adjust Fan Belt Tension	7-57	Shoe Types and Applications (ZAXIS160LC-3)	12-3
Change Coolant	7-59	Bucket Types and Applications (ZAXIS160LC-3)	12-4
Clean Radiator Interior	7-59	Specifications (ZAXIS200LC-3).....	12-5
Clean Radiator, Oil Cooler Core and Inter Cooler	7-60	Working Ranges (ZAXIS200LC-3).....	12-6
Clean Oil Cooler, Radiator and Inter Cooler		Shoe Types and Applications (ZAXIS200LC-3)	12-7
Front Screen	7-60	Bucket Types and Applications (ZAXIS200LC-3)	12-8
Clean Air Conditioner Condenser.....	7-60	Specifications (ZAXIS240LC-3).....	12-9
Clean Fuel Oil Cooler	7-60	Working Ranges (ZAXIS240LC-3).....	12-10
Clean Air Conditioner Front Screen (Opt.)	7-60	Shoe Types and Applications (ZAXIS240LC-3)	12-11
H. Electrical System	7-61	Bucket Types and Applications (ZAXIS240LC-3)	12-12
Replace Batteries	7-64	Specifications (ZAXIS270LC-3).....	12-13
Remove and Installing Battery	7-65	Working Ranges (ZAXIS270LC-3).....	12-14
Replacing Fuses.....	7-65	Shoe Types and Applications (ZAXIS270LC-3)	12-15
I. Miscellaneous	7-67	Bucket Types and Applications (ZAXIS270LC-3)	12-16
Check Bucket Teeth.....	7-67	Specifications (ZAXIS350LC-3).....	12-17
Change Bucket	7-71	Working Ranges (ZAXIS350LC-3).....	12-18
Convert Bucket Connection Into Face Shovel.....	7-72	Shoe Types and Applications (ZAXIS350LC-3)	12-19
Adjust the Bucket Linkage	7-73	Bucket Types and Applications (ZAXIS350LC-3)	12-20
Remove the Travel Levers	7-74	INDEX	14-1
Check and Replace Seat Belt Check.....	7-74		
Check Windshield Washer Fluid Level.....	7-75		
Check Track Sag.....	7-76		
Clean and Replace Air Conditioner Filter			
Clean Filter	7-78		
Check the Air Conditioner	7-80		
Clean Cab Floor	7-81		
Retighten Cylinder Head Bolt	7-82		
Inspect and Adjust Valve Clearance.....	7-82		
Measure Engine Compression Pressure	7-82		
Check Starter and Alternator	7-82		

CONTENTS

MEMO

A series of horizontal dotted lines for writing a memo.

SAFETY

RECOGNIZE SAFETY INFORMATION

- These are the **SAFETY ALERT SYMBOLS**.
 - When you see these symbols on your machine or in this manual, be alert to the potential for personal injury.
 - Follow recommended precautions and safe operating practices.

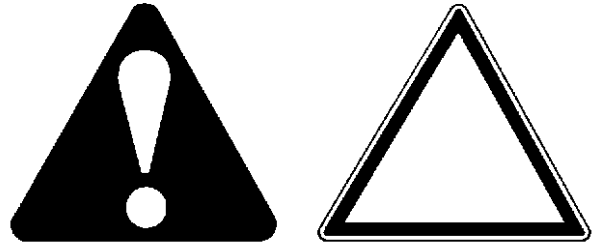

001-E01A-0001

SA-688

UNDERSTAND SIGNAL WORDS

- On machine safety signs, signal words designating the degree or level of hazard - **DANGER**, **WARNING**, or **CAUTION** - are used with the safety alert symbol.
 - **DANGER** indicates an imminently hazardous situation which, if not avoided, will result in death or serious injury.
 - **WARNING** indicates a potentially hazardous situation which, if not avoided, could result in death or serious injury.
 - **CAUTION** indicates a potentially hazardous situation which, if not avoided, may result in minor or moderate injury.
 - **DANGER or WARNING safety signs** are located near specific hazards. General precautions are listed on **CAUTION safety signs**.
 - Some safety signs don't use any of the designated signal words above after the safety alert symbol are occasionally used on this machine.
- To avoid confusing machine protection with personal safety messages, a signal word **IMPORTANT** indicates a situation which, if not avoided, could result in damage to the machine.
-  **NOTE** indicates an additional explanation for an element of information.



IMPORTANT



SA-1223

002-E01A-1223

SAFETY

FOLLOW SAFETY INSTRUCTIONS

- Carefully read and follow all safety signs on the machine and all safety messages in this manual.
- Safety signs should be installed, maintained and replaced when necessary.
 - If a safety sign or this manual is damaged or missing, order a replacement from your authorized dealer in the same way you order other replacement parts (be sure to state machine model and serial number when ordering).
- Learn how to operate the machine and its controls correctly and safely.
- Allow only trained, qualified, authorized personnel to operate the machine.
- Keep your machine in proper working condition.
 - Unauthorized modifications of the machine may impair its function and/or safety and affect machine life.
 - Do not modify any machine parts without authorization. Failure to do so may deteriorate the part safety, function, and/or service life. In addition, personal accident, machine trouble, and/or damage to material caused by unauthorized modifications will void Hitachi Warranty Policy.
 - Do not use attachments and/or optional parts or equipment not authorized by Hitachi. Failure to do so may deteriorate the safety, function, and/or service life of the machine. In addition, personal accident, machine trouble, and/or damage to material caused by using unauthorized attachments and/or optional parts or equipment will void Hitachi Warranty Policy.
- The safety messages in this SAFETY chapter are intended to illustrate basic safety procedures of machines. However it is impossible for these safety messages to cover every hazardous situation you may encounter. If you have any questions, you should first consult your supervisor and/or your authorized dealer before operating or performing maintenance work on the machine.

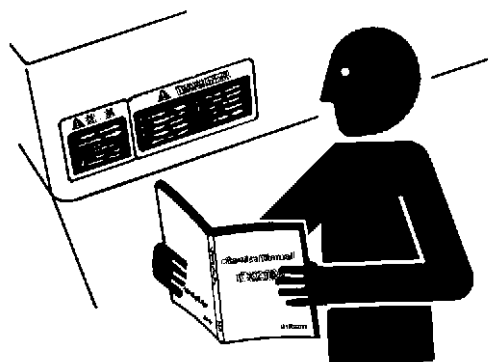

SA-003

003-E01B-0003

PREPARE FOR EMERGENCIES

- Be prepared if a fire starts or if an accident occurs.
 - Keep a first aid kit and fire extinguisher on hand.
 - Thoroughly read and understand the label attached on the fire extinguisher to use it properly.
 - To ensure that a fire-extinguisher can be always used when necessary, check and service the fire-extinguisher at the recommended intervals as specified in the fire-extinguisher manual.
 - Establish emergency procedure guidelines to cope with fires and accidents.
 - Keep emergency numbers for doctors, ambulance service, hospital, and fire department posted near your telephone.

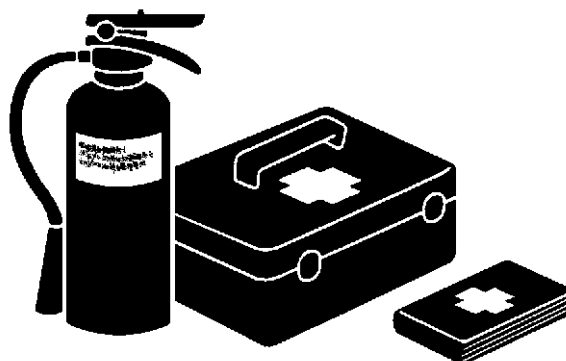

SA-437

004-E01A-0437

SAFETY

WEAR PROTECTIVE CLOTHING

- Wear close fitting clothing and safety equipment appropriate to the job.

You may need:

- A hard hat
- Safety shoes
- Safety glasses, goggles, or face shield
- Heavy gloves
- Hearing protection
- Reflective clothing
- Wet weather gear
- Respirator or filter mask.

Be sure to wear the correct equipment and clothing for the job. Do not take any chances.

- Avoid wearing loose clothing, jewelry, or other items that can catch on control levers or other parts of the machine.
- Operating equipment safely requires the full attention of the operator. Do not wear radio or music headphones while operating the machine.

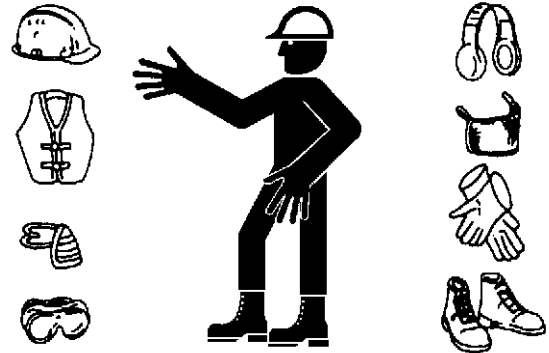

SA-438

005-E01A-0438

PROTECT AGAINST NOISE

- Prolonged exposure to loud noise can cause impairment or loss of hearing.
- Wear a suitable hearing protective device such as earmuffs or earplugs to protect against objectionable or uncomfortably loud noises.



006-E01A-0434

SA-434

INSPECT MACHINE

- Inspect your machine carefully each day or shift by walking around it before you start it to avoid personal injury.
- In the walk-around inspection be sure to cover all points described in the "PRE-START INSPECTION" chapter in the operator's manual.



007-E01A-0435

SA-435

SAFETY

GENERAL PRECAUTIONS FOR CAB

- Before entering the cab, thoroughly remove all dirt and/or oil from the soles of your work boots. If any controls such as a pedal is operated while with dirt and/or oil on the soles of the operator's work boots the operator's foot may slip off the pedal, possibly resulting in a personal accident.
- Do not leave parts and/or tools lying around the operator's seat. Store them in their specified locations.
- Avoid storing transparent bottles in the cab. Do not attach any transparent type window decorations on the windowpanes as they may focus sunlight, possibly starting a fire.
- Refrain from listening to the radio, or using music headphones or mobile telephones in the cab while operating the machine.
- Keep all flammable objects and/or explosives away from the machine.
- After using the ashtray, always cover it to extinguish the match and/or tobacco.
- Do not leave cigarette lighters in the cab. When the temperature in the cab increases, the lighter may explode.

524-E01A-0000

SAFETY

USE HANDHOLDS AND STEPS

- Falling is one of the major causes of personal injury.
 - When you get on and off the machine, always face the machine and maintain a three-point contact with the steps and handrails.
 - Do not use any controls as hand-holds.
 - Never jump on or off the machine. Never mount or dismount a moving machine.
 - Be careful of slippery conditions on platforms, steps, and handrails when leaving the machine.

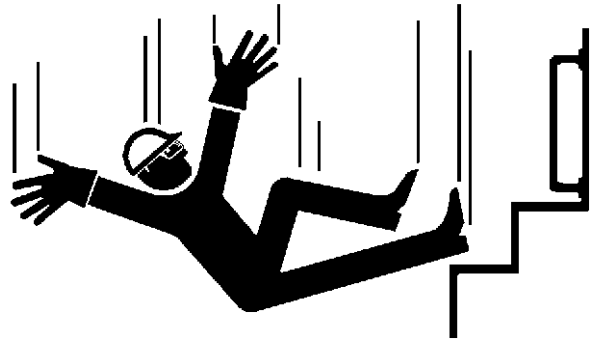

008-E01A-0439

SA-439

ADJUST THE OPERATOR'S SEAT

- A poorly adjusted seat for either the operator or for the work at hand may quickly fatigue the operator leading to misoperations.
 - The seat should be adjusted whenever changing the operator for the machine.
 - The operator should be able to fully depress the pedals and to correctly operate the control levers with his back against the seat back.
 - If not, move the seat forward or backward, and check again.
 - Adjust the rear view mirror position so that the best rear visibility is obtained from the operator's seat. If the mirror is broken, immediately replace it with a new one.



SA-378

009-E01A-0462

ENSURE SAFETY BEFORE RISING FROM OR LEAVING OPERATOR'S SEAT

- Before rising from the operator's seat to open/close either side window or to adjust the seat position, be sure to first lower the front attachment to the ground and then move the pilot control shut-off lever to the LOCK position. Failure to do so may allow the machine to unexpectedly move when a body part unintentionally comes in contact with a control lever, possibly resulting in serious personal injury or death.
 - Before leaving the machine, be sure to first lower the front attachment to the ground and then move the pilot control shut-off lever to the LOCK position. Turn the key switch OFF to stop the engine.
 - Before leaving the machine, close all windows, doors, and access covers and lock them up.

SAFETY

FASTEN YOUR SEAT BELT

- If the machine should overturn, the operator may become injured and/or thrown from the cab. Additionally the operator may be crushed by the overturning machine, resulting in serious injury or death.
- Prior to operating the machine, thoroughly examine webbing, buckle and attaching hardware. If any item is damaged or worn, replace the seat belt or component before operating the machine.
- Be sure to remain seated with the seat belt securely fastened at all times when the machine is in operation to minimize the chance of injury from an accident.
- We recommend that the seat belt be replaced every three years regardless of its apparent condition.

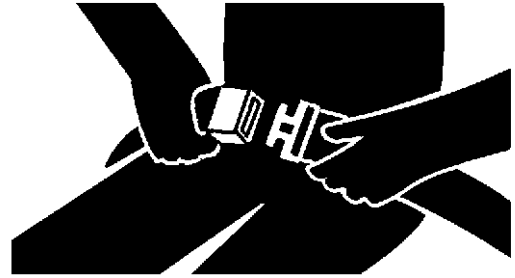

SA-237

010-E01A-0237

MOVE AND OPERATE MACHINE SAFELY

- Bystanders can be run over.
 - Take extra care not to run over bystanders. Confirm the location of bystanders before moving, swinging, or operating the machine.
 - Always keep the travel alarm and horn in working condition (if equipped). It warns people when the machine starts to move.
 - Use a signal person when moving, swinging, or operating the machine in congested areas. Coordinate hand signals before starting the machine.
 - Use appropriate illumination. Check that all lights are operable before operating the machine. If any faulty illumination is present, immediately repair it.

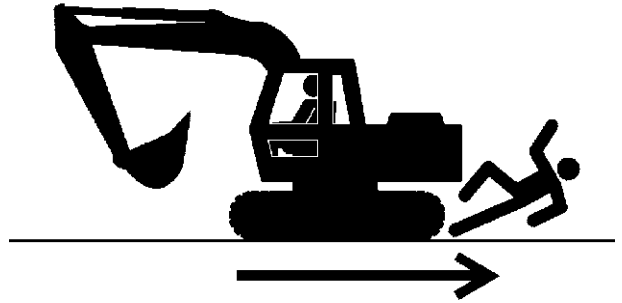

SA-426

011-E01A-0398

SAFETY

OPERATE ONLY FROM OPERATOR'S SEAT

- Inappropriate engine starting procedures may cause the machine to runaway, possibly resulting in serious injury or death.
 - Start the engine only when seated in the operator's seat.
 - NEVER start the engine while standing on the track or on ground.
 - Do not start engine by shorting across starter terminals.
 - Before starting the engine, confirm that all control levers are in neutral.
 - Before starting the engine, confirm the safety around the machine and sound the horn to alert bystanders.



012-E01B-0431

SA-444

JUMP STARTING

- Battery gas can explode, resulting in serious injury.
 - If the engine must be jump started, be sure to follow the instructions shown in the "OPERATING THE ENGINE" chapter in the operator's manual.
 - The operator must be in the operator's seat so that the machine will be under control when the engine starts. Jump starting is a two-person operation.
 - Never use a frozen battery.
 - Failure to follow correct jump starting procedures could result in a battery explosion or a runaway machine.

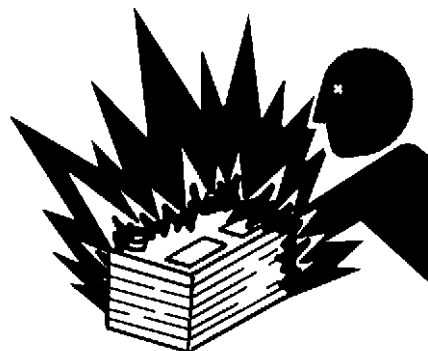

S013-E01A-0032

SA-032

KEEP RIDERS OFF MACHINE

- Riders on machine are subject to injury such as being struck by foreign objects and being thrown off the machine.
 - Only the operator should be on the machine. Keep riders off.
 - Riders also obstruct the operator's view, resulting in the machine being operated in an unsafe manner.



014-E01B-0427

SA-379

SAFETY

PRECAUTIONS FOR OPERATIONS

- Investigate the work site before starting operations.
- Be sure to wear close fitting clothing and safety equipment appropriate for the job, such as a hard hat, etc. when operating the machine.
- Clear all persons and obstacles from area of operation and machine movement.
Always beware of the surroundings while operating.
When working in a small area surrounded by obstacles, take care not to hit the upperstructure against obstacles.
- When loading onto trucks, bring the bucket over the truck beds from the rear side. Take care not to swing the bucket over the cab or over any person.

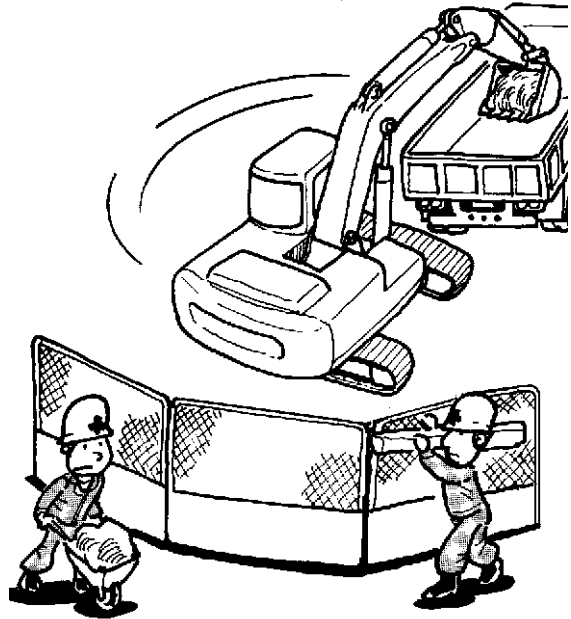

M104-05-015

SAFETY

INVESTIGATE JOB SITE BEFOREHAND

- When working at the edge of an excavation or on a road shoulder, the machine could tip over, possibly resulting in serious injury or death.
 - Investigate the configuration and ground conditions of the job site beforehand to prevent the machine from falling and to prevent the ground, stockpiles, or banks from collapsing.
 - Make a work plan. Use machines appropriate to the work and job site.
 - Reinforce ground, edges, and road shoulders as necessary. Keep the machine well back from the edges of excavations and road shoulders.
 - When working on an incline or on a road shoulder, employ a signal person as required.
 - Confirm that your machine is equipped a FOPS cab before working in areas where the possibility of falling stones or debris exist.
 - When the footing is weak, reinforce the ground before starting work.
 - When working on frozen ground, be extremely alert. As ambient temperatures rise, footing becomes loose and slippery.
 - Beware the possibility of fire when operating the machine near flammable objects such as dry grass.
- Make sure the worksite has sufficient strength to firmly support the machine.

When working close to an excavation or at road shoulders, operate the machine with the tracks positioned perpendicular to the cliff face with travel motors at the rear, so that the machine can more easily evacuate if the cliff face collapses.
- If working on the bottom of a cliff or a high bank is required, be sure to investigate the area first and confirm that no danger of the cliff or bank collapsing exists. If any possibility of cliff or bank collapsing exists, do not work on the area.
- Soft ground may collapse when operating the machine on it, possibly causing the machine to tip over. When working on a soft ground is required, be sure to reinforce the ground first using large pieces of steel plates strong and firm enough to easily support the machine.
- Note that there is always a possibility of machine tipping over when working on rough terrain or on slopes. Prevent machine tipping over from occurring. When operating on rough terrain or on slopes:
 - Reduce the engine speed.
 - Select slow travel speed mode.
 - Operate the machine slowly and be cautious with machine movements.

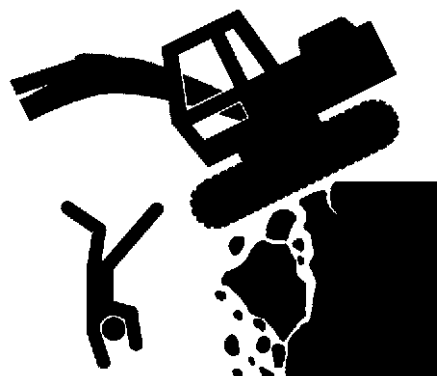

SA-380

SAFETY

EQUIPMENT OF HEAD GUARD, ROPS, FOPS

In case the machine is operated in areas where the possibility of falling stones or debris exist, equip a head guard, ROPS, or FOPS according to the potential hazardous conditions. (The standard cab for this machine corresponds to ROPS and FOPS.)

ROPS: Roll-Over Protective Structure
FOPS: Falling Object Protective Structure

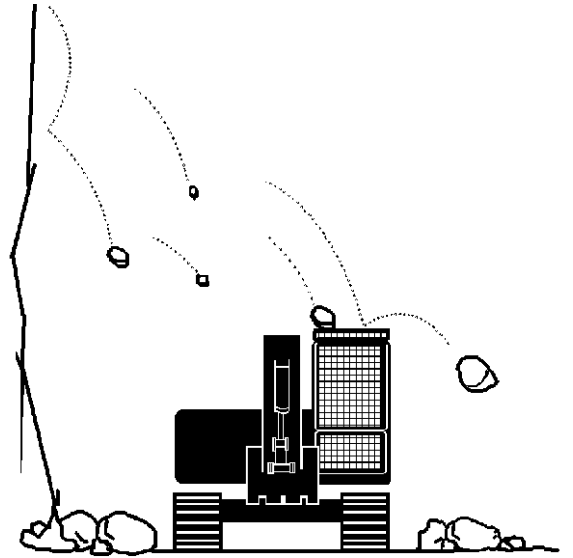

SA-490

PROVIDE SIGNALS FOR JOBS INVOLVING MULTIPLE NUMBERS OF MACHINES

- For jobs involving multiple numbers of machines, provide signals commonly known by all personnel involved. Also, appoint a signal person to coordinate the job site. Make sure that all personnel obey the signal person's directions.



018-E01A-0481

SA-481

CONFIRM DIRECTION OF MACHINE TO BE DRIVEN

- Incorrect travel pedal/lever operation may result in serious injury death.
- Before driving the machine, confirm the position of the undercarriage in relation to the operator's position. If the travel motors are located in front of the cab, the machine will move in reverse when travel pedals/levers are operated to the front.

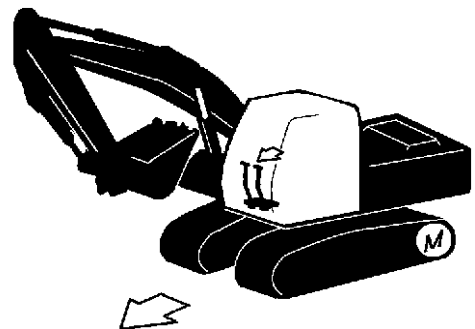

017-E01A-0491

SA-491

SAFETY

DRIVE MACHINE SAFELY

- Before driving the machine, always confirm that the travel levers/pedals direction corresponds to the direction you wish to drive.
 - Be sure to detour around any obstructions.
 - Avoid traveling over obstructions. Soil, fragments of rocks, and/or metal pieces may scatter around the machine. Don't allow personnel to stay around the machine while traveling.
- Driving on a slope may cause the machine to slip or overturn, possibly resulting in serious injury or death.
 - Never attempt to ascend or descend 35 degrees or steeper slopes.
 - Be sure to fasten the seat belt.
 - When driving up or down a slope, keep the bucket facing the direction of travel, approximately 0.5 to 1.0 m (A) above the ground.
 - If the machine starts to skid or becomes unstable, immediately lower the bucket to the ground and stop.

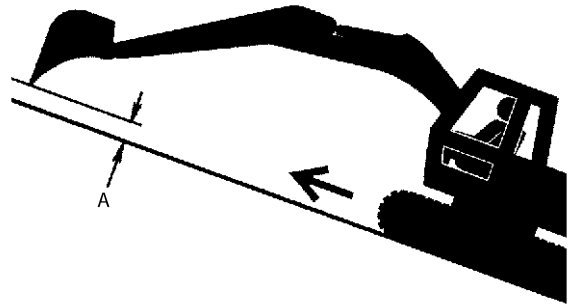

SA-657

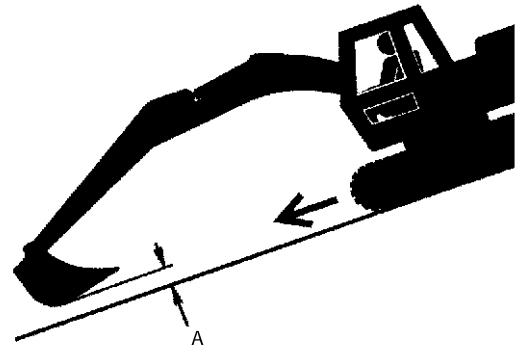

SA-658

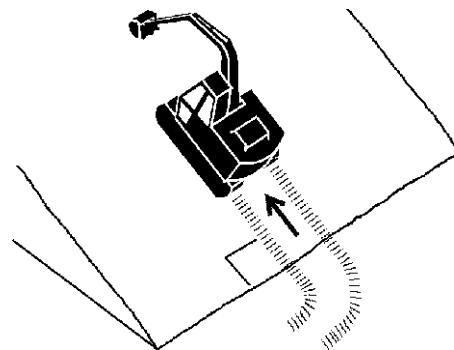

SA-441

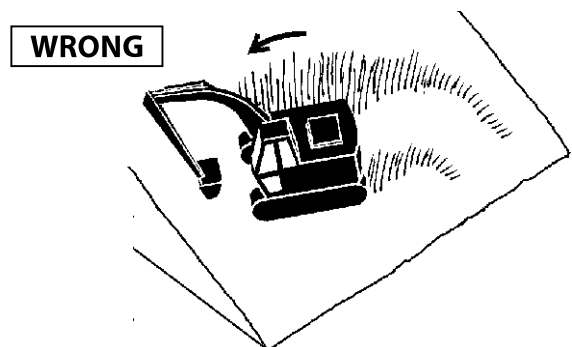

SA-442

Thank you so much for reading.
Please click the “Buy Now!”
button below to download the
complete manual.



After you pay.

You can download the most
perfect and complete manual in
the world immediately.

Our support email:

ebooklibonline@outlook.com