

Product: EXCAVATOR

Model: 322 L EXCAVATOR 8ML

Configuration: 322 L, 322 LN AND 322 N EXCAVATORS 8ML00001-UP (MACHINE) POWERED BY 3116 ENGINE

## **Operation and Maintenance Manual 322 L, 322 LN & 322 N EXCAVATORS**

Media Number -SEBU6851-02

Publication Date -20/02/1998

Date Updated -11/10/2001

## **Foreword**

SMCS - 7606

### **Literature Information**

This manual should be stored in the operator's compartment in the literature holder or seat back literature storage area.

This manual contains safety, operation, transportation, lubrication, and maintenance information.

Some photographs or illustrations in this publication show details or attachments that can be different from your machine. Guards and covers might have been removed for illustrative purposes.

Continuing improvement and advancement of product design might have caused changes to your machine which are not included in this publication. Read, study, and keep this manual with the machine.

Whenever a question arises regarding your machine, or this publication, please consult your Caterpillar dealer for the latest available information.

### **Safety**

The Safety Section lists basic safety precautions. In addition, this section identifies the text and locations of warning labels used on the machine.

Read and understand the basic precautions listed in the Safety Section before operating or performing lubrication, maintenance, and repair on this machine.

### **Operation**

The Operation Section is a reference for the new operator and a refresher for the experienced one. This section includes a discussion of gauges, switches, machine controls, implement controls, transportation, and towing information.

Photographs and illustrations guide the operator through correct procedures of checking, starting, operating, and stopping the machine.

Operating techniques outlined in this publication are basic. Skill and techniques develop as the operator gains knowledge of the machine and its capabilities.

## **Maintenance**

The Maintenance Section is a guide to equipment care. The illustrated, step-by-step instructions are grouped by servicing intervals. Items without specific intervals are listed under When Required topics. Items in the Maintenance Intervals chart are referenced to detailed instructions that follow.

### **Maintenance Intervals**

Use the service hour meter to determine servicing intervals. Calendar intervals shown (daily, weekly, monthly, etc.) can be used instead of service hour meter intervals if they provide more convenient servicing schedules and approximate the indicated service hour meter reading. Recommended service should always be performed at the interval that occurs first.

Under extremely severe, dusty, or wet operating conditions, more frequent lubrication than is specified in the Maintenance Intervals chart might be necessary.

Perform service on items at multiples of the original requirement. For example, at Every 500 Service Hours or 3 Months, also service those items listed under Every 250 Service Hours or Monthly, Every 50 Service Hours or Weekly and Every 10 Service Hours or Daily.

## **California Proposition 65**

Diesel engine exhaust and some of its constituents are known to the State of California to cause cancer, birth defects, and other reproductive harm.

## **Machine Description**



This machine is equipped with a 3116 direct injection turbocharged engine and other specifically developed systems and components such as electronic power unit control system, work mode choice system, two-speed travel motor, etc. The machine is designed primarily for excavating and loading material.

---

Product: EXCAVATOR

Model: 322 L EXCAVATOR 8ML

Configuration: 322 L, 322 LN AND 322 N EXCAVATORS 8ML00001-UP (MACHINE) POWERED BY 3116 ENGINE

## **Operation and Maintenance Manual 322 L, 322 LN & 322 N EXCAVATORS**

Media Number -SEBU6851-02

Publication Date -20/02/1998

Date Updated -11/10/2001

## **Safety**

SMCS - 7606

### **Warning Signs And Labels**

There are several specific warning signs and labels on your machine. The exact location and description of the hazards are reviewed in this section. Please take the time to familiarize yourself with these warning signs and labels.

Make sure that you can read all warning signs and labels. Clean or replace these if you cannot read the words or see the pictures. When cleaning the warning signs or labels use a cloth, water, and soap. Do not use solvent, gasoline, etc.

You must replace a warning sign or label if it is damaged, missing, or cannot be read. If a warning sign or label is on a part that is replaced, make sure a new warning sign or label is installed on the replaced part. See your Caterpillar dealer for new warning signs or labels.



**Do not operate or work on this machine unless you have read and understand the instructions and warnings in the Operation and Maintenance Guides. Failure to follow the instructions or heed the warnings could result in injury or death. Contact any Caterpillar dealer for replacement guides. Proper care is your responsibility.**

---

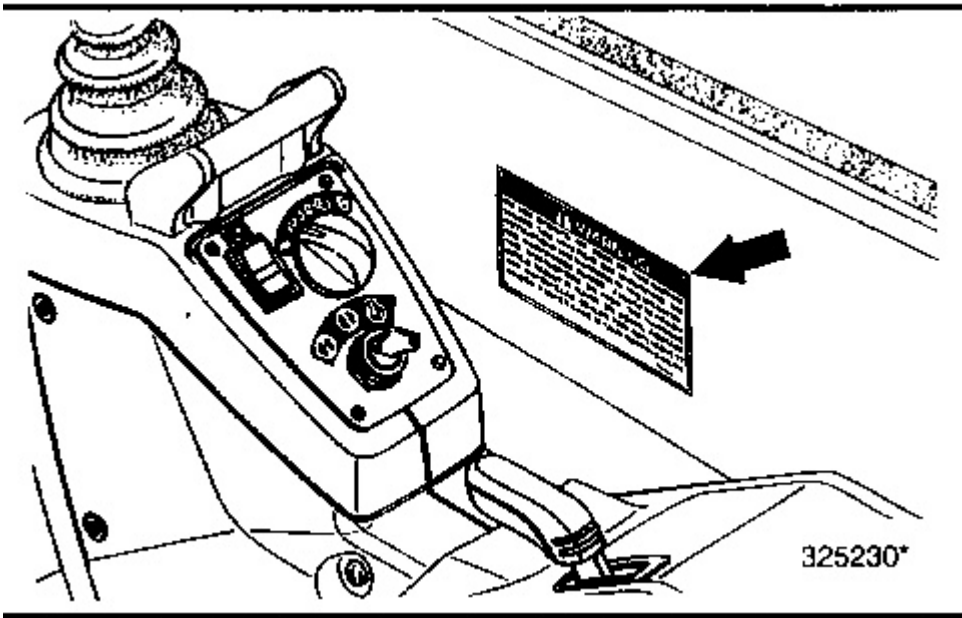

Located in the cab.

**! WARNING**

**Know the maximum height and reach of your machine. Serious injury or death by electrocution can occur if machine or attachments are not kept a safe distance from electrical power lines. Keep distance at least 3 m (10 feet) plus additional 10 mm (0.4 inch) for each 1,000 volts over 50,000 volts.**

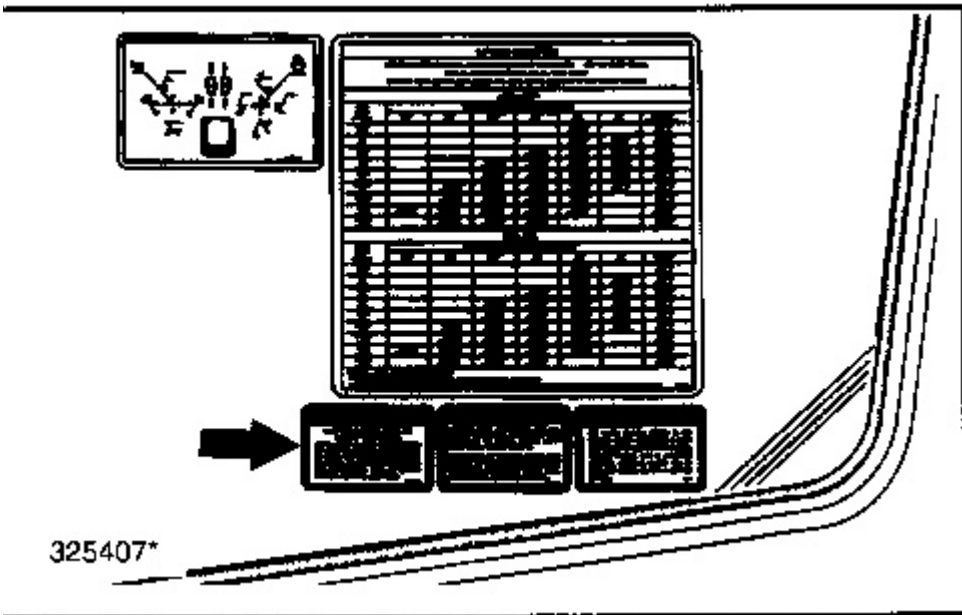

Located in the cab.

## **WARNING**

Improper jumper cable connections can cause explosion resulting in personal injury.

Batteries may be located in separate compartments. When using jumper cables, always connect positive (+) cable to positive (+) terminal of battery connected to starter solenoid and negative (-) cable from external source to starter negative (-) terminal (If machine not equipped with starter negative terminal, connect to engine block.) Follow procedure in the operation manual.

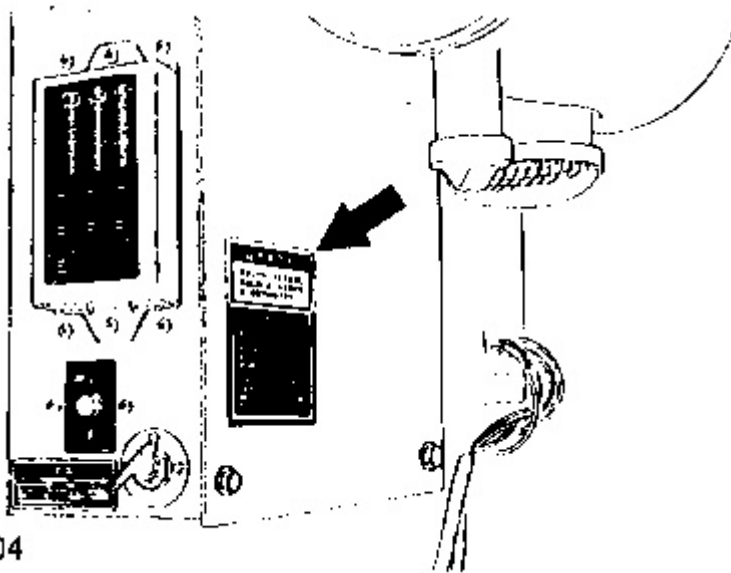

Located on the circuit breaker panel for earlier machines



Located behind the left access door for later machines.

## **WARNING**

**HYDRAULIC TANK**

**Relieve tank pressure with engine off by removing cap slowly to prevent burns from hot oil.**

---



Located on the hydraulic tank.

 **WARNING**

**Lift eyes or tank can fail when lifting tank containing fluids resulting in possible personal injury. Drain tank of all fluids before lifting.**

---



Located on the hydraulic tank and the fuel tank.

 **WARNING**

**SHUT OFF ENGINE**

**Shut off the engine and remove the key before performing maintenance or repairs.**

---

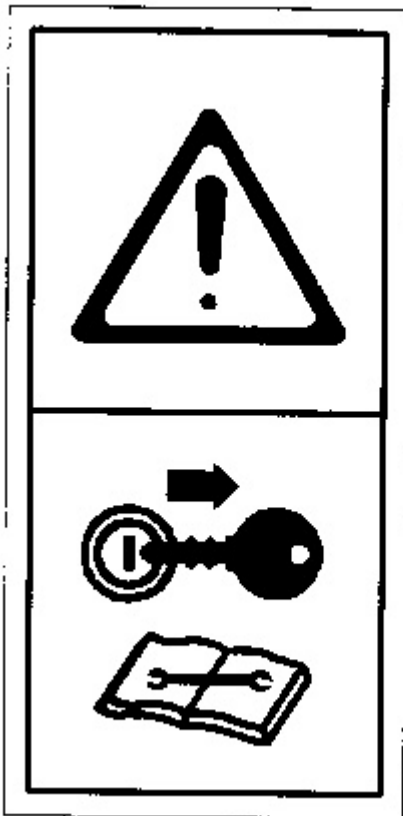

D66583

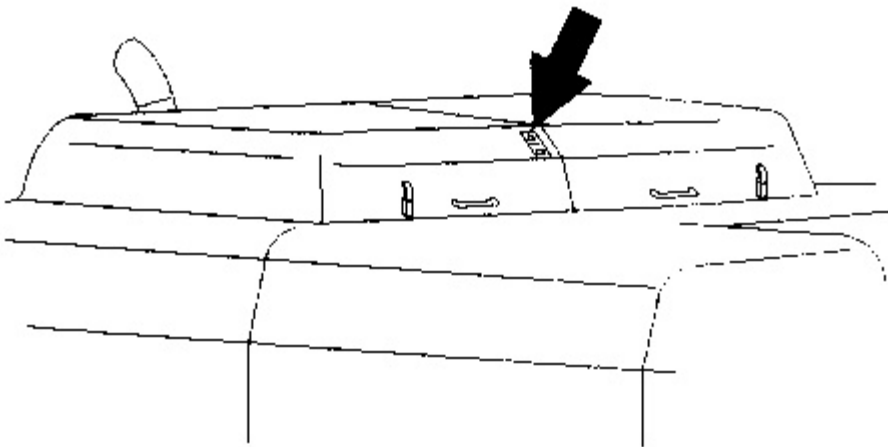

e17278

Located on the front of the hood.



### HIGH PRESSURE CYLINDER

**Do not remove or disassemble any hydraulic components or parts until pressure has been relieved or personal injury may occur.**

To relieve pressure:

1. Shut off engine.
2. With operator in seat and bucket on ground, engage neutralizing lever and actuate an implement control lever about ten times to dissipate pressure in hydraulic system.

<b>CHARGING MEDIUM:</b>	<b>NITROGEN</b>
<b>Precharge Pressure:</b>	<b>18 kg/cm<sup>2</sup> (256 psi)</b>
<b>Service Pressure:</b>	<b>35 kg/cm<sup>2</sup> (498 psi)</b>
<b>Minimum Bursting Pressure:</b>	<b>105 kg/cm<sup>2</sup> (1493 psi)</b>

---

See your Caterpillar dealer for tools and detailed information.

---



Located on the accumulator.



**WARNING**

#### **HIGH PRESSURE CYLINDER**

**Do not remove any parts until all pressure has been relieved to avoid possible personal injury. Relieve pressure by opening fill valve 1 turn maximum.**

---

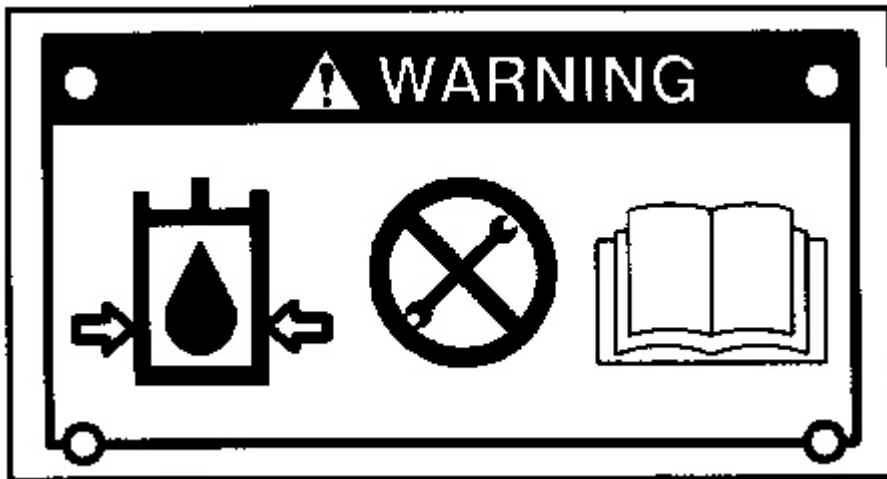

See the Maintenance Section of this manual for track adjustment procedure.

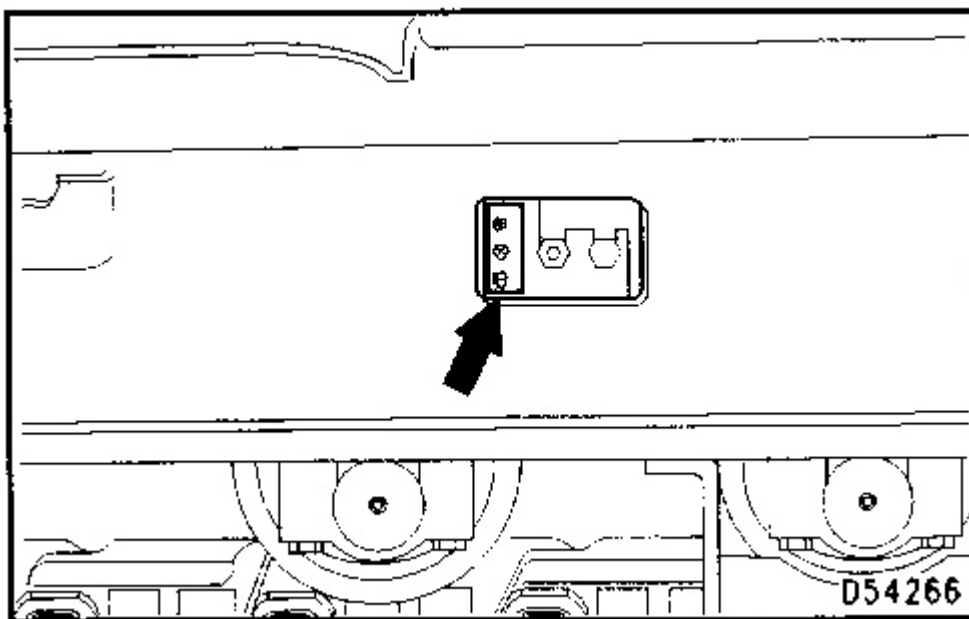

Located on both track frames.

 **WARNING**

**Automatic Engine Speed Control (AEC) will increase engine speed automatically when you operate the control lever(s) and/or travel pedals with AEC switch ON.**

**When loading and unloading machine from truck or working in close quarters always turn off AEC switch to prevent any possibility of sudden movement of machine, which could result in serious injury or death.**

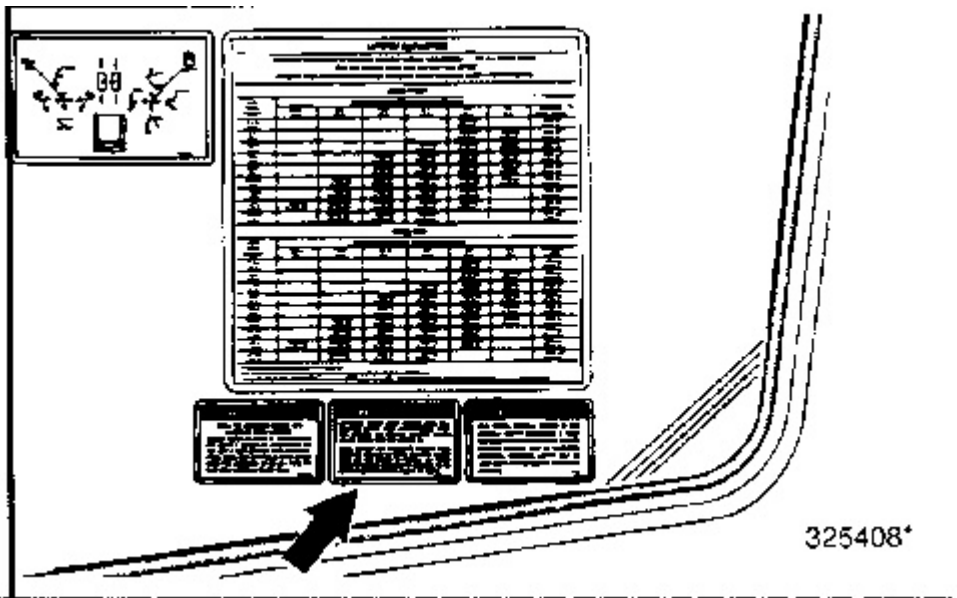

Located in the cab.

**! WARNING**

**Manufactured with 1.1.1-Trichloroethane, a substance which harms public health and environment by destroying the ozone in the upper atmosphere.**

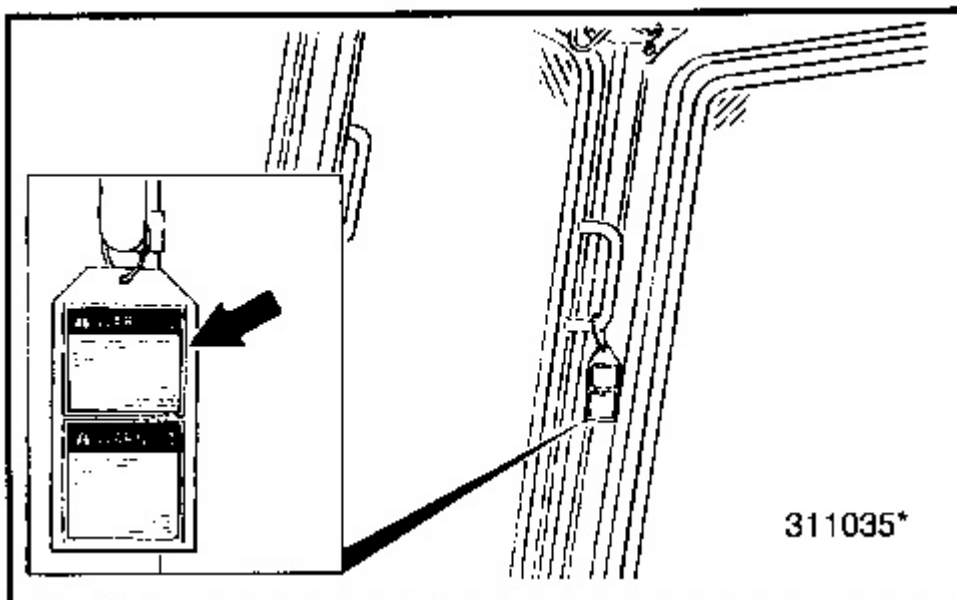

Located in the cab on machines equipped with an air conditioner with R-12 refrigerant.

**! WARNING**

**Contains Chlorofluorocarbon-12 a substance which harms public health and environment by destroying the ozone in the upper atmosphere.**

---

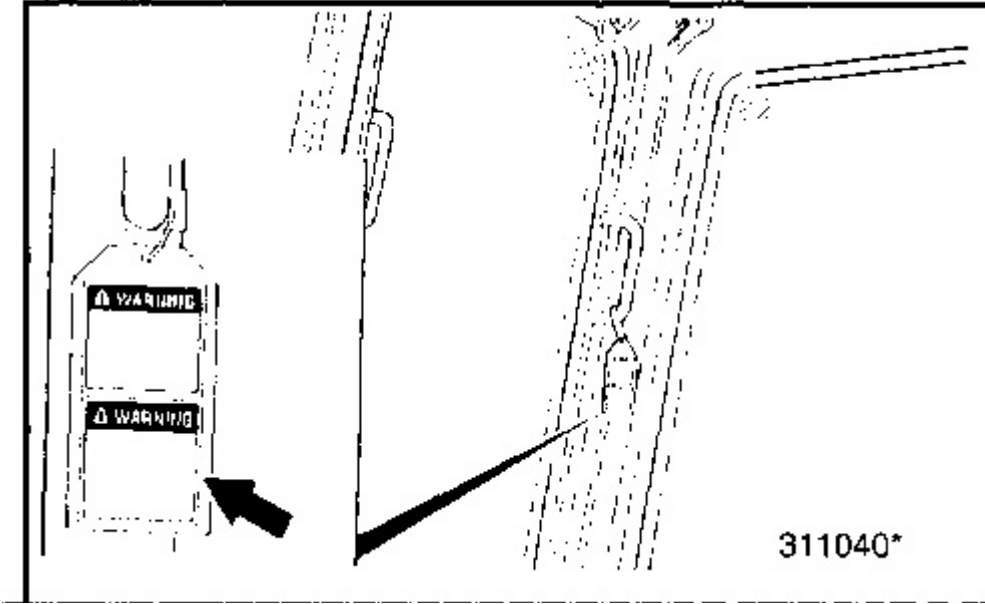

Located in the cab on machines equipped with an air conditioner with R-12 refrigerant.

**! WARNING**

**Put travel control switch in low position before descending a slope and loading or unloading on trailer. Machine control may be adversely affected. Personal injury can result from sudden change in machine control.**

---

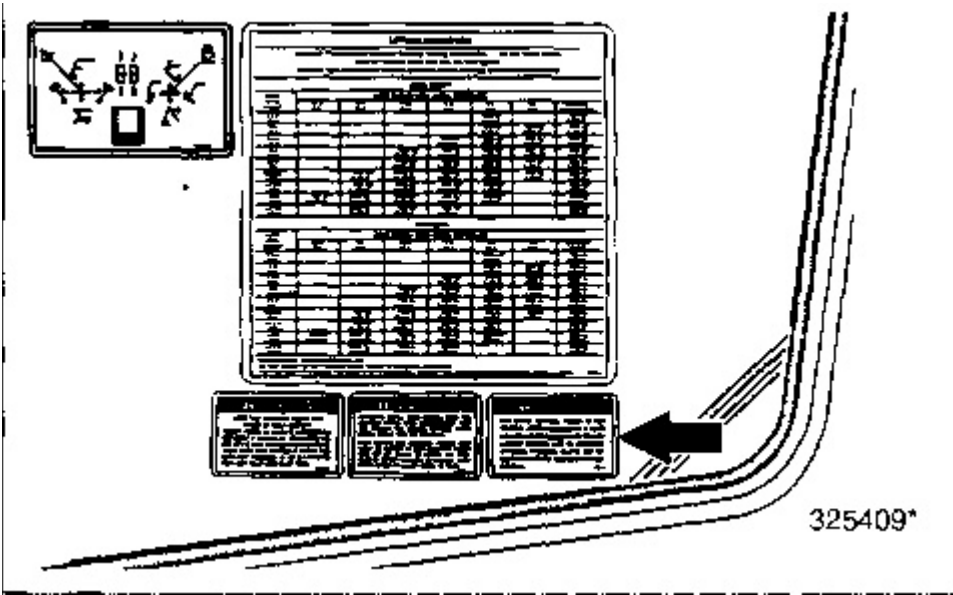

Located in the cab.

**! WARNING**

**Whenever a change is made to the machines control pattern also exchange the pattern card in the cab to match the new pattern. Follow the correct procedure in the Operation and Maintenance Manual.**

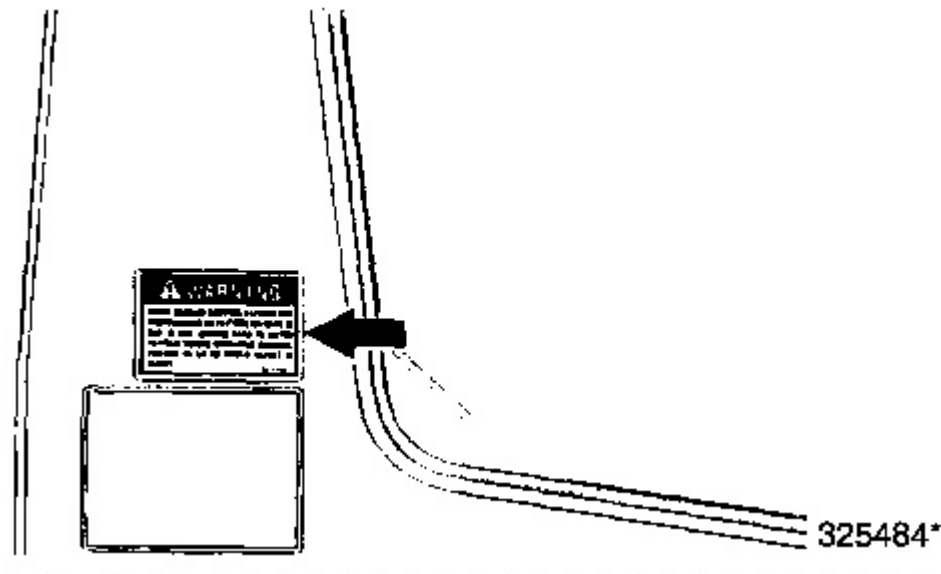

Located on the outside surface of the cab, if the machine is 2-way valve equipped.

**! WARNING**

**Check machine control pattern for conformance to pattern on card in cab. If not, change card to match pattern before operating machine. Failure to do so could result in injury.**

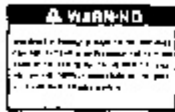

322209

Located in the cab, if the machine is 2-way valve equipped.



**WARNING**

**Structural damage, an overturn, modification alteration, or improper repair can impair this structure's protection capability thereby voiding this certification. Do not weld on or drill holes in the structure. Consult a Caterpillar dealer to determine this structure's limitations without voiding its certification.**

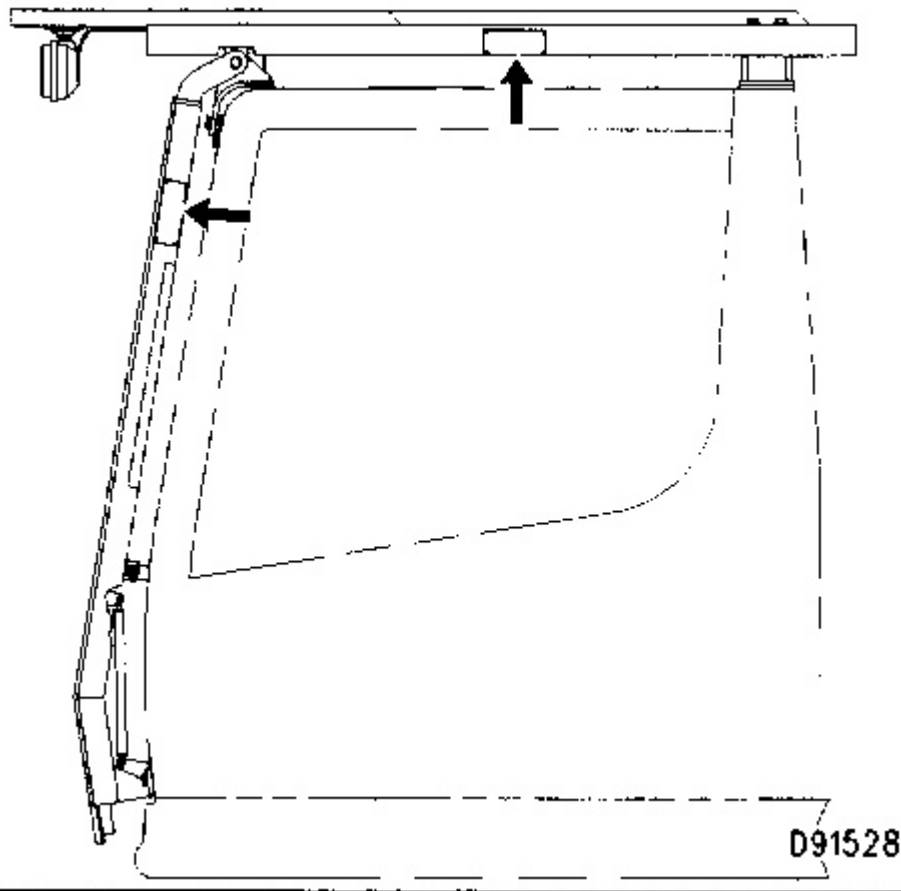

Located on the Fall Object Guard Structure (FOGS), if equipped.

### **General Hazard Information**

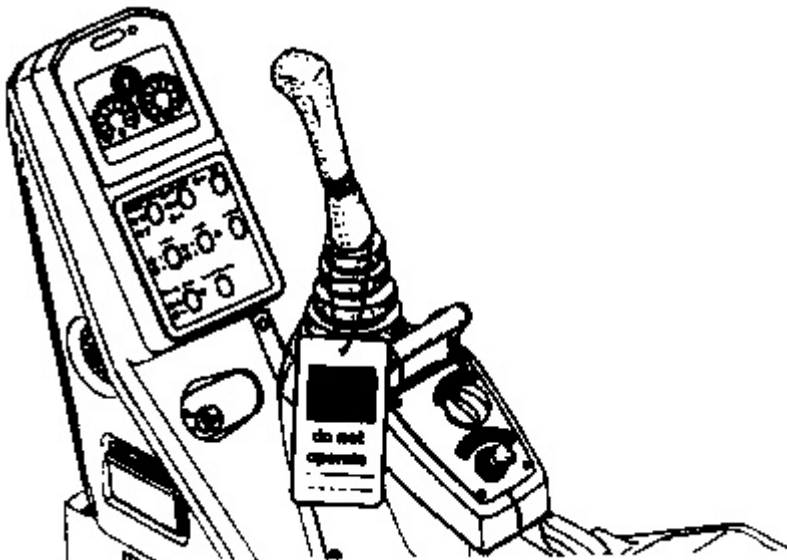

Attach a DO NOT OPERATE, SEHS7332, or similar warning tag to the start switch or controls before servicing or repairing the machine. This tag is available from your Caterpillar dealer.

For machines equipped with an automatic swing parking brake, disregard the instructions for machines equipped with a swing locking pin.

Know the width of your implements so proper clearance can be maintained when operating near fences, boundary obstacles, etc.

Wear a hard hat, protective glasses, and other protective equipment as required by job conditions.

Do not wear loose clothing or jewelry that can catch on controls or other parts of the machine.

Make certain all protective guards and covers are secured in place on the machine.

Keep the machine, especially the deck, walkways, and steps, free of foreign material, such as debris, oil, tools, and other items which are not part of the machine.

Secure all loose items such as lunch boxes, tools, and other items which are not part of the machine.

Know the appropriate work-site hand signals and who gives them. Accept signals from one person only.

Inhaling air conditioner refrigerant gas through a lit cigarette or other smoking method or inhaling fumes released from a flame containing air conditioner refrigerant gas can cause bodily harm or death. Do not smoke when servicing air conditioners or whenever refrigerant gas may be present.

Never put maintenance fluids into glass containers.

Use all cleaning solutions with care.

Report all needed repairs.

Do not allow unauthorized personnel on the machine.

- \* Park the machine on level ground.
- \* Lower the implements to the ground.
- \* Move the implement control levers to the HOLD position.
- \* Move the hydraulic activation control lever to the LOCKED position.
- \* Stop the engine.
- \* Turn the engine start switch off and remove the key.
- \* Turn the disconnect switch off and remove the key.

### **Falling Objects Guard**

This is an attachment guard located above the operator's compartment and secured to the machine.

To avoid possible weakening of the Falling Objects Guard, consult a Caterpillar dealer before altering the Falling Objects Guard in any way. The protection offered by this Falling Objects Guard will be impaired if it has been subjected to structural damage. Structural damage can be caused by an overturn accident, by falling objects, etc.

### **Pressure Air**

Pressure air can cause personal injury. When using pressure air for cleaning, wear a protective face shield, protective clothing, and protective shoes.

The maximum air pressure must be below 205 kPa (30 psi) for cleaning purposes.

## **Fluid Penetration**

Pressure can be maintained in the hydraulic circuit long after the engine has been stopped. The pressure can cause hydraulic fluid or items such as pipe plugs to shoot-out at high speed if pressure is not relieved correctly.

Do not remove or disassemble any hydraulic components or parts until the pressure has been relieved or personal injury may occur. To relieve pressure:

1. STOP the engine.
2. With an operator in the seat and the bucket or the attachment on the ground, engage the neutralizing lever and actuate an implement control lever about 10 times to dissipate the pressure in the hydraulic system.

Always use a board or cardboard when checking for a leak. Escaping fluid under pressure, even a pinhole leak, can penetrate body tissue causing serious injury and possible death. If fluid is injected into the skin, it must be treated by a doctor familiar with this type of injury immediately.

Track adjusting grease is under high pressure. Grease coming out of the relief valve under pressure can penetrate the body causing injury or death.

Do not watch the relief valve to see if grease is escaping. Watch the track or track adjustment cylinder to see if the track is being loosened. Loosen the relief valve one turn only.

## **Containing Fluid Spillage**

Care must be taken in order to ensure that fluids are contained during the performance of an inspection, maintenance, testing, adjusting, or repair of the machine. Be prepared to collect the fluids with suitable containers before opening any compartment or disassembling any component containing fluids.

Refer to Special Publication, NENG2500, "Tools and Shop Products Guide" for tools and equipment which are suitable for collecting and containing fluids.

Obey all local regulations for the disposal of liquids.

## **Asbestos Information**

This Caterpillar machine and replacement parts shipped from the factory are asbestos free. Caterpillar recommends the use of only genuine Caterpillar replacement parts. If any replacement parts containing asbestos are used, the following guidelines should be used in handling these parts and asbestos debris.

Caution should be used to avoid breathing dust that might be generated when handling components containing asbestos fibers. If this dust is inhaled, it can be hazardous to your health. Components that could be installed in Caterpillar products that might contain asbestos fibers are brake pads, brake band and lining assemblies, clutch plates, and some gaskets. The asbestos used in these components is usually bound in a resin or sealed in some way. Normal handling is not hazardous as long as airborne dust which contains asbestos is not generated.

If dust which can contain asbestos is present, there are several common sense guidelines that should be followed.

- \* Never use compressed air for cleaning.
- \* Avoid brushing or grinding of asbestos containing materials.
- \* For clean up, use wet methods or a vacuum equipped with a high efficiency particulate air (HEPA) filter.
- \* Use exhaust ventilation on permanent machining jobs.
- \* Wear an approved respirator if there is no other way to control the dust.
- \* Comply with applicable rules and regulations for the work place (for example in the U.S.A., OSHA requirements as set forth in 29 CFR 1910.1001).
- \* Follow environmental rules and regulations for disposal of asbestos.
- \* Avoid areas where asbestos particles might be in the air.

## **Crushing Or Cutting Prevention**

Support equipment and implements properly when working beneath them. Do not depend on hydraulic cylinders to hold them up. An implement may fall if a control is moved, or if a hydraulic line breaks.

Never attempt adjustments while the machine is moving or the engine is running unless otherwise specified.

Where there are implement linkages, the clearance in the linkage area will increase or decrease with movement of the implement.

Stay clear of all rotating and moving parts.

Keep objects away from moving fan blades. They will throw or cut any object or tool that falls or is pushed into them.

Do not use a kinked or frayed wire rope cable. Wear gloves when handling a wire rope cable.

Retainer pins, when struck with force, can fly out and injure nearby persons. Make sure the area is clear of people when driving retainer pins.

Wear protective glasses when striking a retainer pin to avoid injury to your eyes.

Chips or other debris can fly off objects when struck. Make sure no one can be injured by flying debris before striking any object.

Do not attempt to lift the machine with the lift eyes on the cab or counterweight. Refer to the lifting instructions included in the Transportation Information portion of the Operation Section, or consult your Caterpillar dealer for lifting instructions.

## **Burn Prevention**

### **Coolant**

At operating temperature, the engine coolant is hot and under pressure. The radiator and all lines to heaters or the engine contain hot water or steam. Any contact can cause severe burns.

Steam can cause personal injury.

Check the coolant level only after the engine has been stopped and the fill cap is cool enough to remove with your bare hand.

Remove the cooling system fill cap slowly to relieve pressure.

Cooling system additive contains alkali that can cause personal injury. Avoid contact with the skin, eyes, and mouth.

Allow cooling system components to cool before draining.

## **Oils**

Hot oil and components can cause personal injury. Do not allow hot oil or components to contact the skin.

At operating temperature, the hydraulic tank is hot and can be under pressure.

To relieve the pressure from the hydraulic tank, remove the hydraulic tank pressure cap located on the rear of the hydraulic tank.

Remove the hydraulic tank pressure cap only after the engine has been stopped and the pressure cap is cool enough to remove with your bare hand.

Remove the hydraulic tank pressure cap slowly to relieve pressure.

Relieve all pressure in air, oil, fuel, or cooling systems before any lines, fittings, or related items are disconnected or removed.

## **Batteries**

Batteries give off flammable fumes which can explode.

Do not smoke when observing the battery electrolyte levels.

Electrolyte is an acid and can cause personal injury if it contacts skin or eyes.

Always wear protective glasses when working with batteries.

## **Fire Or Explosion Prevention**

All fuels, most lubricants, and some coolant mixtures are flammable.

Fuel leaked or spilled onto hot surfaces or electrical components can cause a fire.

Do not smoke while refueling or in a refueling area.

Do not smoke in areas where batteries are charged, or where flammable materials are stored.

Batteries can be located in separate compartments. When using jumper cables, always connect the positive (+) jumper cable to the positive (+) terminal of the battery that is connected to the starter solenoid. Connect the negative (-) jumper cable to the starter motor negative (-) terminal. (If not equipped with a starter motor negative (-) terminal, connect to the engine block.)

See the Operation Section of this manual for specific starting instructions.

Clean and tighten all electrical connections. Check daily for loose or frayed electrical wires. Have all loose or frayed electrical wires tightened, repaired or replaced before operating the machine.

Keep all fuels and lubricants stored in properly marked containers and away from all unauthorized persons.

Store all oily rags or other flammable material in a protective container, in a safe place.

Do not weld or flame cut on pipes or tubes that contain flammable fluids. Clean them thoroughly with nonflammable solvent before welding or flame cutting on them.

Remove all flammable materials such as fuel, oil, and other debris before they accumulate on the machine.

Do not expose the machine to flames, burning brush, etc., if at all possible.

Shields, which protect hot exhaust components from oil or fuel spray in the event of a line, tube, or seal failure, must be installed correctly.

### **Fire Extinguisher**



Have a fire extinguisher available and know how to use it. Inspect and have the fire extinguisher serviced as recommended on its instruction plate. The fire extinguisher may be mounted behind the cab on top of the hood.

### **Ether**

Read and follow the ether manufacturer's instructions when using ether to start a machine.

Ether is poisonous and flammable.

Breathing ether vapors or repeated contact of ether with skin can cause personal injury.

Use ether only in well ventilated areas.

Do not smoke while changing ether cylinders.

Use ether with care to avoid fires.

Do not store replacement ether cylinders in living areas or in the operator's compartment.

Do not store ether cylinders in direct sunlight or at temperatures above 39°C (102°F).

Discard cylinders in a safe place. Do not puncture or burn cylinders.

Keep ether cylinders out of the reach of unauthorized personnel.

Thank you so much for reading.  
Please click the “Buy Now!”  
button below to download the  
complete manual.



After you pay.

You can download the most  
perfect and complete manual in  
the world immediately.

Our support email:

[ebooklibonline@outlook.com](mailto:ebooklibonline@outlook.com)