

PU12405

KEY	PART NO.	PART NAME	QTY	REMARKS
1	M147294	VALVE COVER	1	RH
2	19M8903	SCREW	11	M6 X 30
3	MIU11493	BOLT	8	
4	M147297	GASKET	2	
5	MIU11492	BOLT	4	
6	M68144	STUD	4	MARKED FD750D-JS12; ORDER MIU11949
6	MIU11949	BOLT	1	
7	AM132281	CYLINDER HEAD	1	ORDER MIU14324; RH
7	MIU14324	CYLINDER HEAD	1	MARKED FD750D-NS12; RH
8	M147293	ENGINE CYLINDER HEAD GASKET	2	
9	MIU14325	CYLINDER HEAD	1	SUB FOR AM132282
10	M147295	VALVE COVER	1	LH
11	M77734	CLAMP	2	
12	M147307	TUBE	1	
13	19M7868	SCREW	4	M8 X 30
14	M147299	COVER	1	
15	M95848	SCREW	2	
16	M147298	PLATE	2	
17	M147300	VALVE	2	Breather
18	M147296	GASKET	1	
19	M147302	SEAL	1	
20	MIU12134	BEARING	1	
21	M127431	ADAPTER FITTING	3	USE WITH AM132283
21	MIU13767	ADAPTER FITTING	1	MARKED FD750D-NS12
22	MIA12868	CRANKCASE	1	SUB FOR AM132283
22	MIA12868	CRANKCASE	1	MARKED FD750D-NS12
23	M70227	PIN	6	
24	M76104	O-RING	3	
25	MIU10833	SEAL	1	
26	19M8318	SCREW	6	M8 X 45
27	M139490	BOLT	4	MARKED FD750D-JS12
27	MIU11385	BOLT	1	MARKED FD750D-NS12
28	MIA12867	CRANKCASE	1	SUB FOR M147763; Cover
29	M147303	SEAL	1	

KEY	PART NO.	PART NAME	QTY	REMARKS
30	24M7095	WASHER	12	8.400 X 15 X 1.600 mm, Head Bolt
31	MIU14326	BEARING	1	USE WITH MIA12867
32	M70227	PIN	6	
33	M94242	BOLT	8	(Not Illustrated)
34	MIA12032	GASOLINE ENGINE	1	(Not Illustrated) MARKED FD750D-HS12; ORDER MIA12550
34	MIA12550	GASOLINE ENGINE	1	(Not Illustrated) MARKED FD750D-JS12; ORDER MIA12563
34	MIA12563	GASOLINE ENGINE	1	(Not Illustrated) MARKED FD750D-KS12; ORDER MIA12669
34	MIA12669	GASOLINE ENGINE	1	(Not Illustrated) MARKED FD750D-MS12; ORDER MIA12821
34	MIA12821	GASOLINE ENGINE	1	(Not Illustrated) MARKED FD750D-NS12
35	MIA12917	SHORT BLOCK ASSEMBLY	1	(Not Illustrated) SUB FOR MIA11876

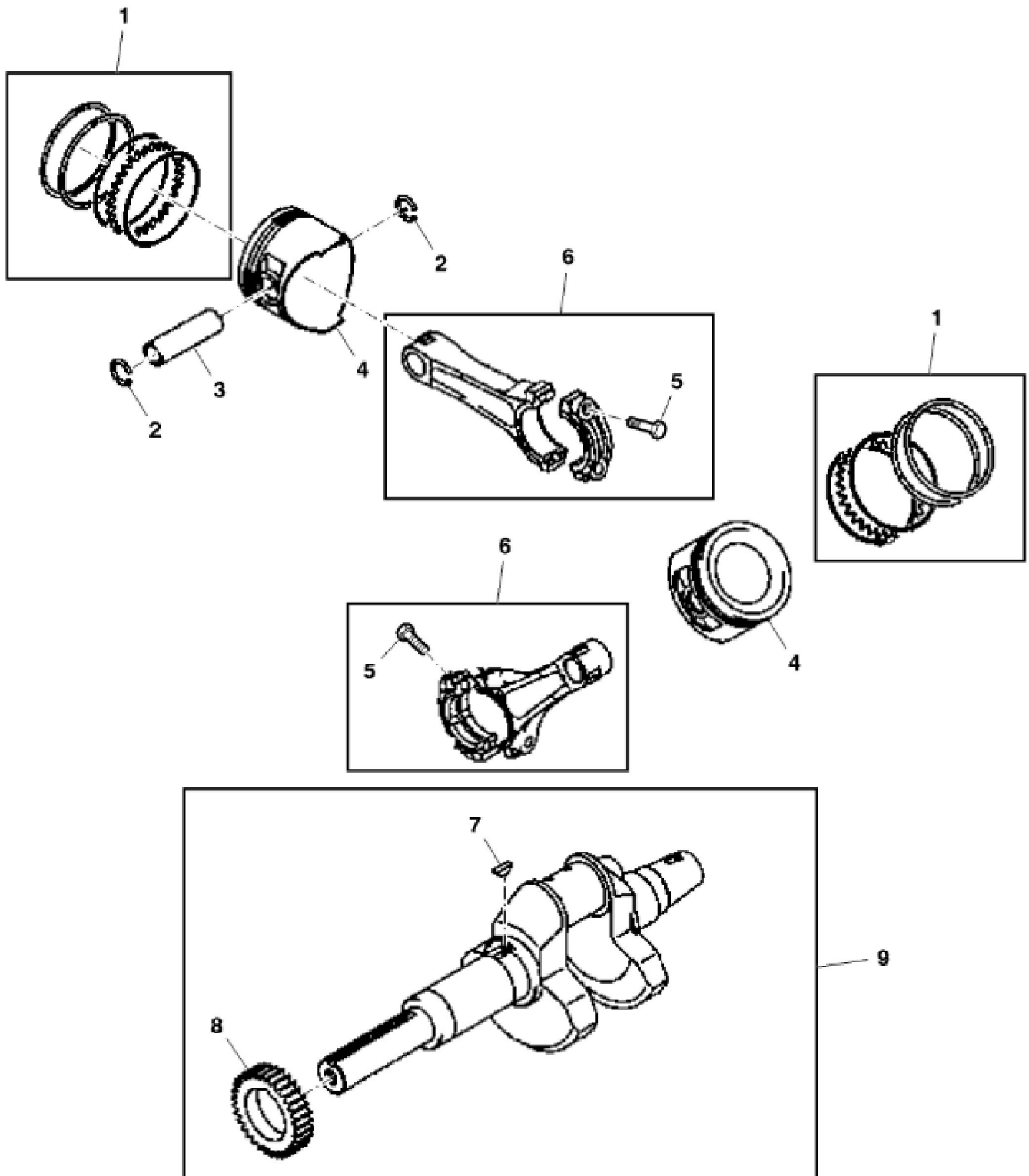

John Deere > Turf And Utility >TRACTOR, LAWN AND GARDEN >X734 - TRACTOR, LAWN AND GARDEN >X734 Signature Series Tractor >20 ENGINE MM16177 >ST747646 - CRANKSHAFT AND PISTON ASSEMBLY

KEY	PART NO.	PART NAME	QTY	REMARKS
1	AM102610	PISTON RING KIT	2	
1	AM102612	PISTON RING KIT	2	0.50 mm, OS
2	M70220	SNAP RING	4	
3	M70219	PISTON PIN	2	
4	MIU14328	PISTON	2	SUB FOR M119153; STD
4	M119174	PISTON	2	0.50 mm, OS
5	M147310	BOLT	2	
6	MIA11872	CONNECTING ROD	2	
7	M77843	SHAFT KEY	1	
8	M147309	SPUR GEAR	1	USE WITH MIA10555 AND MIA11873
8	MIU14329	SPUR GEAR	1	MARKED FD750D-NS12
9	MIA11873	CRANKSHAFT	1	ORDER MIA12869
9	MIA12869	CRANKSHAFT	1	

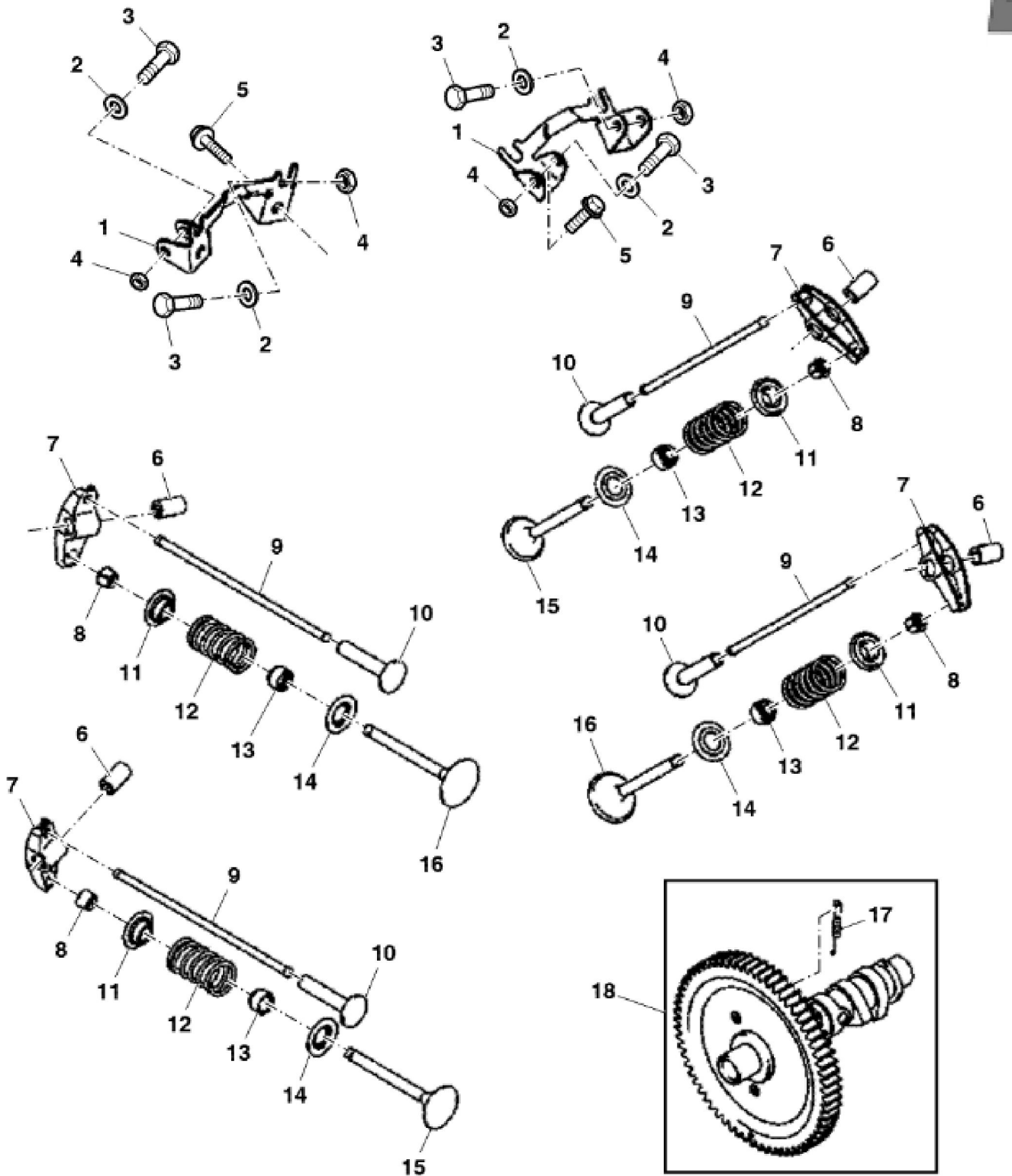

KEY	PART NO.	PART NAME	QTY	REMARKS	
1	M147311	BRACKET	2		
2	M147320	WASHER	4		
3	M147317	BOLT	4		
4	14M7272	NUT	5	M6	
5	M147319	BOLT	4		
6	M147318	BUSHING	4		
7	MIU14434	ROCKER ARM	4	SUB FOR M147314	
8	AM132412	RETAINER	4		
9	M147315	PUSH ROD	4		
10	M70213	TAPPET	4		
11	M72322	WIRE	4		
12	M70206	SPRING	4		
13	M70034	SEAL	4		
14	M70033	SEAT	4	Spring	
15	M147313	EXHAUST VALVE	2	Exhaust	
16	M147312	INTAKE VALVE	2	Intake	
17	M147316	SPRING	1		
18	MIA12870	CAMSHAFT	1	SUB FOR AM132286	

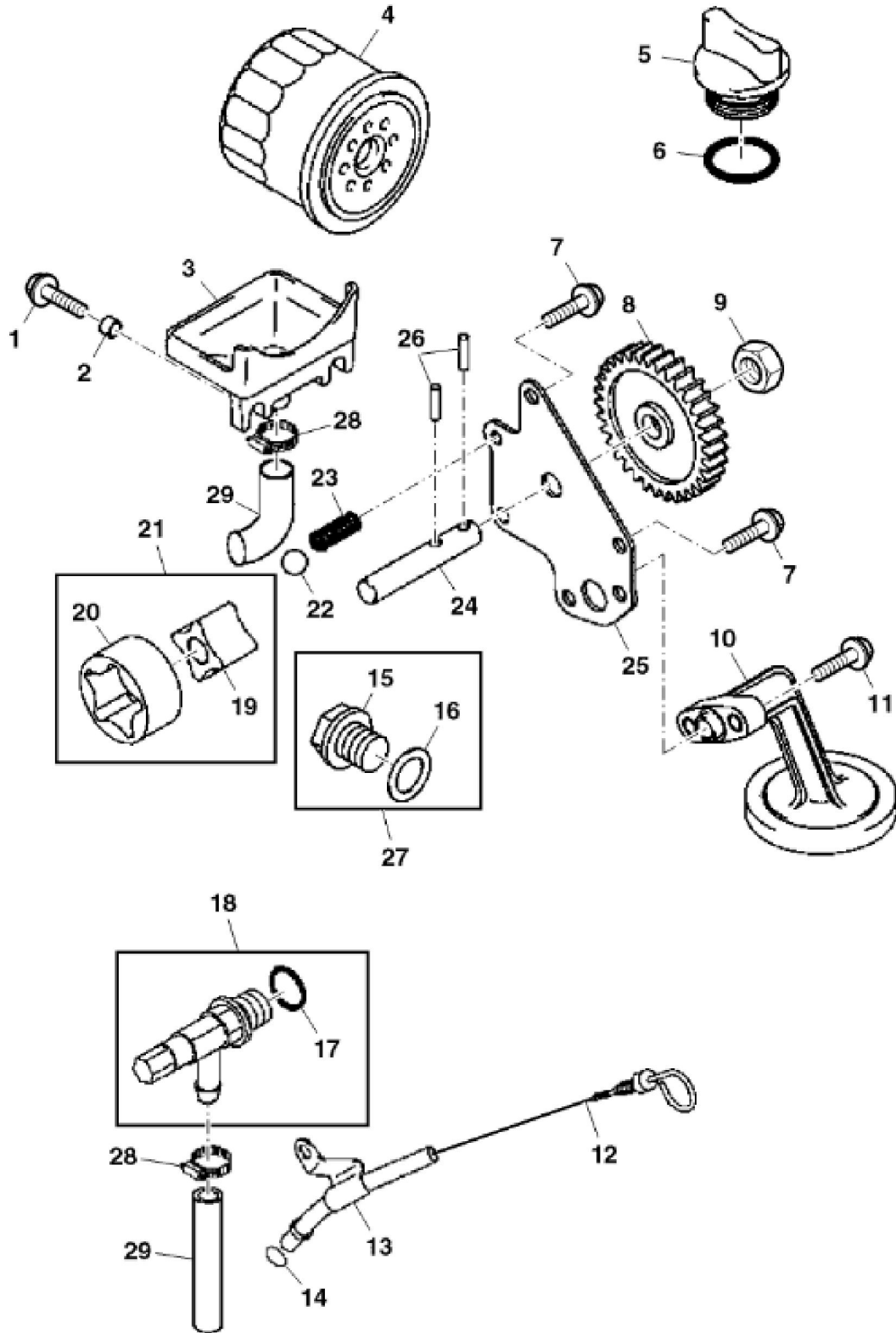

Thank you so much for reading.
Please click the “Buy Now!”
button below to download the
complete manual.



After you pay.

You can download the most
perfect and complete manual in
the world immediately.

Our support email:

ebooklibonline@outlook.com