

# FORD

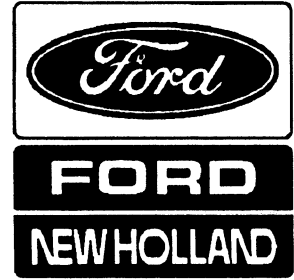

## Operator's Manual

---

Garden Tractor  
LGT 14  
09GN2207

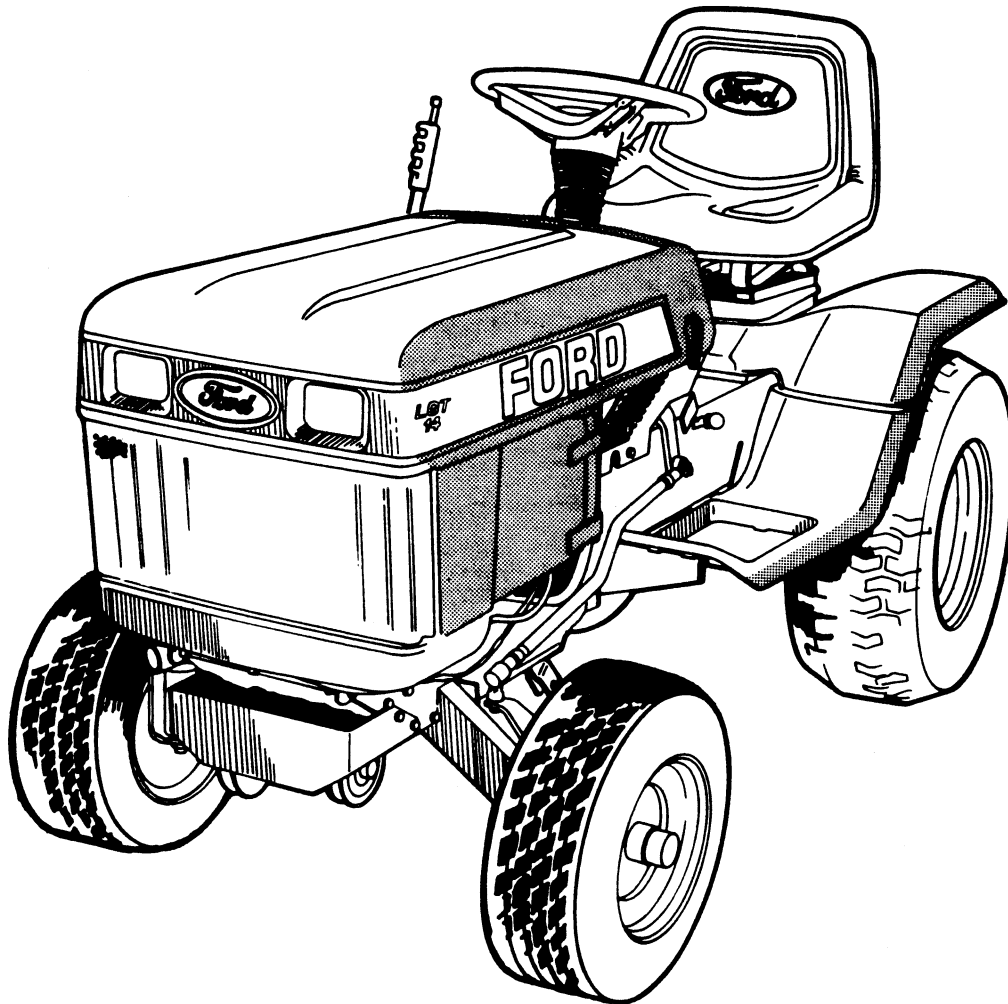

# INTRODUCTION

This operator's manual has been prepared to provide the information you need to correctly assemble, operate and maintain your unit. Read it carefully and keep it for future reference. Should you ever need repair parts or service, contact your authorized parts and service dealer.

Be sure safety precautions are observed. Read and follow all safety and operating instructions in this operator's manual.

Any references made in this manual concerning the right- or left-hand sides are determined with the operator facing forward in the operating position.

The replacement of any part on this product by other than the manufacturer's authorized replacement part may adversely affect the performance, durability or safety of this product.

The manufacturer reserves the right to make changes on, or add improvements to its product at any time without prior notice or obligation. The manufacturer also reserves the right to decide, upon its discretion and at any time, to discontinue a product.

**NOTICE:** A decal with the product model number and serial number of your unit is on the left side of the tractor frame/engine base assembly. Record these numbers in the spaces provided below. Engine model, type and code numbers are located on the engine blower housing, cylinder head shield or backplate.

Product Model No. \_\_\_\_\_

Product Serial No. \_\_\_\_\_

Engine Model No. \_\_\_\_\_

Engine Type No. \_\_\_\_\_

Engine Code No. \_\_\_\_\_

Dealer Purchased From \_\_\_\_\_

Date Purchased \_\_\_\_\_

Dealer Address \_\_\_\_\_

\_\_\_\_\_

Dealer Telephone No. \_\_\_\_\_

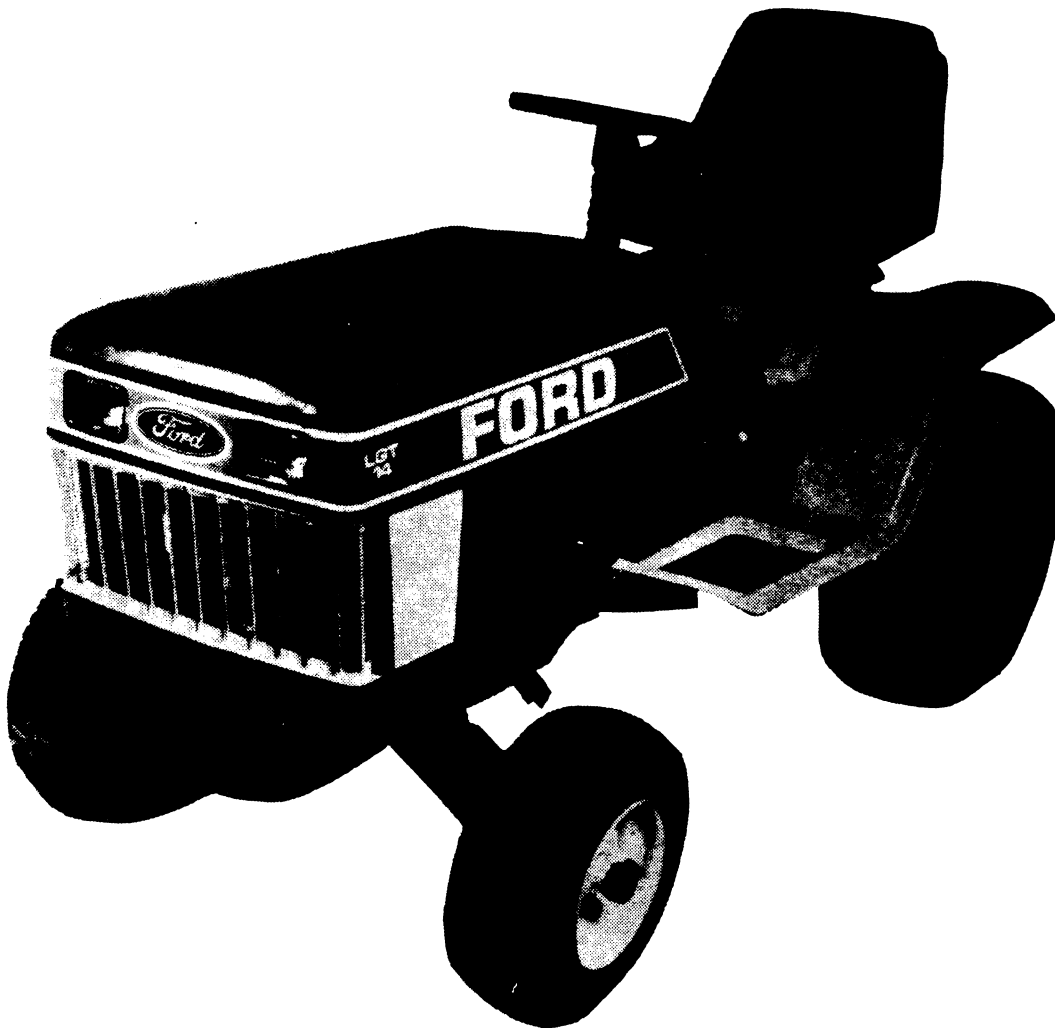

# TABLE OF CONTENTS

<b>1 Safety Precautions</b> .....	1.1-1.4	<b>6 Electrical System</b>	
<b>Controls And Operation</b>		Battery-Electrolyte Level .....	6.1
Brake Clutch Pedal .....	2.1	Cleaning The Battery .....	6.1
Gear Shift Lever .....	2.1	Fuse .....	6.1
Choke Control .....	2.2	Safety Interlock System .....	6.1
Engine Speed Control .....	2.2	<b>7 Storage</b> .....	7.1
P.T.O. (Power Take-Off) Switch .....	2.2	<b>8 Trouble Shooting</b> .....	8.1
P.T.O. Warning Light .....	2.2	<b>9 Wiring Diagram</b> .....	9.1
Headlight Switch .....	2.2	<b>10 Replacement Decals</b>	
Ignition Switch .....	2.2	Safety .....	10.1
Seat Adjuster Handle .....	2.2	Standard .....	10.1
Parking Brake Latch .....	2.3	<b>11 Set-Up And Assembly</b>	
Attachment Lift Lever .....	2.3	Hardware Bag Contents .....	11.1
Ammeter .....	2.3	Battery .....	11.2
<b>3 Trial Run</b> .....	3.1	Steering Wheel .....	11.3
<b>4 Maintenance And Lubrication</b>		Seat .....	11.4
Tune-Up Specifications .....	4.1	Initial Servicing .....	11.5
Break-In Maintenance And Lubrication .....	4.1	<b>12 Parts And Parts List</b> .....	12.1-12.15
Daily Schedule .....	4.1		
25 Hour Schedule .....	4.2		
50 Hour Schedule .....	4.3		
100 Hour Schedule .....	4.3		
<b>5 Adjustment And Servicing</b>			
Traction Belt .....	5.1		
Belt Diagram .....	5.2		
Brake Pad .....	5.3		
Electrical P.T.O. Clutch .....	5.4		

**IMPORTANT: IF SAFETY OR STANDARD Decals are missing, illegible, or damaged, they should be replaced. See "Replacement Decals" section.**

Notice to Customers in the State of California-The engine on this unit is **NOT** equipped with a spark arresting muffler.

## IMPORTANT

**USE OR OPERATION OF THIS ENGINE ON ANY FOREST COVERED, BRUSH COVERED, OR GRASS COVERED LAND WITHOUT A STATE APPROVED SPARK ARRESTER IN EFFECTIVE WORKING ORDER BY THE OPERATOR CONSTITUTES A VIOLATION OF THE LAW OF THE STATE OF CALIFORNIA, OTHER STATES MAY HAVE SIMILAR LAWS. FEDERAL LAWS APPLY ON FEDERAL LANDS.**

# 1 SAFETY PRECAUTIONS

THE FOLLOWING PRECAUTIONS ARE SUGGESTED TO HELP PREVENT ACCIDENTS.

**A CAREFUL OPERATOR IS THE BEST OPERATOR. MOST ACCIDENTS CAN BE AVOIDED BY OBSERVING CERTAIN PRECAUTIONS. READ AND TAKE THE FOLLOWING PRECAUTIONS BEFORE OPERATING THIS TRACTOR TO HELP PREVENT ACCIDENTS. EQUIPMENT SHOULD BE OPERATED ONLY BY THOSE WHO ARE RESPONSIBLE AND INSTRUCTED TO DO SO.**

## THE TRACTOR

- Know the controls and how to stop quickly. READ THIS OPERATOR'S MANUAL and instructions furnished with attachments.
- Do not modify or alter or permit anyone else to modify or alter this tractor or any of its components or any tractor function.
- Do not allow children to operate the vehicle. Do not allow adults to operate it without proper instruction.
- Do not carry passengers. Do not mow when children and others are around. There is no safe place for extra riders.
- Keep all shields in place.
- Replace safety and warning decals when they become illegible.

## FUEL USAGE SAFETY

- Handle gasoline with care. It is highly flammable. Only use approved gasoline container.
- Do not attempt to fill gas tank from fuel container unless the container spout or funnel fits inside the fuel tank filler neck. The use of too large a spout or funnel, or no funnel, may result in spilled gasoline, creating highly flammable gas vapors. This could result in fire and/or explosion, causing severe bodily injury.
- Never take the cap off or refuel when the engine is running or hot.
- Don't smoke while refueling or anywhere near fuel.
- Do not store, spill or use gasoline near an open flame.
- When filling the tank, maintain control of the nozzle.
- Don't fill fuel tank to capacity...allow room for expansion.
- Wipe up any spills immediately.
- Always tighten the fuel tank cap securely.
- If the original equipment fuel tank cap is lost, always replace it with an approved cap. A will-fit cap may not be safe.
- Don't drive equipment near open fire.
- Never use gasoline for cleaning parts.

## TRACTOR OPERATION

- Disengage all power to attachment(s), fully depress brake-clutch pedal and shift into neutral before attempting to start the engine.
- Only use jumper cables in recommended manner as outlined in Operator's Manual.
- Do not bypass the safety interlock system. Consult your Dealer if your safety controls malfunction.
- Reduce speed and exercise extreme caution on slopes and in sharp turns to prevent tipping or loss of control. Be especially cautious when changing direction on slopes.

- Except for adjustment do not operate engine if air cleaner or cover directly over carburetor air intake is removed. Removal of such part could create a fire hazard.
- Do not operate without a muffler or tamper with the exhaust system. Damaged mufflers or spark arresters could create a fire hazard. Inspect periodically and replace if necessary.
- Do not operate the tractor engine in an enclosed building without adequate ventilation. Exhaust fumes can cause death.
- Do not start the engine or operate controls while standing beside the tractor. Always sit in the tractor seat when starting the engine or operating controls.
- Do not get off the tractor while it is in motion.
- Before leaving the operator's position, disengage power to attachment(s), lower the attachments, shift into neutral, set the parking brake and stop the engine and remove key (if so equipped).
- Never leave the unit when it is parked on an incline. Always park the unit on level ground where possible. If the unit is to be parked on an incline, always lower the attachment(s), set the parking brake, and securely block the wheels.
- Drive the tractor with care and at speeds compatible with safety, especially when operating over rough ground, crossing ditches, slopes and when turning to avoid upsets.
- When using any attachments, never direct discharge of material toward bystanders nor allow anyone near the vehicle while in operation.
- Keep people and pets a safe distance away from machine.
- Disengage power to attachment(s) when transporting or not in use.
- Keep the tractor in the same gear when going downhill as used when going uphill. Do not coast or free wheel down hills.
- Use care when pulling loads or using heavy equipment.
  - a) Use only approved drawbar hitch points.
  - b) Limit loads to those you can safely control.
  - c) Do not turn sharply. Use care when backing.
  - d) Use counterweight(s) or wheel weights when suggested in the operator's manual.
- Watch out for traffic when crossing or near roadways.
- It is recommended that this machine not be used on public roads. However, if riding on public roads is unavoidable you must comply to equipment requirements per SAE J137b and/or ASAE S279.4 lighting and marking standard. These standards require vehicles be equipped with two (2) headlights, one (1) red taillight, two (2) amber flashing warning lights and a slow moving vehicle (SMV) emblem for operation on public roads.

## MOWER OPERATION

- Clear the work area of objects which might be picked up and thrown.
  - When using the vehicle with mower, proceed as follows:
    - a) Mow only in daylight or in good artificial light.
    - b) Never make a cutting height adjustment while the engine is running if the operator must dismount to do so.
    - c) Check the blade mounting bolts for proper tightness at frequent intervals.
    - d) Shut the engine off when removing the grass catcher or unclogging chute.
- Watch for holes, rocks and roots in the terrain and other hidden hazards. Keep away from drop-offs.
- Do not stop or start suddenly when going uphill or downhill. Mow up and down the face of steep slopes; never across the face.
- Disengage power to mower before backing up. Do not mow in reverse unless absolutely necessary and then only after careful observation of the entire area behind the mower.

## SERVICING, MAINTENANCE AND STORAGE

- The vehicle and attachments should be stopped and inspected for damage after striking a foreign object and the damage should be repaired before restarting and operating the equipment.
- Keep the vehicle and attachments in good operating condition and keep safety devices in place and in working condition.

- Keep open flame away from battery or cold weather starting aids to prevent fires or explosions.
- Disengage power to attachment(s), stop the engine, disconnect spark plug wire(s) from spark plug(s) before cleaning and making any repairs or adjustments.
- Do not lubricate or make mechanical adjustments while the unit is in motion or when the engine is running. However, if minor engine adjustments must be made, set the parking brake, securely block the wheels and use extreme caution.
- It is necessary to adjust the carburetor with the engine running, take extra care not to allow rings, wristwatches, clothing, etc. to become entangled with moving parts.
- Do not strike flywheel with a hard object or metal tool as this may cause flywheel to shatter in operation, causing personal injury or property damage.
- Do not change the engine governor setting or over-speed the engine.
- To reduce fire hazard, keep the engine free of grass, leaves, or excessive grease. Do not clean while engine is running.
- Keep all nuts, bolts and screws tight to be sure the equipment is in safe working condition.
- Never store equipment with gasoline in the tank inside a building where fumes may reach an open flame or spark. Allow the engine to cool before storing in any enclosure.
- Keep the machine and supply of gasoline in locked storage to prevent children or others from playing or tampering with them. When machine is to be stored for an extended time, disconnect battery cables or remove the battery.
- Under normal usage the grass catcher bag material is subject to deterioration and wear. Check bag frequently for deterioration and wear and replace worn bags. Check that replacement bags comply with the original manufacturer's recommendations or specifications.

## SAFETY DEFINITIONS

 **DANGER**

The signal word "DANGER" signifies that a source of extreme danger to a person on or near a machine exists as a result of the very nature of the machine itself. This danger to persons is such that it would result in a high likelihood of death or permanent injury if the recommended precautions are not taken.

 **WARNING**

The signal word "WARNING" indicates that a source of danger to a person on or near a machine exists which may result in death or injury if the recommended precautions are not taken.

When you see this symbol  it means: ATTENTION! BECOME ALERT! YOUR SAFETY IS INVOLVED!

## SAFETY PRECAUTIONS

Safety is **NO** accident ..... Be Alert!

This symbol is used to attract your attention to the safety precautions that should be understood by the operator to avoid accidents.



When you see this symbol-HEED ITS WARNING!



- Be sure to read all tractor and engine instructions before operating.



- Improper use of the tractor can result in injury. Give complete and undivided attention to the work you are doing.
- Know your controls. Know how to stop tractor and engine in an emergency.

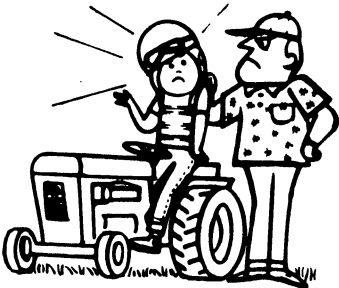

- Do not allow children to operate tractor. Anyone else should be properly instructed as to its operation.
- Keep children and pets away. Children and pets should be kept a good safe distance away from mower.
- Stop operation when another person approaches.



- Reduce speed on all side slopes and sharp turns to prevent tipping or losing control.



- Do not allow anyone to ride on tractor or any of its attachments.

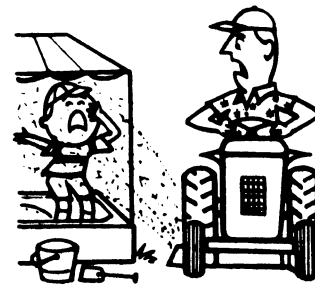

- Never allow tractor to discharge grass toward anyone.



- All guards must be in place before operating tractor.

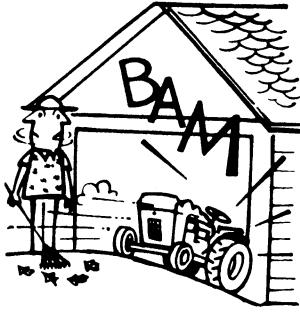

- Set parking brake and stop engine before leaving seat.



- Be sure lawn is clean. Remove stones, wires, sticks, toys anything that might catch or be thrown by the mower blade.

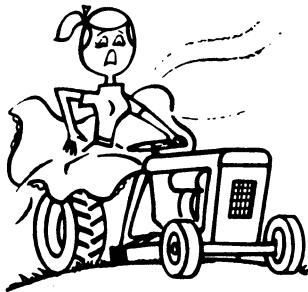

- Do not wear loose fitting clothing that might get caught in moving parts. Also, keep hands and feet away from moving parts.



- Stop engine and disconnect spark plug wire before working on mower. Stop engine before cleaning discharge chute or making any adjustments, inspection or repairs. Disconnect spark plug wire to prevent accidental starting.

- Periodically maintain mower. Tighten nuts, bolts and fittings periodically and lubricate mower for proper and safe operation. Check blade for tightness.



- Store gasoline safely. Store gasoline in an approved tightly sealed container. Refuel outdoors and only with engine stopped. Do not spill gasoline on a hot engine.



- Do not operate mower in a confined area. Exhaust fumes are dangerous. Only run engine out of doors.



- Disengage all clutches and place gear shift in neutral before attempting to start engine.
- The discharge guard must be down at all times during mowing operation.
- If mower strikes a foreign object, stop the mower and engine immediately. Remove spark plug wire and inspect the mower for damage. Repair any damage before starting again.

## 2 CONTROLS AND OPERATION

Refer to Fig. 2.1A.

**IMPORTANT:** Be sure to read this section of the Operator's Manual before you attempt to operate your tractor. It is for your safety that you know where all controls are, and are familiar with the functions of each control.

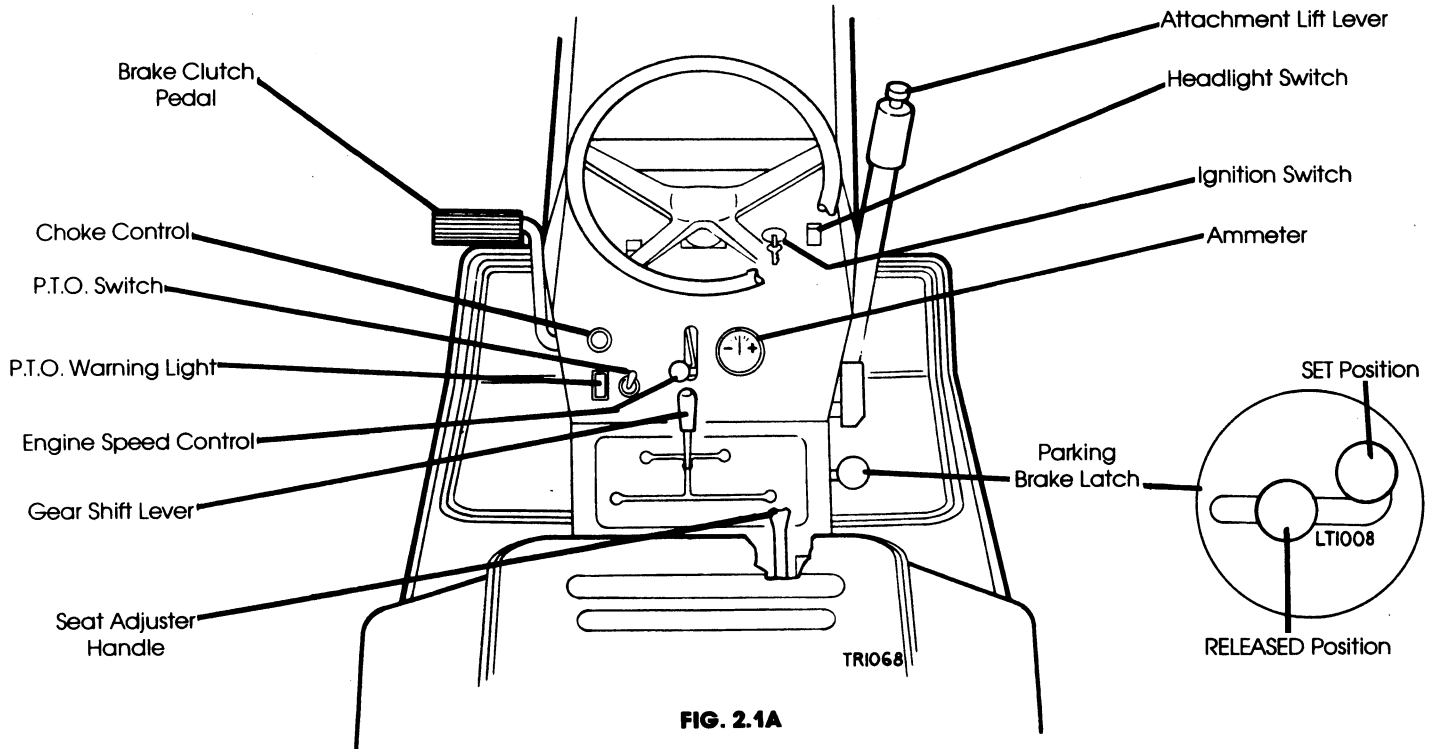

FIG. 2.1A

### SAFETY INTERLOCK SYSTEM

Your tractor is equipped with an interlock system that will allow the engine to start only if the brake clutch pedal is fully depressed, the P.T.O. is in the OFF position, and the operator is properly seated. Refer to ELECTRICAL SYSTEM section ("Safety Interlock System") for further explanation.

### BRAKE CLUTCH PEDAL

Depressing this brake clutch pedal applies the brake and at the same time disengages the drive.

**To operate:** Depress brake clutch pedal fully for starting, braking and changing gears. Remove foot slowly and completely from brake clutch pedal to engage drive.

**NOTE:** The brake clutch pedal must be completely depressed, and the P.T.O. must be in the OFF position, before the engine can be started.

### GEAR SHIFT LEVER

This lever controls the ground speed (4 speeds forward and 1 reverse).

The tractor was designed to start out in any gear. The gear should be chosen to suit the terrain and the needs of the attachment being used.

Change gears only with unit at full stop and brake clutch pedal fully depressed.

**IMPORTANT:** To avoid damaging transmission, never shift in motion.

Always place gear shift lever in neutral N before starting engine.

Fully depress brake clutch pedal, and then move shift lever to the desired gear position (1 or 4 for progressively faster forward movement, R for reverse). Slowly release brake clutch pedal to initiate tractor movement.

**NOTE:** The 1st gear is primarily used for slow ground working conditions. The tractor is equipped with a 1st gear lock out, used for normal tractor operations. When 1st gear is desired, flip the lock out plate up and shift into 1st gear.



Thank you so much for reading.  
Please click the “Buy Now!”  
button below to download the  
complete manual.



After you pay.

You can download the most  
perfect and complete manual in  
the world immediately.

Our support email:

[ebooklibonline@outlook.com](mailto:ebooklibonline@outlook.com)