

FORD

1920 TRACTOR

42192010



OPERATOR'S MANUAL

Reprinted



F1158

PLEASE READ CAREFULLY :

For a complete list of the pre-delivery service checks performed by your dealer, refer to PRE-DELIVERY SERVICE on the upper portion of page 69 and 71. The copy on page 69 is your record of the service performed and the copy on page 71, which is to be removed from the manual, is your dealer's. MAKE SURE THAT YOU AND THE DEALER SIGN BOTH COPIES.

After you have operated your tractor for fifty hours, take this manual and your tractor to your dealer. He will then perform the factory recommended 50-HOUR SERVICE as listed on the lower portions of pages 69 and 71 – without charge – except for lubricant, oil, or filters replaced as part of normal maintenance. MAKE SURE THAT YOU AND THE DEALER SIGN BOTH COPIES.

A PRODUCT IDENTIFICATION PLATE is located on the left-hand side of the transmission housing. The numbers on the plate are important should your tractor require future service. For your convenience, have your dealer record the numbers in the appropriate spaces below.

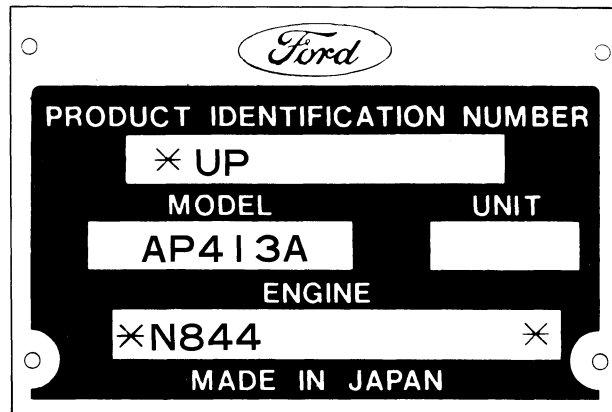

The top illustration shows a Ford Product Identification Plate. At the top center is the Ford logo. Below it, the text "PRODUCT IDENTIFICATION NUMBER" is printed. Underneath, there are four rows of information: 1. A box containing "× UP". 2. Two boxes: "MODEL" containing "AP413A" and "UNIT" which is empty. 3. A box containing "ENGINE" with "×N844" written below it, and a "×" symbol to the right. 4. A box containing "MADE IN JAPAN".

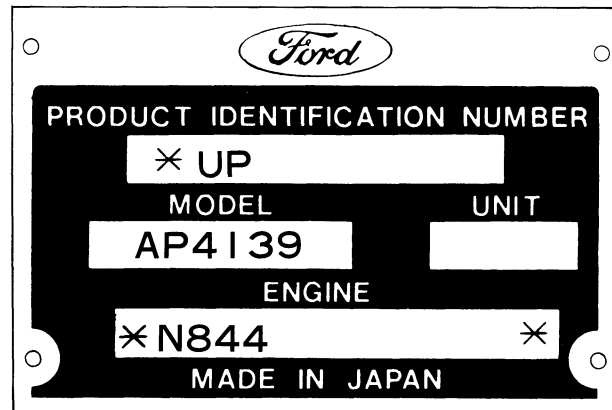

The bottom illustration shows a second Ford Product Identification Plate, identical in layout to the top one. It contains the following information: 1. A box containing "× UP". 2. Two boxes: "MODEL" containing "AP4139" and "UNIT" which is empty. 3. A box containing "ENGINE" with "×N844" written below it, and a "×" symbol to the right. 4. A box containing "MADE IN JAPAN".

Ford New Holland policy is one of continuous improvement, and the right to change prices, specification or equipment at any time without notice is reserved.

All data given in this book is subject to production variations. Dimensions and weights are approximate only and the illustrations do not necessarily show tractors in standard condition. For exact information about any particular tractor please consult your Ford New Holland Dealer..

CONTENTS

INTERNATIONAL SYMBOLS	3
SAFETY PRECAUTIONS	4-5
CONTROLS AND INSTRUMENTS	6-13
SEAT, SEAT BELT AND ROPS	6
LIGHTING	7
INSTRUMENT PANEL	7-9
THROTTLE CONTROLS	9
BRAKE CONTROLS	10
DIFFERENTIAL CONTROL	10
TRANSMISSION AND PTO CONTROLS	10-12
HYDRAULIC LIFT SYSTEM CONTROLS	12-13
OPERATION	14-31
BREAK-IN PROCEDURES	14
STARTING THE ENGINE	14-15
STOPPING THE ENGINE	15
OPERATING THE TRANSMISSION, FOUR-WHEEL DRIVE AND PTO	15-18
TOWING THE TRACTOR	18
OPERATING THE DIFFERENTIAL LOCK	18-19
OPERATING THE HYDRAULIC LIFT SYSTEM	19-22
DRIVING THE TRACTOR	22-24
WHEEL TREAD SETTINGS	24-27
TRACTOR WEIGHTING	28-29
TIRE PRESSURES	30-31
LUBRICATION AND MAINTENANCE	32-55
LUBRICATION AND MAINTENANCE CHART	32-33
TWO-WHEEL DRIVE	32
FOUR-WHEEL DRIVE	33
FUEL AND LUBRICANTS	34-37
FUEL AND LUBRICANT SERVICE PROCEDURES	37-42
GENERAL MAINTENANCE	42-53
TRACTOR STORAGE	53-54
GENERAL TORQUE SPECIFICATION TABLE	55
SPECIFICATIONS	56-60
SAFETY AND INSTRUCTION DECALS	61-66
PREDELIVERY AND 50-HOUR SERVICE	69-71

INTERNATIONAL SYMBOLS

As a guide to the operation of your tractor, various international symbols have been utilized on the instruments and controls. The symbols are shown below with an indication of their meaning.

	Engine speed		Glow		Control lever operating direction
	Hours recorded		Engine stop		Rock shaft (raised)
	Engine water temperature		Engine oil		Rock shaft (lowered)
	Air filter		Parking brake		Remote cylinder (float)
	Engine oil pressure		Lights (upper beam)		Remote cylinder (retracted)
	Hazard warning		Lights (lower beam)		Remote cylinder (extended)
	Axle connect		Lock		Forward
	Axle disconnect		Release lock		Warning! contains asbestos
	Continuously variable		Up		
	Increase		Down		
	Decrease		Differential lock		
	Fuel level		Read operator's manual		
	Creeper range		Battery		
	High range		Power take-off (on)		
	Middle range		Power take-off (off)		
	Low range		"Tortoise," slow or minimum setting		
	Neutral		"Hare," fast or maximum setting		
	Diesel fuel		Warning		

F1001

SAFETY PRECAUTIONS

The following precautions are suggested to help prevent accidents.

A careful operator is the best operator. Most accidents can be avoided by observing certain precautions. Read and take the following precautions before operating this tractor to help prevent accidents. Equipment should be operated only by those who are responsible and instructed to do so.

THE TRACTOR

1. Read the Operator's Manual carefully before using the tractor. Lack of operating knowledge can lead to accidents.
2. Use an approved Rollbar and Seat Belt for safe operation. Overturning a tractor without a rollbar can result in death or injury. If your tractor is not equipped with a rollbar and seat belt, see your Ford New Holland Dealer.
3. Always use the seat belt. Do not use the seat belt if the rollbar has been removed from the tractor.
4. If a front end loader is to be installed, always use a FOPS canopy to avoid injury from falling objects.
5. Use the handholds and step plates when getting on and off the tractor to prevent falls. Keep steps and platform cleared of mud and debris.
6. Do not permit anyone but the operator to ride on the tractor. There is no safe place for extra riders.
7. Replace all missing, illegible, or damaged safety decals. See list of decals on page 61.
8. Keep safety decals clean of dirt and grime.

SERVICING THE TRACTOR

1. The cooling system operates under pressure which is controlled by the radiator cap. It is dangerous to remove the cap while system is hot. Always turn cap slowly to the first stop and allow the pressure to escape before removing the cap entirely.
2. Do not smoke while refueling the tractor. Keep any type of open flame away. Wait for engine to cool before refueling.
3. Keep the tractor and equipment, particularly brakes and steering, maintained in a reliable and satisfactory condition to ensure your safety and comply with legal requirements.
4. Keep open flame away from battery or cold weather starting aids to prevent fires or explosions. Use jumper cables according to instructions to prevent sparks which could cause explosion.
5. Stop the engine before performing any service on the tractor.
6. Escaping hydraulic/diesel fluid under pressure can penetrate the skin causing serious injury.
 - **DO NOT** use your hand to check for leaks. Use a piece of cardboard or paper to search for leaks.
 - Stop engine and relieve pressure before connecting or disconnecting lines.
 - Tighten all connections before starting engine or pressurizing lines.

If fluid is injected into the skin obtain medical attention immediately or gangrene may result.

7. Do not modify or alter or permit anyone else to modify or alter this tractor or any of its components or any tractor function

without first consulting a Ford New Holland Dealer.

8. The fuel oil in the injection system is under high pressure and can penetrate the skin. Unqualified persons should not remove or attempt to adjust a pump, injector, nozzle or any other part of the fuel injection system. Failure to follow these instructions can result in serious injury.
9. Continuous long term contact with used engine oil may cause skin cancer. Avoid prolonged contact with used engine oil. Wash skin promptly with soap and water.
10. Some components on your tractor, such as gaskets and friction surfaces (brake linings, clutch linings etc.), may contain asbestos. Breathing asbestos dust is dangerous to your health. You are therefore advised to have any maintenance or repair operations on such components carried out by an authorized Ford New Holland Dealer. If, however, service operations are to be undertaken on parts that contain asbestos, the essential precautions listed below must be observed:
 - Work out of doors or in a well ventilated area.
 - Dust found on the tractor or produced during work on the tractor should be removed by extraction not by blowing.
 - Dust waste should be dampened, placed in a sealed container and marked to ensure safe disposal.
 - If any cutting, drilling, etc., is attempted on materials containing asbestos, the item should be dampened and only hand tools or low speed power tools used.

OPERATING THE TRACTOR

1. Apply the parking brake, place the P.T.O. lever in the "OFF" position, the lift control lever in the down position, the remote control valve levers in the neutral position, and the transmission in neutral before starting the tractor.
2. Do not start the engine or operate controls while standing beside the tractor. Always sit in the tractor seat when starting the engine or operating controls.
3. Do not bypass the neutral start switches. Consult your Ford New Holland Dealer if your neutral start controls malfunction. Use jumper cables only in the recommended manner. Improper use can result in tractor runaway.
4. Avoid accidental contact with the gear shift levers while the engine is running. Unexpected tractor movement can result from such contact.
5. Do not get off the tractor while it is in motion.
6. Disengage PTO, shut off the engine and apply the parking brake before getting off the tractor.
7. Do not park the tractor on a steep incline.
8. Do not operate the tractor engine in an enclosed building without adequate ventilation. Exhaust fumes can cause death.
9. If power steering or engine ceases operating, stop the tractor immediately.
10. Pull only from the drawbar or the lower link drawbar in the down position. Use only a drawbar pin that locks in place. Pulling from the tractor rear axle or any point above the axle may cause the tractor to upset.

(cont.)

SAFETY PRECAUTIONS (Continued)

11. If the front end of the tractor tends to rise when heavy implements are attached to the three-point hitch, install front end or front wheel weights. Do not operate the tractor with a light front end.
12. Always set the hydraulic selector lever in position control when attaching equipment and when transporting equipment. Be sure hydraulic couplers are properly mounted and will disconnect safely in case of accidental detachment of implement.
13. Do not leave equipment in the raised position.
14. Use the Flasher/Turn Signal Lights and SMV signs when traveling on public roads both day and night unless prohibited by law.
15. Be sure tractor lights are adjusted to prevent blinding an oncoming vehicle operator.

DRIVING THE TRACTOR

1. Watch where you are going especially at row ends, on roads, around trees and low hanging obstacles.
2. To avoid upsets drive the tractor with care and at speeds compatible with safety, especially when operating over rough ground, when crossing ditches or slopes, and when turning corners.
3. Lock tractor brake pedals together when transporting on roads to provide two wheel braking.
4. Keep the tractor in the same gear when going downhill as used when going uphill. Do not coast or free wheel down hills.
5. Any towed vehicle whose total weight exceeds that of the towing tractor must be equipped with brakes for safe operation.
6. When the tractor is stuck or tires are frozen to the ground, back up the tractor to prevent upset.
7. Always check overhead clearance, especially when transporting the tractor.
8. When operating at night, adjust lights to prevent blinding an oncoming driver.

OPERATING THE P.T.O.

1. When operating P.T.O. driven equipment, shut off the engine and wait until the P.T.O. stops before getting off the tractor and disconnecting the equipment.
2. Do not wear loose clothing when operating the power take-off, or when near rotating equipment.
3. When operating stationary P.T.O. driven equipment, always place both gear shift levers in neutral, apply the tractor parking brake and block the rear wheels front and back.

4. To avoid injury, do not clean, adjust, unclog or service P.T.O. driven equipment when the tractor engine is running.
5. Make sure the P.T.O. master shield is installed at all times and always replace the P.T.O. shield cap when the P.T.O. is not in use.

DIESEL FUEL

1. Under no circumstances should gasoline, alcohol or blended fuels be added to diesel fuel. These combinations can create an increased fire or explosive hazard. Such blends are more explosive than pure gasoline in a closed container such as a fuel tank. **Do not use these blends.**
2. Never remove the fuel cap or refuel with the engine running or hot.
3. Do not smoke while refueling or when standing near fuel.
4. Maintain control of the fuel filler pipe nozzle when filling the tank.
5. Do not fill the fuel tank to capacity. Allow room for expansion.
6. Wipe up spilled fuel immediately.
7. Always tighten the fuel tank cap securely.
8. If the original fuel tank cap is lost, replace it with a Ford approved cap. A non-approved, proprietary cap may not be safe.
9. Keep equipment clean and properly maintained.
10. Do not drive equipment near open fires.
11. Never use fuel for cleaning purposes.
12. Arrange fuel purchases so that winter grade fuels are not held over and used in the spring.

SAFETY FRAME (ROPS)

If your Ford Tractor is equipped with a safety frame it must be maintained in a serviceable condition. Be careful when driving through doorways or working in confined spaces with low headroom.

Under no circumstances :

1.modify, drill or alter the safety frame in any way as doing so could render you liable to legal prosecution.
2.attempt to straighten or weld any part of the main frame or retaining brackets which have suffered damage. By doing so you may weaken the structure and endanger your safety.
3.secure any parts on the main frame or attach your safety frame with other than the special high tensile bolts and nuts specified.
4.attach chains or ropes to the main frame for pulling purposes.
5.take unnecessary risks even though your safety frame affords you the maximum protection possible.

When you see this symbol



it means:

ATTENTION BECOME ALERT! YOUR SAFETY IS INVOLVED!

CONTROLS AND INSTRUMENTS

SEAT, SEAT BELT AND ROPS

TRACTOR SEAT

Your Ford 1920 Tractor is equipped with a suspension seat as shown in Figure 1. The seat is adjustable to obtain the most comfortable position.

To move the seat fore and aft, move the seat release lever to the side and slide the seat fore or aft as desired, Figure 2.

To adjust the seat for flotation, turn the flotation adjusting bolt right for a firm ride, or left for a soft ride, Figure 2.

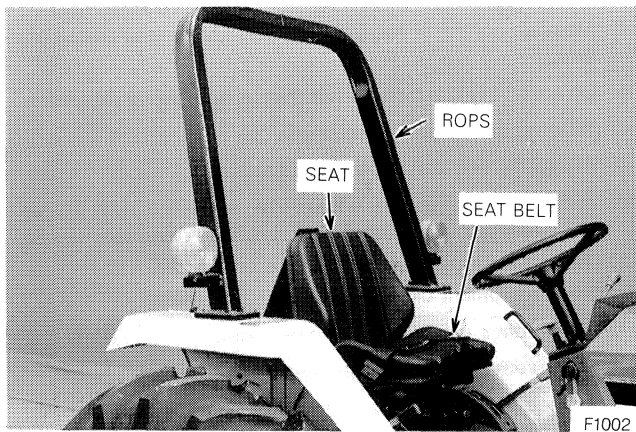

Figure 1 – Tractor Seat, ROPS and Seat Belt

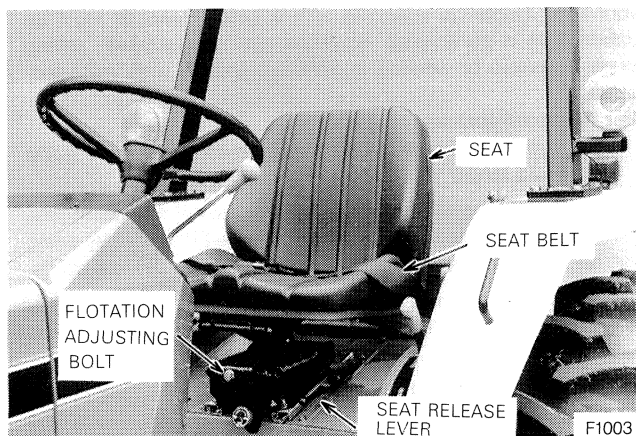

Figure 2 – Tractor Seat Adjustment

ROLLOVER PROTECTIVE STRUCTURE (ROPS)

A Roll Over Protective Structure (ROPS) and seat belts were standard equipment for this tractor at

time of factory assembly. If the ROPS was deleted by the original purchaser or has been removed, it is recommended that you equip your tractor with a Roll Over Protective Structure (ROPS) and seat belts. ROPS are effective in reducing injuries during tractor overturn accidents. Overturning tractor without a ROPS can result in serious injury or death.

Roll Over Protective Structure (ROPS), and seat belts are available from your Ford New Holland Dealer.

The safety offered by the roll bar and seat belt is minimized if your seat belt is not buckled. Always use your seat belt — they save lives.



WARNING: Always wear the seat belt when the tractor is equipped with a ROPS. DO NOT use the seat belt if the ROPS is removed from the tractor.



WARNING: DO NOT attach chains or ropes to the roll bar for pulling purposes since the tractor can tip backward. Always pull from the tractor drawbar. Be careful when driving through door openings or under low overhead objects. Make sure there is sufficient overhead clearance for the roll bar.

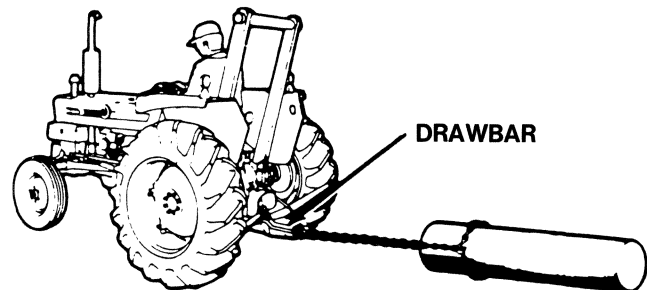

ADJUSTING THE SEAT BELT

To lengthen the belt, tip the buckle end down and pull on the buckle until the ends can be joined.

To shorten the belt, buckle it, then pull on the loose end until the belt is snug.

If the seat belt is to be cleaned, use soap and water. Do not use carbon tetrachloride, naphtha, etc., as these will weaken the webbing. For the same reason, do not bleach or redye the webbing. Replace seat belt if worn or damaged.

CONTROLS AND INSTRUMENTS

LIGHTING

FLASHER WARNING LAMP

Your Ford tractor is equipped with flasher warning lamps, Figure 3. The switch, Figure 4 for the warning lamps is located on the instrument panel.

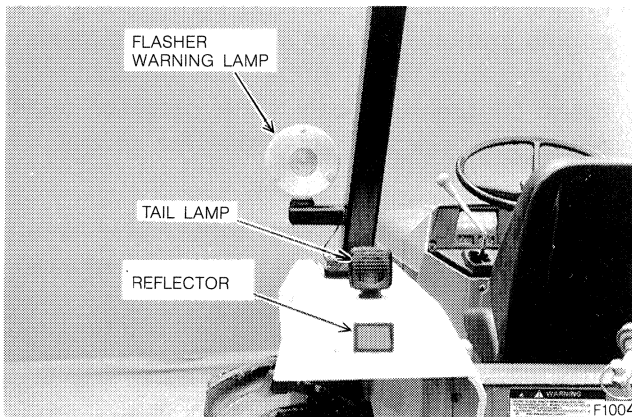

Figure 3 – Flasher Warning and Tail Lamp

The light switch must be turned in one of the "ON" positions before the flasher will operate.

For your protection, use the flasher warning lamp and the SMV emblem when traveling on public roads, day or night.

LIGHT SWITCH

The light switch, shown in Figure 4, is a dial type switch. Its positions are :

- 1st Position "OFF"
- 2nd position Headlights (High Beam),
and Tail Lamp "ON"
- 3rd position Headlights (Low Beam),
and Tail Lamp "ON"

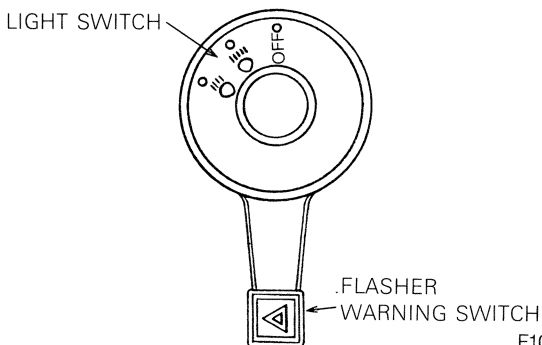

Figure 4 – Combination Switch

INSTRUMENT PANEL

KEY SWITCH

The key switch is shown in Figure 5. Turning the key to the left will activate the cold-start aid. Turning the key to the right to the "on" position will activate the warning lights and instruments. Turning the key further right to the "start" position will start the engine. Upon release, the key will spring return to the "on" position.

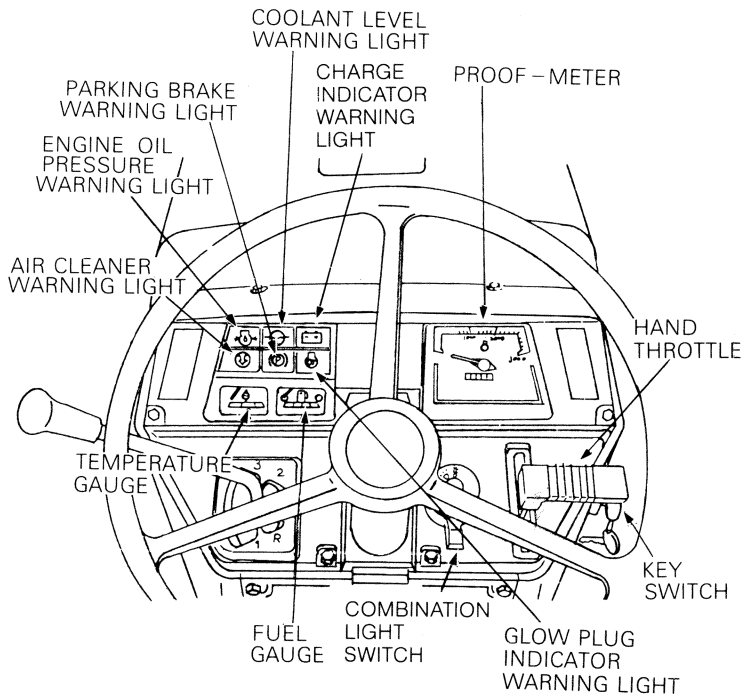

Figure 5 – Instrument Panel

F1006

The starting circuit can only be activated when the main shift lever or shuttle lever (if equipped) and P. T. O. lever are in neutral. Always check to make certain the transmission main shift lever and P. T. O. lever are in neutral before attempting to start the engine. Refer to page 14 for complete starting instructions.

Thank you so much for reading.
Please click the “Buy Now!”
button below to download the
complete manual.



After you pay.

You can download the most
perfect and complete manual in
the world immediately.

Our support email:

ebooklibonline@outlook.com