

NEW HOLLAND
TN55V
TN65V
TN75V
TN65N
TN75N

86620310 9/00
603.64.501.00

OPERATOR'S MANUAL

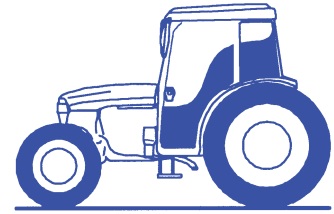

NEW HOLLAND

CALIFORNIA

Proposition 65 Warning

Diesel engine exhaust and some of its constituents are known to the State of California to cause cancer, birth defects, and other reproductive harm.

Battery posts, terminals and related accessories contain lead and lead compounds, chemicals known to the State of California to cause cancer and birth defects or other reproductive harm. Wash hands after handling.

CONTENTS

Section 1

General Information And Safety Measures	1-1
Tractor identification plates	1-2
Important ecological considerations	1-5
Always work safely	1-6
Working safely	1-7
Safety decals	1-13
Standardised symbols	1-18
Tractor noise level information sheet	1-19

Section 2

Controls	2-2
Cab	2-4
Air conditioning system instructions for use	2-12
Air conditioning system	2-13
Cab air conditioning controls	2-14
Seat	2-16
Brakes	2-18
Instrument panel	2-20
Digital control instrument panel	2-21
Operation indicator light panel	2-22
Transmission with range gear, mechanical shuttle and splitter 30/40 km/h (18.64/24.85 mph) - 32F+16R	2-37
Transmission with creeper unit, mechanical shuttle and splitter 30/40 km/h (18.64/24.85 mph) - 44F+16R	2-39
Transmission with electro-hydraulic hi-lo / power-shuttle 30/40 km/h (18.64/24.85 mph) - 32f+ 16r or 44f+16r	2-41
Fast mechanical transmissions 40 km/h (24.85 mph) (four-wheel drive models)	2-47
Electronically controlled hydraulic four-wheel drive	2-53
Differential lock	2-55
Power take-off	2-58
Mechanically controlled hydraulic lift	2-59
Electronically controlled hydraulic lift	2-60

Section 3

Power take-off	3-6
Mechanically controlled hydraulic lift	3-11
Electronically controlled hydraulic lift	3-14
Three-point linkage	3-23

Three point linkage – models TN55V TN65V TN75V	3-27
Three point linkage – models TN65N TN75N	3-28
Rear remote control valves	3-29
Tyres	3-31
Ballasting	3-45
Maximum permitted weights	3-46

Section 4

Lubrication and maintenance	4-1
Tractor refuelling	4-2
Access for inspection and maintenance	4-4
Lubrication and maintenance table	4-5
Flexible maintenance	4-7
When the indicator light illuminates on the dashboard	4-9
Every 10 hours of work	4-11
Every 50 hours of work	4-14
Every 300 hours of work	4-18
Every 900 hours of work	4-24
Every 1200 hours of work or every year	4-25
Every 1200 hours or every 2 years	4-26
General maintenance	4-31
Electrical system	4-37
Calibration	4-47
Fuel and lubrication specifications	4-58

Section 5

Troubleshooting	5-1
-----------------------	-----

Section 6

Prolonged tractor inactivity	6-1
------------------------------------	-----

Section 7

Accessories	7-1
-------------------	-----

Section 8

Specifications	8-1
----------------------	-----

Section 9

Inspections and/or operations to be carried out	9-1
---	-----

Section 10

Index	10-1
-------------	------

SECTION 1

GENERAL INFORMATION AND SAFETY MEASURES

GENERAL GUIDELINES

This Use and Maintenance Manual provides a guide for the user with regard to running-in, use and maintenance of the tractor.

Read this manual carefully and keep in a convenient place for future reference. Do not hesitate to contact your local dealer for any queries concerning your tractor. The dealer can provide skilled personnel, trained by the manufacturer, original service parts and all tools and equipment necessary for your service requirements.

The tractor is designed as a power generator and drive-propulsion unit for use in normal and traditional agricultural conditions.

The tractor is also designed to provide maximum performance, economic running and easy use over a wide range of operations. Prior to delivery, all machines are carefully inspected (by both the Manufacturer and your local authorised dealer), to make sure that they reach the user in perfect condition. To maintain the tractor in this condition and ensure trouble-free operation, the routine maintenance described in Section 3 of this manual must be carried out at the specified intervals.

CLEANING THE TRACTOR

Your tractor is an advanced machine, fitted with an electro-hydraulic control system. Care must be taken when cleaning the tractor, especially if a pressurised water cleaner is used.

- Never stand too close to the tractor or direct the water jet on electrical components, seals or intake openings, etc.
- Never direct jets of cold water at the hot engine or exhaust. See also Section 3 (Recommendations for bodywork maintenance).

SAFETY MEASURES

Safety precautions for the operator and bystanders are shown on page vii to xiii inclusive. Read the safety instructions and follow recommendations and hints **before** starting to use the tractor.

SERVICE AFTER THE FIRST 50 HOURS OF WORK

The operations required for the first service are shown at the end of the Manual, immediately prior to the index.

After the first 50 hours of use, return to the dealer with your tractor and this Manual in order to carry out the Manufacturer's checks and to fill in the certificates included on pages 9-1 and 9-3. The first sheet (page 9-1) must be compiled on completion of the service and held by the dealer. The second sheet (page 9-3) must be kept in the Manual for documentation and reference purposes. **Check that both copies are signed by both yourself and the dealer.**

SPARE PARTS

"Non-original" spare parts have not been tested or authorised by the Manufacturer. Instalment and/or use of such products may adversely affect the tractor's design specifications, thereby compromising operational safety. The manufacturer cannot be held responsible for any damage resulting from the use of "non-original" spare parts.

No modifications may be made to the tractor without written authorisation from the Manufacturer.

WARRANTY

The tractor is guaranteed in accordance with current legislation in your country and in line with contractual agreements reached with the dealer at the time of sale. However, the warranty is no longer valid if the rules and instructions for the use and maintenance of the tractor, described in this Manual, are not observed.

TRACTOR IDENTIFICATION PLATES

Serial numbers identify the tractor and its main components. The identification data must be supplied by the dealer for requests for spare parts or service operations. Identification data is of fundamental importance in the event of theft of the tractor. The location of the various identification data is shown below.

Frame identification data plate.

MDB1964A

Frame and engine type identification plate.

NEW HOLLAND ITALIA S.p.A.	
TIPO	
OMLOGAZIONE	
TELAIO	
MASSA TOTALE AMMISSIBILE (kg)	
CARICO AMMISSIBILE SULL'ASSE ANTERIORE (kg)	DA: A:
CARICO AMMISSIBILE SULL'ASSALE POSTERIORE (kg)	DA: A:
CARICO RIMORCHIABILE AMMISSIBILE	
MASSA RIMORCHIABILE NON FRENATA (kg)	
MASSA RIMORCHIABILE CON FRENATURA INDIPENDENTE (kg)	
MASSA RIMORCHIABILE CON FRENATURA AD INERZIA (kg)	
MASSA RIMORCHIABILE CON FRENATURA ASSISTITA (kg)	
NEW HOLLAND ITALIA S.p.A. MODENA ITALY MADE IN ITALY	COEFFICIENTE ASSORBIMENTO

Tractor frame number identification plate (stamped on the axle support under the bonnet).

★ 0000000000 ★

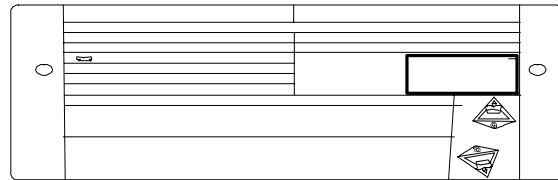

Cab identification data plate (on rear RH side).

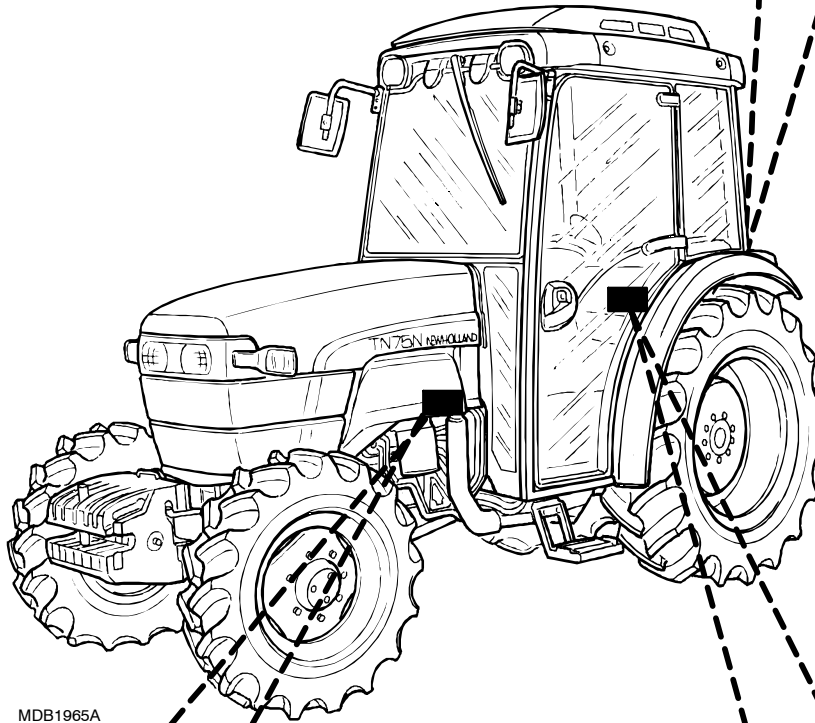

MDB1965A

Frame and engine type identification data plate (inside the cab).

Engine identification plate (on the engine body).

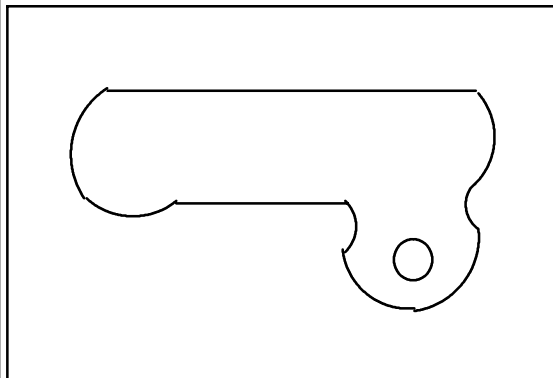

NEW HOLLAND ITALIA S.p.A.	
TIPO	
OMLOGAZIONE	
TELAIO	
MASSA TOTALE AMMISSIBILE (kg)	
CARICO AMMISSIBILE SULL'ASSE ANTERIORE (kg)	DA: A:
CARICO AMMISSIBILE SULL'ASSE POSTERIORE (kg)	DA: A:
CARICO RIMORCHIABILE AMMISSIBILE	
MASSA RIMORCHIABILE NON FRENATA (kg)	
MASSA RIMORCHIABILE CON FRENATURA INDIPENDENTE (kg)	
MASSA RIMORCHIABILE CON FRENATURA AD INERZIA (kg)	
MASSA RIMORCHIABILE CON FRENATURA ASSISTITA (kg)	
NEW HOLLAND ITALIA S.p.A. MODENA ITALY MADE IN ITALY	COEFFICIENTE ASSORBIMENTO <input type="checkbox"/>

INTRODUCTION AND SAFETY MEASURES

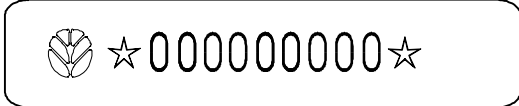
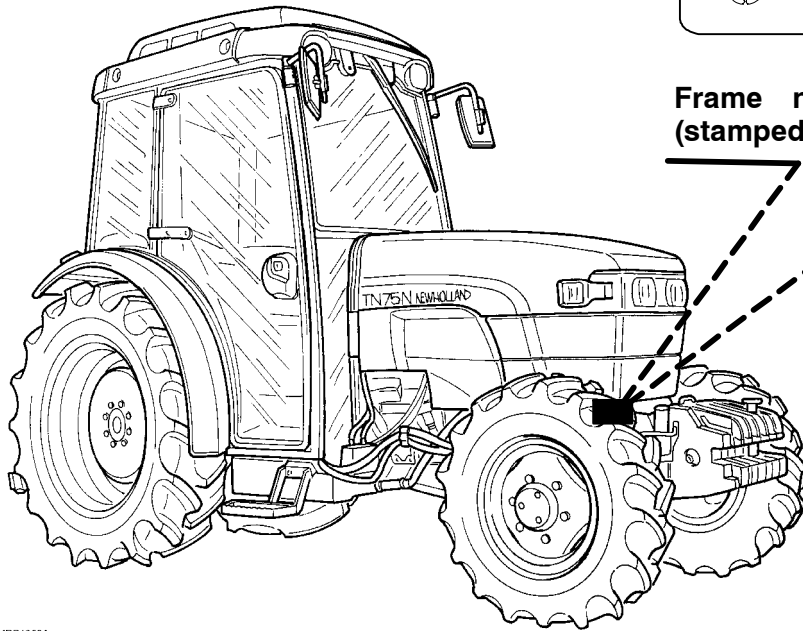

**Frame number identification plate
(stamped on the axle support)**

MDB1969A

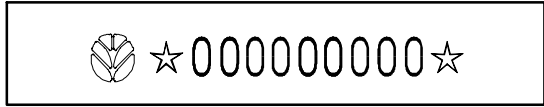
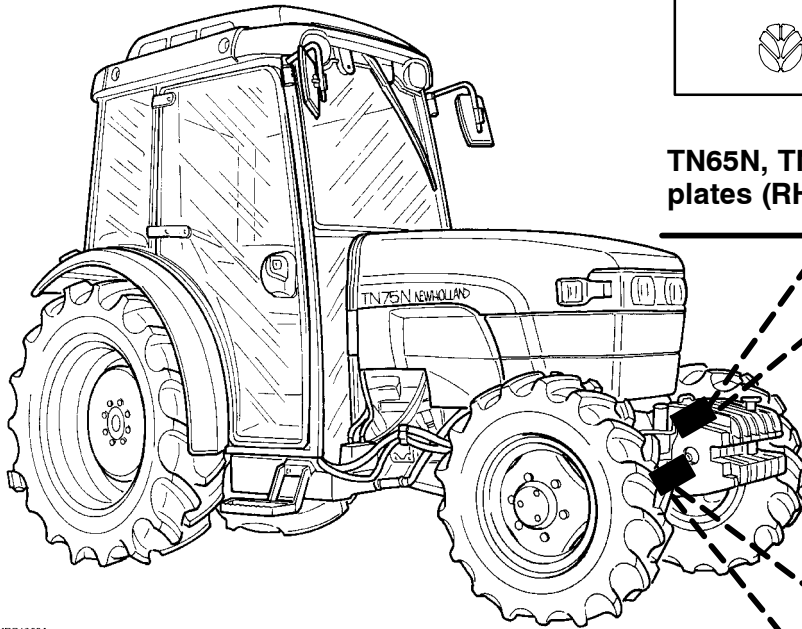

**TN65N, TN75N 4WD axle identification
plates (RH side near stub axles).**

MDB1969A

**TN55V, TN65V and TN75V 4WD axle identification plates
(on front of axle housing).**



IMPORTANT ECOLOGICAL CONSIDERATIONS

Soil, air and water are essential elements for agriculture and for life in general. If local legislation does not control the treatment of certain substances, the production of which is necessitated by advanced technologies, products derived from chemical and petrochemical products must be used and disposed of according to the rules of common sense.

The following recommendations may be of help:

- Find out what the relevant legislation in your country stipulates.
- Ask your suppliers of lubricants, oils, fuels, anti-freeze, detergents, etc., for information on the effects of these products on humans and the environment and for instructions concerning their use, storage and disposal. In many cases, local agricultural consultants will be able to provide assistance.

SUGGESTIONS

1. Avoid using unsuitable, pressurised filling systems or fuel cans when filling tanks, as these may cause considerable spillage and leakage of liquids.
2. As a general rule, do not allow liquid fuels, lubricants, acids, solvents, etc., to come into contact with the skin. The majority of these products contain substances that are potential health hazards.
3. Modern lubricants contain additives. Do not burn contaminated fuel oils and/or oils used in conventional heating systems.
4. Avoid spillage when transferring used engine cooling liquids, engine and transmission lubricants, hydraulic oils, brake fluids, etc.. Never mix used brake oil with fuel oil, or fuel oil with lubricants. Store safely until suitable disposal can be arranged according to national legislation or local regulations.
5. Modern anti-freeze liquids and solutions, e.g.: anti-freeze and other additives, must be replaced every two years. They must not be left to be absorbed into the ground, but must be collected and disposed of in a suitable manner.
6. Do not open the air conditioning systems to carry out work. These systems contain gas which must not be released into the atmosphere. Contact your dealer or specialised personnel, who are equipped with the appropriate equipment and are authorised to re-fill the system.
7. Any leakage or defect in the engine cooling or hydraulic systems must be repaired immediately.
8. Do not increase the pressure in pressurised systems, as this may cause component parts to burst.
9. When welding, make sure that hoses are properly protected as sparks or molten material may puncture or weaken the tubes and sleeves, resulting in leakage of oil, cooling liquid, etc..
10. Do not adjust the setting of the fuel delivery system as this will alter the emission of exhaust fumes.

NOTE: *The engines installed on the tractors comply with anti-pollution legislation.*

ALWAYS WORK SAFELY



This warning symbol points out important messages concerning your safety.

Read the following safety regulations carefully and follow the recommendations in order to avoid potential hazards and safeguard your health and safety

In this manual the symbol is accompanied by the following key-words:



When the warning is to prevent potential damage to the machine, which could also put the operator's safety at risk.



This warning specifically indicates a potential danger to the user or to any other person directly involved.

Failure to observe the instructions preceded by the aforementioned key words (**CAUTION** and **DANGER**) may result in severe or fatal injury to the persons involved.

Furthermore, this manual also contains instructions in italics preceded by the terms **NOTE** and **WARNING**, with the following relevance in relation to machine protection:

NOTE: Underlines the correct procedure or technique to be followed by the operator.



Informs the operator of the danger of damaging the machine if the specified procedure is not followed.

IMPORTANT WARNINGS

The machine is designed and produced exclusively for agricultural use.

All other use will be considered to be contrary to the use specified by NEW HOLLAND, who cannot be held liable for damage to property or the machine, or for personal injuries which may result.

Persons who risk improper use will therefore assume the responsibility for any consequences arising from such use.

Compliance with the instructions for use, maintenance and repairs described in this manual, are the essential preconditions for the use specified by NEW HOLLAND.

The machine must only be used, serviced or repaired by personnel trained in the relevant working methods and safety regulations and who have been authorised to work on the machine.

The user must also observe the rules concerning general safety and accident prevention, including the Highway Code when driving on public highways.

Any arbitrary modifications made to this machine will release NEW HOLLAND from any liability resulting from damage or injury.

NEW HOLLAND and all distribution organisations, inclusive of, but not restricted to, national, regional or local distributors, cannot be held liable for damage resulting from the malfunction of parts and/or components not approved by NEW HOLLAND

Under no circumstances will a guarantee be issued for products made or sold by NEW HOLLAND that are damaged as a result of the malfunction of parts and/or components not approved by NEW HOLLAND.

WORKING SAFELY

1. During the manufacturing of this tractor, every step has been taken to ensure safe operation. However, the best way to avoid accidents is to exercise caution at all times. Once the accident has already happened it is too late to remember what steps should have been taken.
2. Read this manual carefully before starting, using, carrying out maintenance, refuelling or performing any other type of operation on the tractor.
3. The time spent reading this manual will allow you to get to know your tractor, thereby saving time and effort. This will also help prevent accidents from taking place.
4. Read all the safety decals on the machine and follow the instructions thereon before starting, operating, refuelling or carrying out maintenance on the machine. Promptly replace any decals that are damaged, lost or illegible. Clean the decals if they are covered by mud or debris.
5. Remember that the tractor is exclusively designed for agricultural use. Any other use will require prior authorisation from NEW HOLLAND.
6. It is advisable to keep a first aid kit on hand.
7. The tractor must only be used by responsible personnel, trained in tractor use and authorised to operate the machine.
8. Do not alter the injection system calibration in an attempt to increase maximum engine speed.
9. Do not wear loose clothing that may be trapped in moving parts.
Check that all rotating parts connected to the power take-off are correctly protected.
10. Do not alter the calibration of the pressure relief valves in the various hydraulic circuits (hydrostatic steering, hydraulic lift, auxiliary distributors, etc.).
11. Avoid using the tractor in unsuitable physical conditions, stop work instead.
12. Enter and leave the tractor using the steps and handles provided. Keep these fittings free of mud and debris.
13. Always operate with the cab or roll bar correctly and securely fitted on the tractor: periodically check that the fittings are not loose and that all parts of the structure are free from any damage and deformation. Do not modify the roll bar by welding parts, drilling holes, etc., as this could adversely affect the rigidity of the structure.

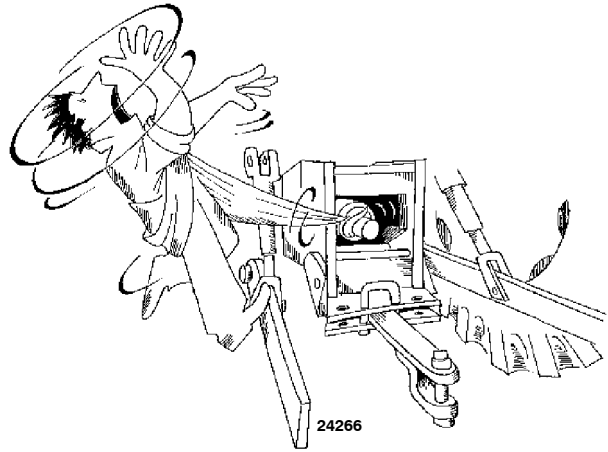

INTRODUCTION AND SAFETY MEASURES

STARTING THE TRACTOR

Before starting the engine, check that the handbrake is on and that the gears and power take-off are disengaged, even if the tractor is fitted with a start-up safety device. Never disconnect the start-up safety switch. If the switch does not work correctly, contact your local dealer for eventual repair operations.

14. Before starting the engine, make sure that all attached implements are lowered to the ground.

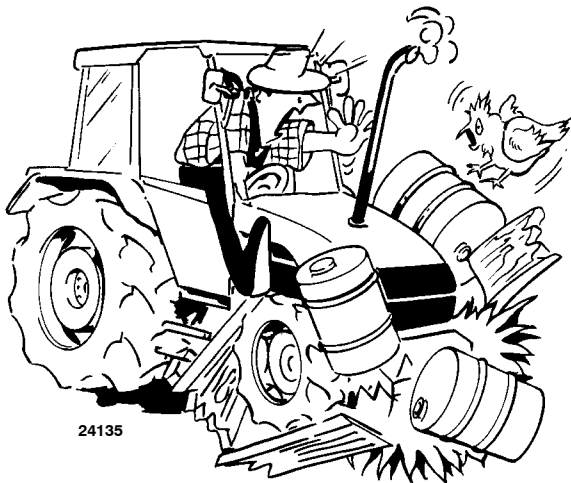

15. Before starting the engine, check that all covers and guards are correctly in position (roll bar, bonnet side panels, power take-off guard, front axle transmission shaft cover, etc.).

16. **Never start or manoeuvre the tractor unless seated in the driving position.**

17. Before moving the tractor, always check that the area is free of persons or obstacles.

18. Never run the engine in a closed space without ensuring adequate ventilation. Exhaust fumes are damaging to the health and can be lethal.

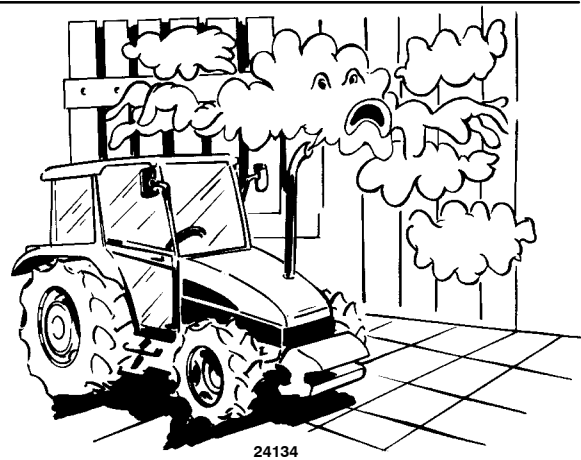

USING THE TRACTOR

19. Select the most suitable wheel setting for the work in hand, i.e.: the setting that provides the best stability.

20. Engage the clutch slowly: if engaged too quickly, especially when the tractor is getting out of a hole, ditch or operating on muddy ground or steep slopes, the tractor may overturn. Release the clutch immediately if the front wheels start to lift.

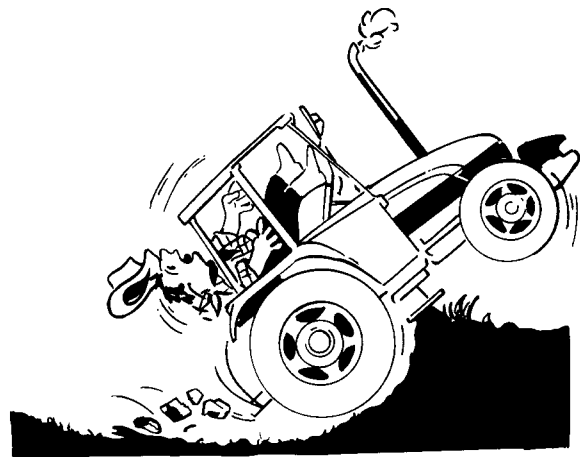

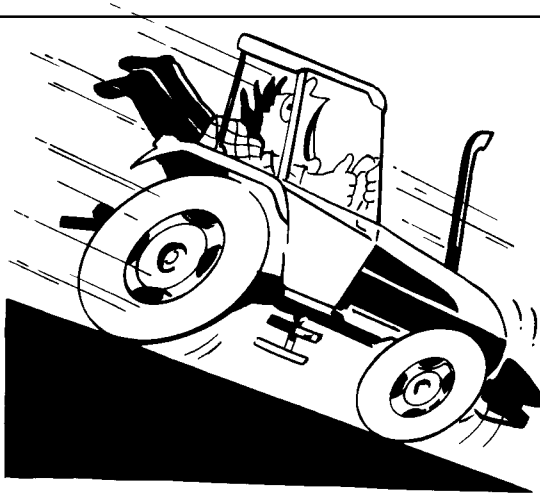

24223

21. When travelling downhill, keep the tractor in gear. Never release the clutch and never leave the gears in neutral.

22. When the tractor is moving, the operator must remain correctly seated in the driving position.

23. Never get on or off the tractor while in movement.

24. When using the brakes, press the pedal down slowly.

25. Avoid curving at high speeds.

26. Always use the tractor at a speed that will guarantee safe operation on the type of land being worked. When working on uneven ground, use maximum care to ensure proper stability.

27. If you have to work with the tractor on a gradient, for example on hillsides, drive at moderate speed especially when taking curves.



24137

28. Proceed with maximum caution when working with the wheels near the edge of ditches or slopes.

29. When driving on public highways, observe the Highway Code.

30. When driving, do not rest your feet on the brake or clutch pedals.

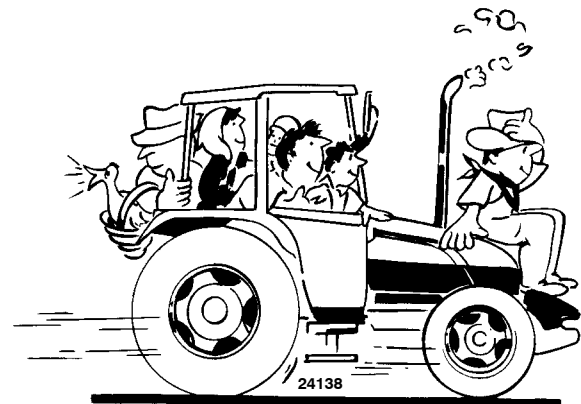

24138

31. Never carry passengers, not even inside the cab, unless the machine is fitted with an approved extra seat.

32. When driving on roads, connect the brake pedals using the plate provided. Braking with single pedals can cause the tractor to skid. Avoid excessive wear on the brakes by using engine braking.

INTRODUCTION AND SAFETY MEASURES

TOWING AND TRANSPORT

33. To guarantee tractor stability when moving, adjust the hitching device according to the trailer or implement to be used (see Caution on page 7-4).
34. Drive slowly when towing extremely heavy loads.
35. For your own safety, do not tow trailers that are not fitted with an independent braking system.
36. If the tractor is used to tow heavy loads, always use the hitching device and never hitch loads onto the lower arms or the top link of the three-point linkage. This may result in tipping or overturning.



37. When towing, do not negotiate curves with the differential lock engaged as this may prevent you from steering the tractor.

USING IMPLEMENTS AND AGRICULTURAL MACHINERY

38. Do not connect implements or machinery that require more power than can be generated by your tractor model.

39. Never negotiate sharp curves with the power take-off under a heavy load; this may damage the universal joints on the transmission shaft connected to the power take-off.
40. Never stand between the reversing tractor and the implement when hitching.
41. When using implements that require the tractor to be stationary with the engine running, keep the gear and range levers in the neutral position, apply the handbrake and use suitable wheel chocks.

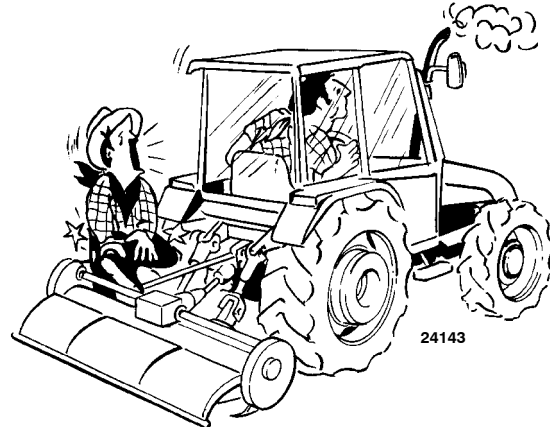

42. Do not operate machines connected to the power take-off without first ensuring that the operating range of the machine is free of bystanders. Also check that all rotating parts connected to the power take-off shaft are correctly protected.
43. Add rear ballast when using lifting equipment fitted to the front of the tractor.

Thank you so much for reading.
Please click the “Buy Now!”
button below to download the
complete manual.



After you pay.

You can download the most
perfect and complete manual in
the world immediately.

Our support email:

ebooklibonline@outlook.com