

970 Tractors

Operators Manual

9-4682

Reprinted

CASE III



*This symbol means **ATTENTION! BECOME ALERT! YOUR SAFETY IS INVOLVED.** The message that follows the symbol contains important information about your safety. Carefully read the message. Make sure you fully understand the causes of possible injury or death.*

SB001

IF THIS MACHINE IS USED BY AN EMPLOYEE, IS LOANED, OR IS RENTED, MAKE SURE THAT THE OPERATOR UNDERSTANDS THE TWO INSTRUCTIONS BELOW.

BEFORE THE OPERATOR STARTS THE ENGINE:

1. GIVE INSTRUCTIONS TO THE OPERATOR ON SAFE AND CORRECT USE OF THE MACHINE.
2. MAKE SURE THE OPERATOR READS AND UNDERSTANDS THE OPERATOR'S MANUAL FOR THIS MACHINE.



IMPROPER OPERATION OF THIS MACHINE CAN CAUSE INJURY OR DEATH.

BEFORE STARTING THE ENGINE, DO THE FOLLOWING:

1. READ THE OPERATOR'S MANUAL.
2. READ ALL SAFETY DECALS ON THE MACHINE.
3. CLEAR THE AREA OF OTHER PERSONS.

LEARN AND PRACTICE SAFE USE OF MACHINE CONTROLS IN A SAFE, CLEAR AREA BEFORE YOU OPERATE THIS MACHINE ON A JOB SITE.

It is your responsibility to observe pertinent laws and regulations and to follow manufacturer's instructions on machine operation and maintenance.

See your Authorized Case dealer for additional operator's manuals, parts catalogs, and service manuals.



THIS SAFETY ALERT SYMBOL INDICATES IMPORTANT SAFETY MESSAGES IN THIS MANUAL. WHEN YOU SEE THIS SYMBOL, CAREFULLY READ THE MESSAGE THAT FOLLOWS AND BE ALERT TO THE POSSIBILITY OF PERSONAL INJURY.

Tractor accidents kill a number of people in the United States every year. Studies show that 6 in 10 tractor fatalities result from upsets.

Stability is still a very important factor in safety. Let's face it - tractors must be built higher than automobiles to provide the ground clearance necessary in performing their intended function. The use of a tractor over irregularities in the fields calls for careful handling and using good common sense.

Speed is an important element in tractor stability. Speed brings us back to you, the operator. Only you can hold down your speed to match conditions. Think ahead - drive defensively. Equip your tractor with a Case ROPS system available as a factory or field installed option from your Case dealer.

We at Case are continuing to contribute to your safety in two ways: by building tractors with an extra measure of protection and comfort . . . and by passing on these suggestions for safer operation.



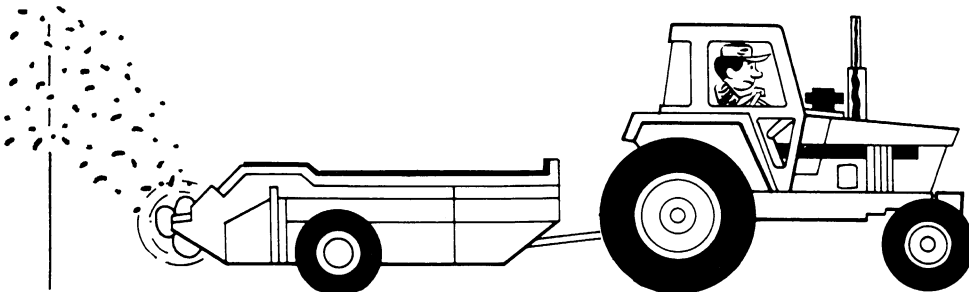

Before starting the engine, place all controls in neutral. This will ease starting loads on the starter and batteries and will eliminate the accidental start up of PTO driven equipment.





Before leaving the tractor, stop the engine, place all controls in neutral and set the parking brake.

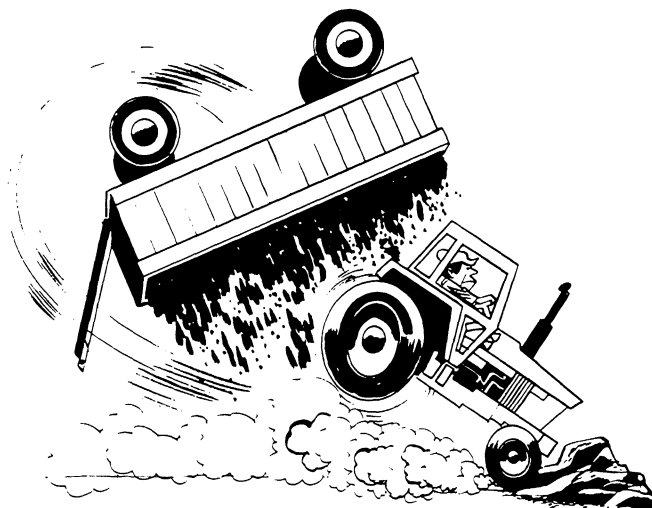

 Engine starting and control operation must be performed from the operators seat only.

 Tractor travel speed should be such that complete control and tractor stability is maintained at all times. There is potential danger in maneuvering around ditches, gullies, slopes, uneven ground, holes and rocks.



 Brake pedals must be locked together for road travel. This will insure uniform brake application and maximum stopping ability.

 Excess tractor speed is the big killer. Only experienced drivers should be permitted on highways. Use SMV safety emblem and lights for adequate warning to the operators of other vehicles. In this regard, check local government regulations.

Stop, look and listen before entering a highway, stay on your side of the road and pull over to let faster traffic pass. Slow down and signal as you turn off. Shift down before you start up or down a hill with a heavy load. Avoid “free-wheeling”.

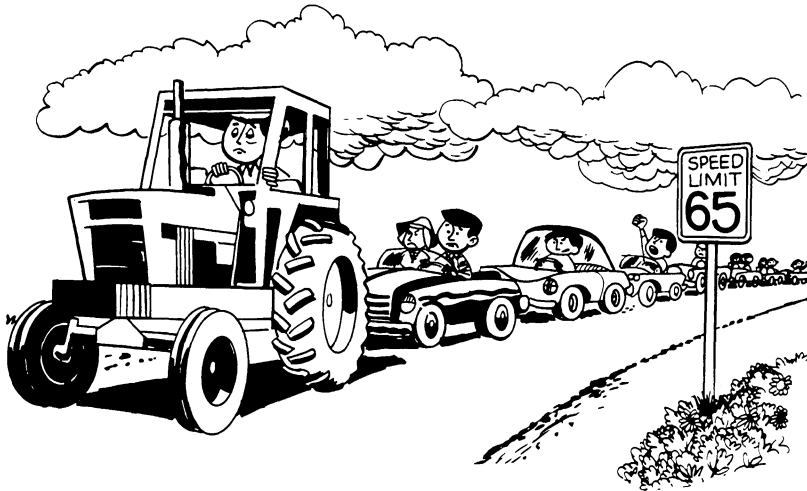

Extra weight increases your braking distance. Remember that liquid in the tires, weights on the tractor or wheels, tanks filled with fertilizer, herbicides or insecticides - all these add weight and increase the distance you need in which to stop.

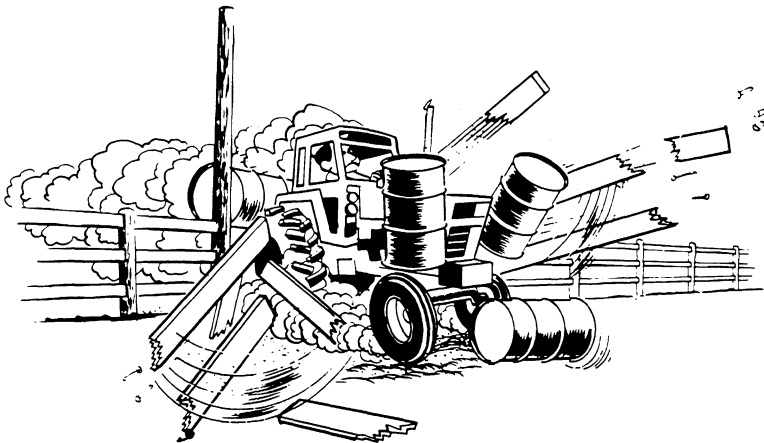

 Keep shields over moving parts. Any unguarded shaft, pulley, sprocket or moving part is a potential safety hazard. Wear close fitted clothing.

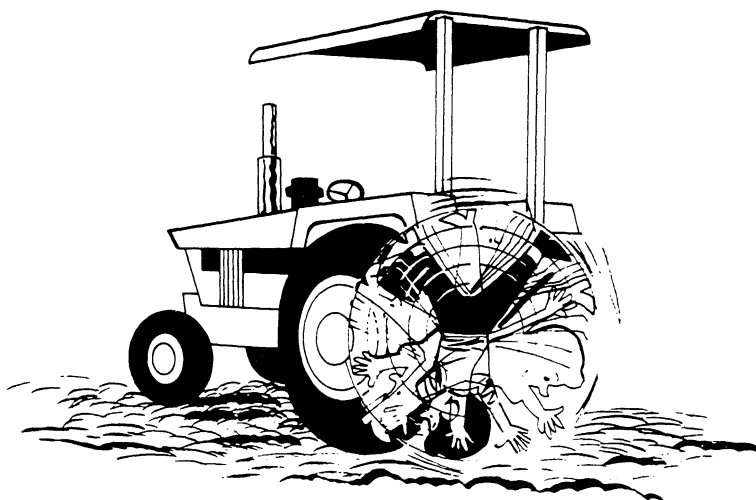

 Hitch to the drawbar, or to other specified hitch points. If you hitch to the axle - or anywhere that's too high - the front end will come up FAST and you have only 7/10 of a second to de-clutch!, or prevent an upset.

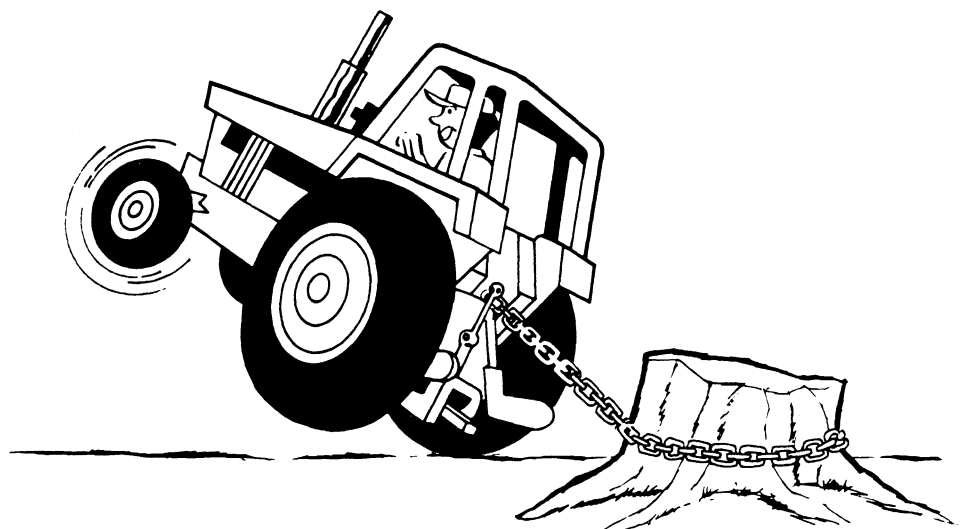

Try to balance the load primarily on the implement wheels - as in loading a trailer or spreader. Avoid overloading the drawbar. Add front end weights for improved stability. Engage the clutch smoothly, avoid jerking and use the brakes cautiously to avoid jack-knifing.

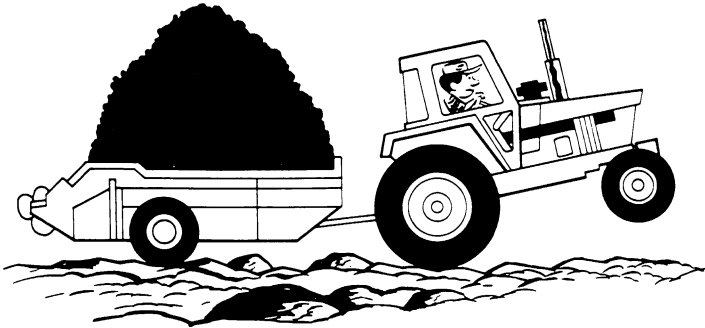

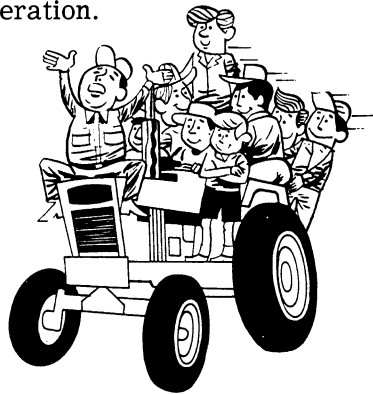

Only one person - the operator - should be permitted on a tractor when it is in operation.





Never operate the engine in a closed building. Proper ventilation is required under any circumstances.





 Never service or make adjustments to the tractor with the engine running or with the tractor in motion.

 Never refuel the tractor when the engine is hot or running.

 Never smoke while refueling the tractor, servicing the fuel system, checking the batteries or using cold weather starting aids.

 Add coolant to the radiator only when the engine is stopped or slowly idling. To avoid being scalded when the pressure - type filler cap is being removed, turn the cap slowly to the first stop position to relieve pressure before removing the cap.

 When using jumper cables always connect positive jumper cable to battery terminal on starter solenoid. Then use normal starting procedure from operator's seat. Any other method could result in tractor runaway.

 If the tractor is equipped with a 4 post ROPS structure or a ROPS protected cab, use the seat belts. The seat belts can help insure your safety if they are used and maintained.

 On a mobile power take-off application, always disengage the PTO before dismounting from the tractor.

 When doing stationary PTO work and dismounting from the tractor with the PTO running, keep clear of all moving parts as they are a potential safety hazard.

 Always stop the tractor engine before working on a PTO driven machine.

 It is good practice to carry a fire extinguisher on the tractor. Be sure that the extinguisher is properly maintained and be familiar with its proper use.

 Provide a first-aid kit for use in case of accident.

TO THE PURCHASER OF A CASE TRACTOR

The care you give your Case Tractor will greatly determine the satisfaction and service life you will obtain from it. Use this manual as your guide. By observing the instructions and suggestions in this manual, your Case Tractor will serve you well for many years.

As an Authorized Case Dealer, we stock Genuine Case Parts, which are manufactured with the same precision and skill as the original equipment. Our factory trained staff is kept well informed on the best methods of servicing Case equipment and is ready and able to help you.

Should you require additional aid or information, contact us.

YOUR AUTHORIZED CASE DEALER

TO INSURE EFFICIENT AND PROMPT SERVICE, PLEASE FURNISH US WITH THE MODEL, SERIAL, ENGINE, TRANSMISSION AND CAB SERIAL NUMBERS OF YOUR TRACTOR IN ALL CORRESPONDENCE OR CONTACTS.



SERIAL NUMBERS

When ordering parts from your Authorized Case Dealer and in all contacts or correspondence with your dealer, relative to your Case Tractor, always specify the Model, Tractor Serial Number, Engine, Transmission and Cab Serial Numbers.

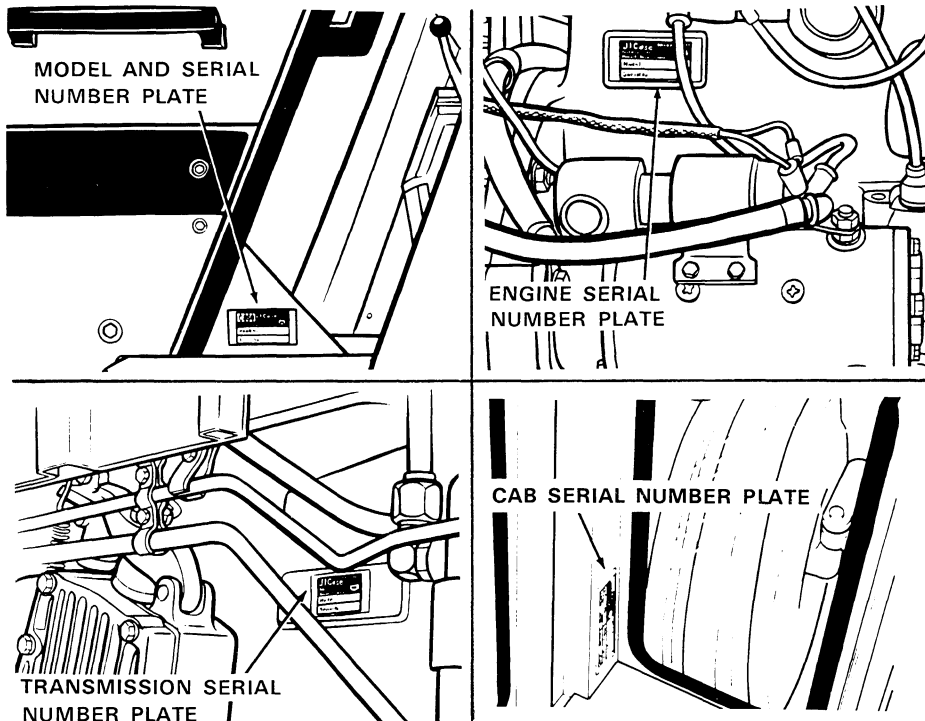

For convenient reference, fill in the Serial Numbers of your tractor in the spaces provided below.

MODEL DESIGNATION _____
TRACTOR SERIAL NUMBER _____
ENGINE SERIAL NUMBER _____
TRANSMISSION SERIAL NUMBER _____
CAB SERIAL NUMBER _____

NOTE: The terms "Right Hand" and "Left Hand" whenever used in this manual, apply to the tractor as viewed when seated in the operator's seat facing the forward direction of travel.

Diesel Engine

SPECIFICATIONS

General

Type	6 Cylinder, 4 Stroke Cycle, Valve-in-Head.
Firing Order	1-5-3-6-2-4
Bore	4-1/8 Inches (104.7mm)
Stroke	5 Inches (127mm)
Piston Displacement	401 Cubic Inches (6 571.2cm ³)
Compression Ratio	16.5 to 1
Cylinder Sleeve	Removable Wet Type
No Load Governed Speed	2140 to 2180 RPM
Rated Engine Speed	2000 RPM
Engine Idling Speed	700 to 750 RPM
*Valve Tappet Clearance (Exhaust)	(Hot) .020 Inch (0.508mm) (Cold) .025 Inch (0.635mm)
(Intake) - (Hot and Cold)	.015 Inch (0.381mm)

*Hot Settings Are Made After The Engine Has Operated At Thermostat Controlled Temperature For At Least Fifteen Minutes.

Piston and Connecting Rods

Rings per piston	3
Number of Compression Rings	2
Number of Oil Rings	1
Type Pins	Full Floating Type
Type Bearing	Replaceable Precision, Steel Back, Copper-Lead or Aluminum Alloy Liners

Main Bearings

Number of Bearings	7
Type Bearings	Replaceable Precision Steel Back, Copper-Lead or Aluminum Alloy Liners.

Engine Lubricating System

Oil Pressure ----- 45 to 60 PSI (310 to 414 kPa)
and Operating at Rated Engine Speed

Type System ----- Pressure and Spray Circulation

Oil Pump ----- Gear Type

Oil Filter ----- Full Flow Spin on Type

Fuel System

Fuel Injection Pump ----- Robert Bosch, Type PES
(Multiple Plunger).

Pump Timing ----- 30 Degrees Before Top Dead
Center (Port Closing).

Fuel Injectors ----- Pencil Type
Opening Pressure 3200 PSI (22 063 kPa)

Fuel Transfer Pump ----- Plunger Type, Integral Part of
Injection Pump.

Governor ----- Variable Speed, Fly-Weight Centri-
fugal Type; Integral Parts of
Injection Pump.

1st Stage fuel filter ----- Full Flow Spin on Type

2nd Stage fuel filter ----- Full Flow Spin on Type

Fuel Tank Water Trap and Drain ----- Located in Base of Fuel Tank

Fuel Tank Capacity ----- 50 U.S. Gallons (189.3 Litres)

Fuel Level Gauge ----- Electric, Located on Instrument Panel.

Hand Primer Pump ----- Located on Top of the Fuel
Transfer Pump.

Preliminary Fuel Filter Located at the Bottom of the
Fuel Transfer Pump.

Fuel Tank Filter ----- Located in Fuel Shut-Off Valve
in Base of Fuel Tank.

spark ignition engines

SPECIFICATIONS

General

Type	6 Cylinder, 4 Stroke Cycle, Valve-in-Head.
Firing Order	1-5-3-6-2-4
Bore	4 Inches (101.6mm)
Stroke	5 Inches (127mm)
Compression Ratio	7.5 to 1
Piston Displacement	377 Cubic Inches (6178cm ³)
Governed Speed	
No Load Governed Speed	2160 to 2200 RPM
Rated Engine Speed	2000 RPM
Engine Idling Speed	600 to 650 RPM
*Valve Tappet Clearance (Intake) (Hot and Cold) .015 Inches (0.381mm)	
(Exhaust)	(Hot) .020 Inches (0.508mm)
	(Cold) .025 Inches (0.635mm)
Exhaust Valve Rotators	Positive Type

*Hot Settings Are Made After The Engine Has Operated At Thermostat Controlled Temperature For At Least Fifteen Minutes.

Piston and Connecting Rods

Rings per Piston	4
Number of Compression Rings	3
Number of Oil Rings	1
Type Pin	Full Floating Type
Type Bearings	Replaceable, Precision Steel Back, Copper-Lead or Aluminum Alloy Liners.

Main Bearings

Number of Bearings	7
Type Bearings	Replaceable, Precision Steel Back, Copper-Lead or Aluminum Alloy Liners.

Buy Now



Our support email:

ebooklibonline@outlook.com