



Service Repair Manual

Models

336D2 L Excavator

Product: EXCAVATOR

Model: 336D2 L EXCAVATOR HBH

Configuration: 336D2 L Excavators HBH00001-UP (MACHINE) POWERED BY C9 Engine

Disassembly and Assembly 336D 2L and 340D 2L Excavators Machine Systems

Media Number -M0065626-02

Publication Date -01/09/2015

Date Updated -14/12/2017

i06605028

Travel Motor - Disassemble

SMCS - 4351-015

Disassembly Procedure

Table 1

| Required Tools | | | |
|----------------|-------------|--|-----|
| Tool | Part Number | Part Description | Qty |
| A | 1U-7506 | Adapter | 1 |
| | 8T-4244 | Nut | 6 |
| | 8T-4223 | Hard Washer | 6 |
| | - | M12 x 1.75 x 250 mm (10 inch) Threaded Rod | 1 |
| B | 8T-0651 | Bolt | 1 |
| | 8T-4167 | Hard Washer | 1 |
| C | 3E-3882 | Eyebolt | 1 |
| D | 1P-1859 | Retaining Ring Pliers | 1 |
| E | 1P-0510 | Driver Gp | 1 |
| | 9S-9152 | Bearing Puller Gp | 1 |
| F | 1P-1861 | Retaining Ring Pliers | 1 |

Start By:

- a. Remove the travel motor.
 1. Fasten the travel motor in Tooling (A) in a vertical position. The weight of the travel motor is approximately 88 kg (195 lb).

- Put an alignment mark across the head and the body of the travel motor for assembly purposes. The head must be reinstalled in the head's original position on the body of the travel motor.



Illustration 1

g00887295

 **WARNING**

Personal injury can result from being struck by parts propelled by a released spring force.

Make sure to wear all necessary protective equipment.

Follow the recommended procedure and use all recommended tooling to release the spring force.

Note: During the removal of head (2) from the travel motor, be careful not to damage the mating surfaces of the components.

- Remove bolts (1).
- Remove head (2) from the body of the travel motor.

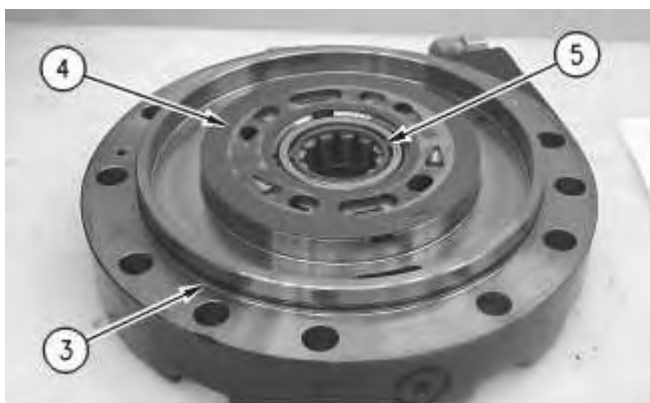

5. Remove O-ring seal (3), port plate (4), and bearing (5).

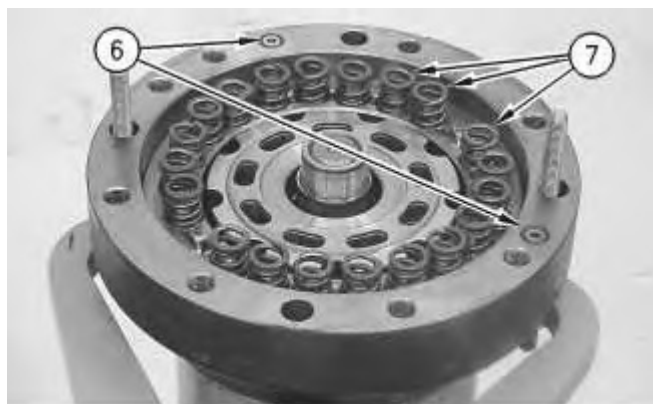

Illustration 3

6. Remove O-ring seals (6). Remove springs (7).

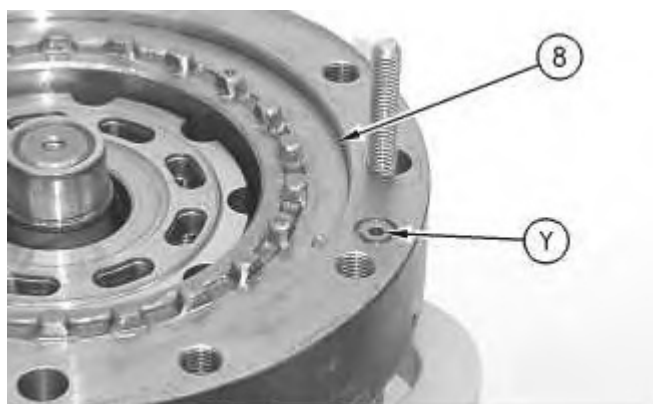

Illustration 4

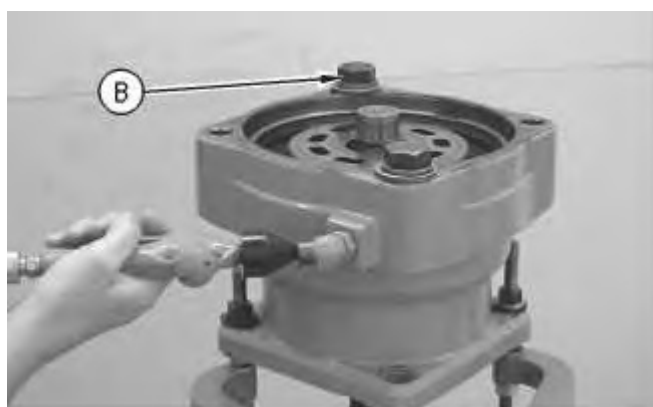

Illustration 5

Example of the use of Tooling (B).

7. Place a shop towel over brake piston (8). Retain brake piston (8) with Tooling (B). Apply approximately 525 kPa (75 psi) of shop air pressure to brake release Port (Y). Make sure that the shop air pressure is free of water. Brake piston (8) will move up the piston guide, and out of the piston guide. Remove brake piston (8) from the body of the travel motor.



Illustration 6

g00887336

8. Remove seal (9) and backup ring (10) from the brake piston.
9. Remove seal (11) and backup ring (12) from the brake piston.



Illustration 7

g00887355

10. Remove plates (13) and friction discs (14).

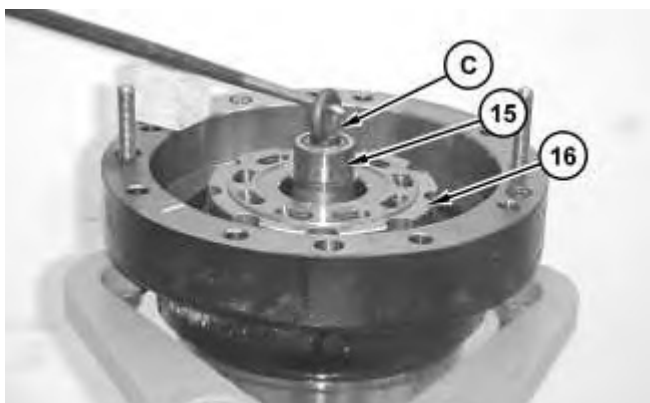

Illustration 8

g02107957

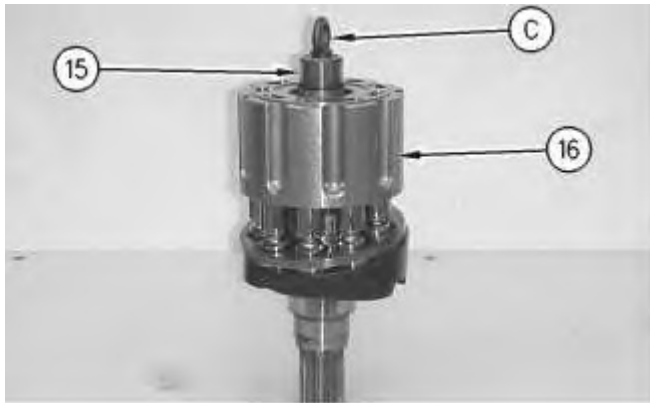

Illustration 9

g00887405

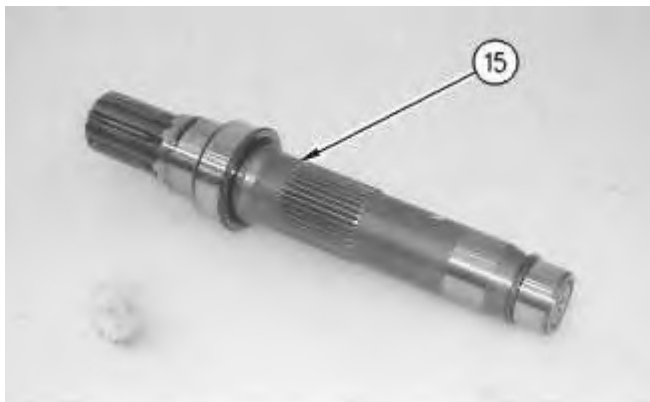

Illustration 10

g00887424

11. Install Tooling (C) into shaft (15). Use a prybar to remove the rotating assembly (16) from the housing.
12. Remove Tooling (C) from shaft (15).
13. Remove shaft (15) from rotating assembly (16).

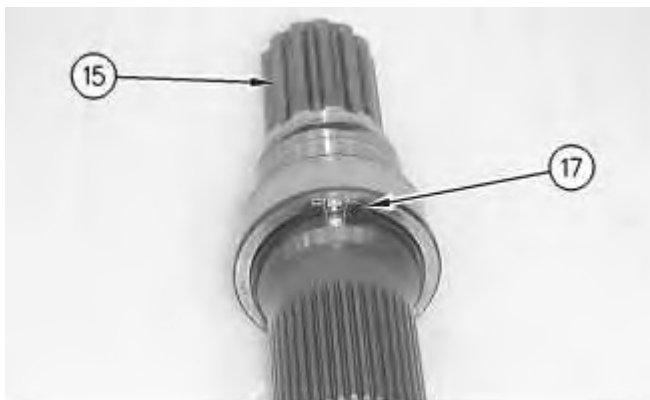

Illustration 11

g00887426

14. Use Tooling (D) to remove retaining ring (17) from shaft (15).

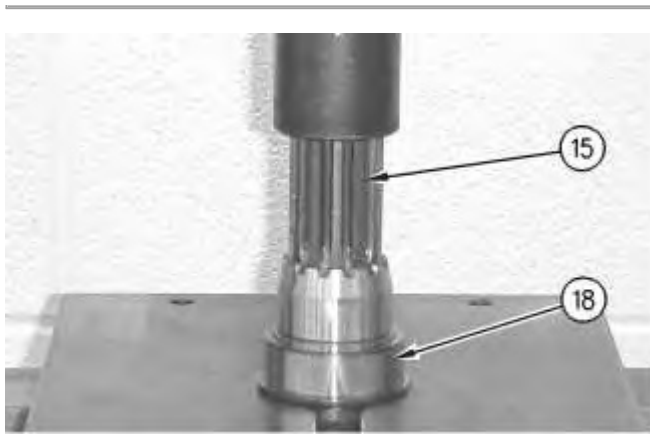

Illustration 12

g00887445

15. Use a suitable press to remove bearing race (18) from shaft (15).

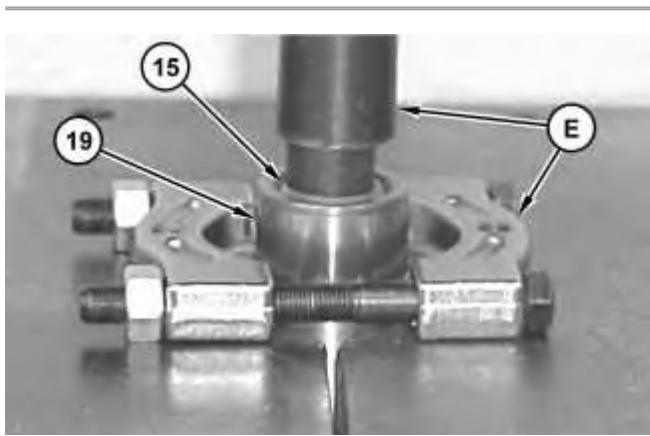

Illustration 13

g03870797

16. Rotate shaft (15). Use a suitable press and Tooling (E) to remove bearing race (19) from shaft (15).



Illustration 14

g03870686

17. Remove cam plate (20) from barrel assembly (16).

Thank you so much for reading.
Please click the “Buy Now!”
button below to download the
complete manual.



After you pay.

You can download the most
perfect and complete manual in
the world immediately.

Our support email:

ebooklibonline@outlook.com