



Service Repair Manual

Models

D6T XL TRACK-TYPE TRACTOR

Product: TRACK-TYPE TRACTOR

Model: D6T XL TRACK-TYPE TRACTOR DTD

Configuration: D6T TRACK-TYPE TRACTOR XL VPAT, XW VPAT, LGP VPAT, Differential Steering DTD00001-UP (MACHINE) POWERED BY C9.3 Engine

Disassembly and Assembly D6T Track-Type Tractor Power Train

Media Number -KENR8911-03

Publication Date -01/03/2016

Date Updated -07/03/2016

i05236971

Final Drive - Disassemble

SMCS - 4050-015

Disassembly Procedure

Table 1

Required Tools			
Tool	Part Number	Part Description	Qty
A	138-7573	Link Bracket	3
	1A-2029	Bolt	1
B	1P-510	Driver Group	1
C	FT-1934	Beam	1
	6V-3160	Double Acting Cylinder	1
	6V-9061	Pump Group	1
	1D-4621	Bolt	4
D	138-7574	Link Bracket	2
	2A-1538	Bolt	2

Start By:

- A. Remove the final drives.

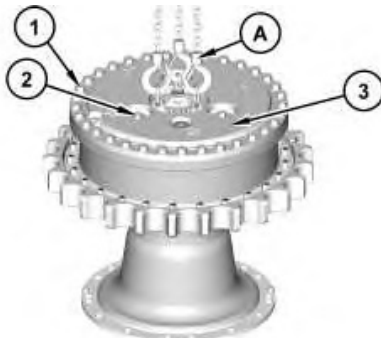

1. Install Tooling (A) and a suitable lifting device to planetary carrier (3) .
2. Remove bolts (1). Remove planetary carrier (3) and the two O-ring seals from the hub. The weight of planetary carrier (3) is approximately 137 kg (302 lb).
3. Remove retainers (2) .

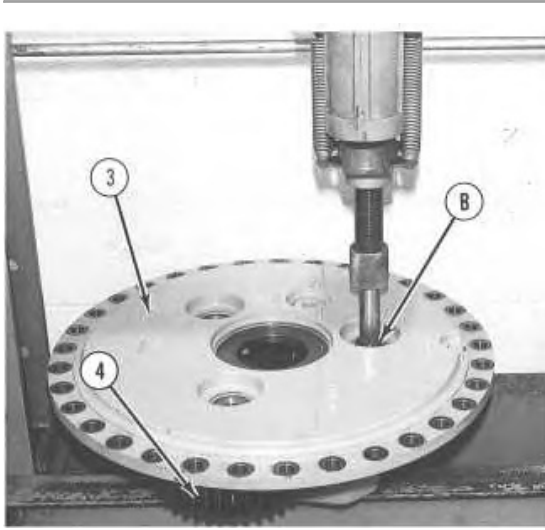

Illustration 2

g00841089

4. Place support under planetary carrier (3) in order to prevent damage. Use Tooling (B) and a suitable press to remove the planetary gear shafts.
5. Remove planetary gears (4) from planetary carrier (3) .

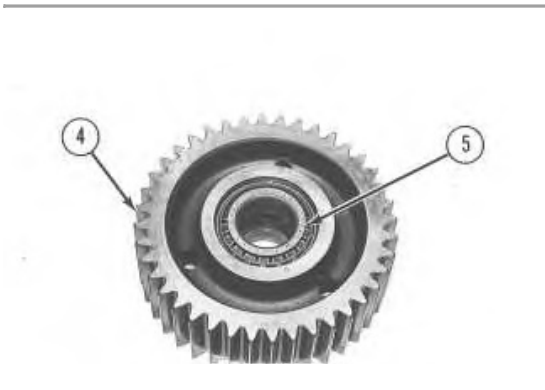

Illustration 3

g00841091

6. Remove bearing cones (5) from gears (4) .
 7. Remove the bearing cups from each side of the gears.
-

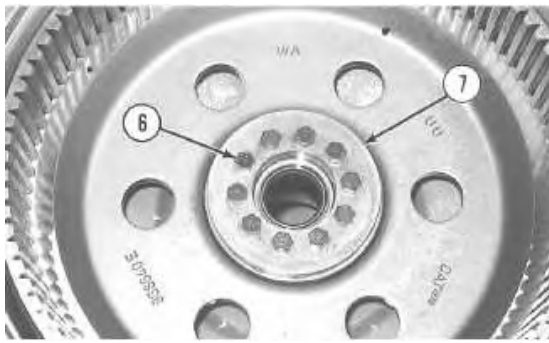

Illustration 4

g00841092

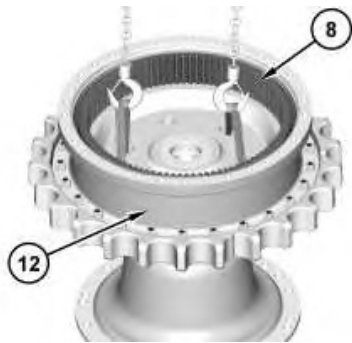

Illustration 5

g01195913

8. Remove bolts (6) and retainer (7) .
9. Attach a suitable lifting device to hub (12) and ring gear (8). The weight of hub (12) and ring gear (8) is approximately 68 kg (150 lb). Remove hub (12) and ring gear (8) .



Illustration 6

g01195915

10. Turn over hub (9) and ring gear (8). Remove retaining ring (10). Attach a suitable lifting device to hub (9). The weight of hub (9) is approximately 37 kg (82 lb). The weight of ring gear (8) is approximately 32 kg (71 lb). Remove hub (9) .

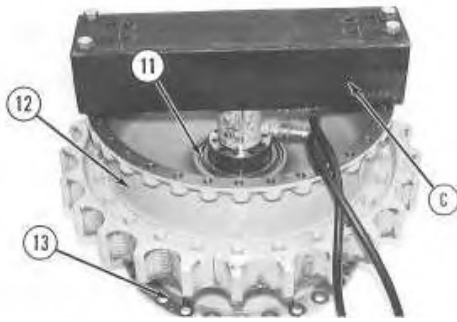

Illustration 7

g00841095

11. Install Tooling (C) on hub (12).

Note: Do not lift hub (12) too high. Do not allow hub (12) to contact the fitting on the hydraulic cylinder.

12. Use Tooling (C) to loosen hub (12) from spindle (13). Remove Tooling (C) .
13. Remove bearing cone (11) .



Illustration 8

g01195917

14. Install Tooling (D) and a suitable lifting device to hub (12). Remove hub (12) from spindle (13). The weight of hub (12) is approximately 180 kg (397 lb).

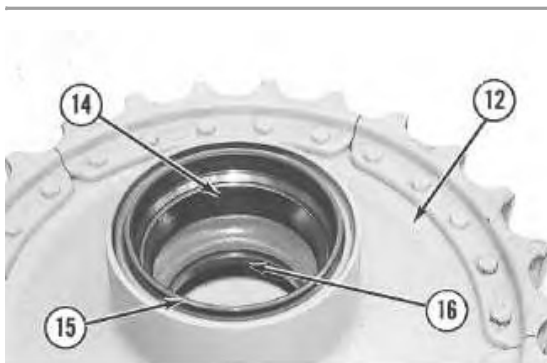

Illustration 9

g00841099

15. Turn over hub (12). Remove Duo-Cone seal kit (15). Use a hammer and a punch to remove bearing cup (16) .
16. Turn over the hub. Remove bearing cup (14) from the hub.

Thank you so much for reading.
Please click the “Buy Now!”
button below to download the
complete manual.



After you pay.

You can download the most
perfect and complete manual in
the world immediately.

Our support email:

ebooklibonline@outlook.com