



Service Repair Manual

Models

M315D WHEELED Excavator

Product: WHEELED EXCAVATOR

Model: M315D WHEELED EXCAVATOR W5M

Configuration: M315D Excavator W5M00001-UP (MACHINE) POWERED BY C4.4 Engine

Disassembly and Assembly

M315D, M315D Series 2, M315D2, M317D Series 2 and M317D2 Wheeled Excavators Machine Systems

Media Number -KENR6028-05

Publication Date -01/07/2015

Date Updated -08/07/2015

i02817263

Main Hydraulic Pump - Disassemble

SMCS - 5070-015

Disassembly Procedure

Table 1

Required Tools			
Tool	Part Number	Part Description	Qty
A	1P-1861	Retaining Ring Pliers	1
B	1U-7600	Slide Hammer Puller Gp	1

Start By:

- Remove the main hydraulic pump. Refer to Disassembly and Assembly, "Main Hydraulic Pump and Pump Drive Coupling - Remove".

NOTICE

Keep all parts clean from contaminants.

Contaminants may cause rapid wear and shortened component life.

NOTICE

Care must be taken to ensure that fluids are contained during performance of inspection, maintenance, testing, adjusting, and repair

of the product. Be prepared to collect the fluid with suitable containers before opening any compartment or disassembling any component containing fluids.

Refer to Special Publication, NENG2500, "Dealer Service Tool Catalog" for tools and supplies suitable to collect and contain fluids on Cat products.

Dispose of all fluids according to local regulations and mandates.

Note: Note the location and orientation of the components for assembly purposes.

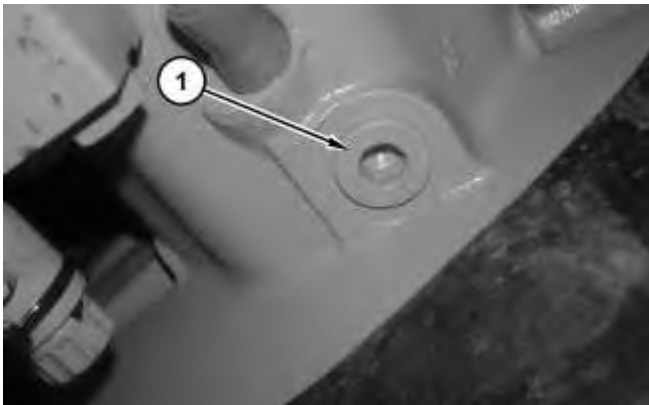

Illustration 1

g01247191

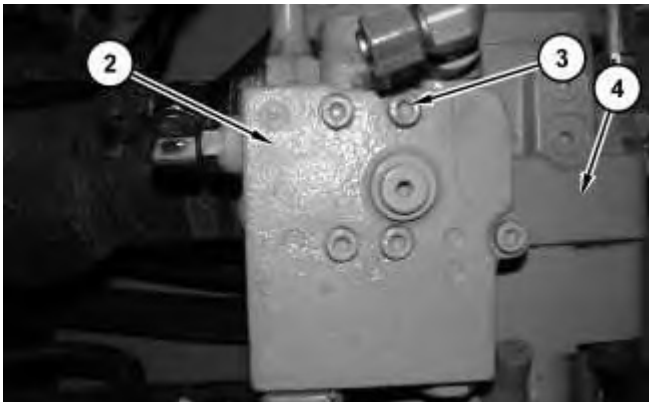

Illustration 2

g01247153

 **WARNING**

Personal injury can result from being struck by parts propelled by a released spring force.

Make sure to wear all necessary protective equipment.

Follow the recommended procedure and use all recommended tooling to release the spring force.

1. Remove bolts (3) and valve assembly (2).
2. Remove plug (1) and the O-ring seal from piston pump (4).

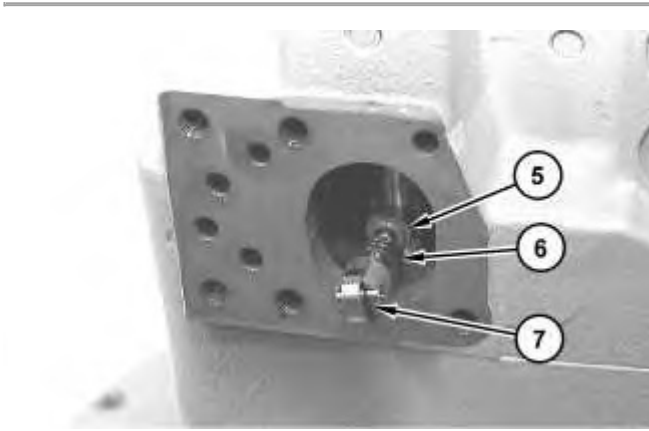

Illustration 3

g01173466

3. Remove roller (7), spring (6), and piston (5).

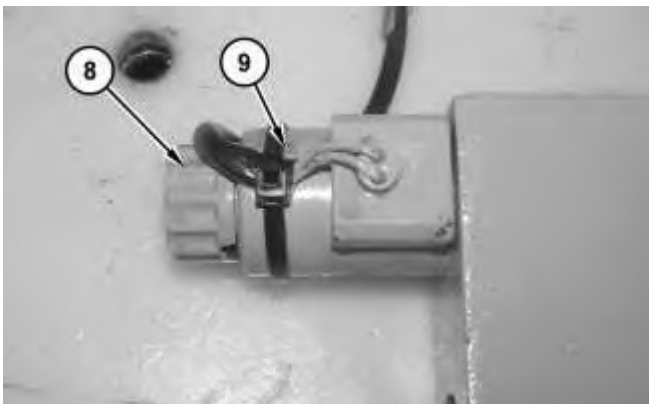

Illustration 4

g01247146

4. Remove nut (8) and coil (9).
-

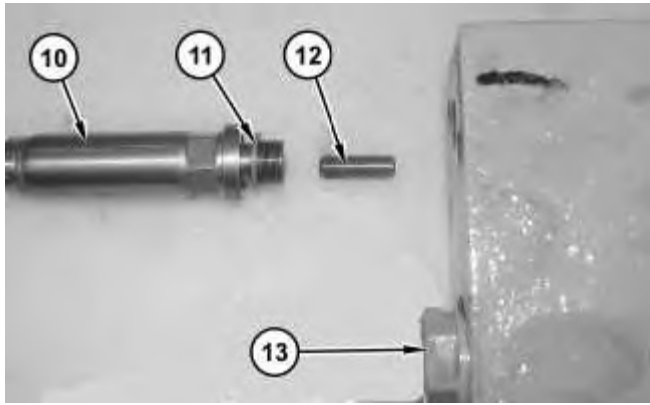

Illustration 5

g01247149

5. Remove cartridge (10), O-ring seal (11), pin (12), plug (13), and the O-ring seal.

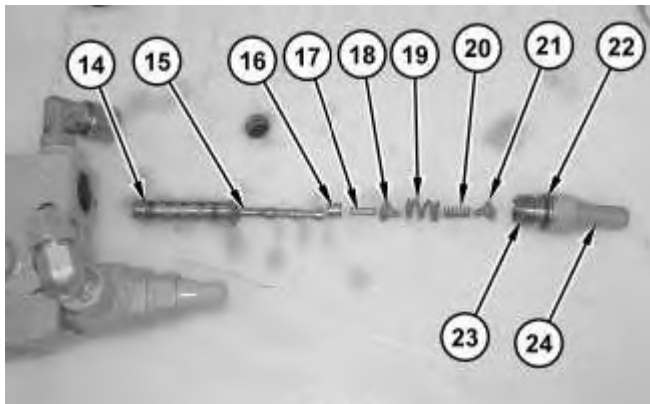

Illustration 6

g01247151



Personal injury can result from being struck by parts propelled by a released spring force.

Make sure to wear all necessary protective equipment.

Follow the recommended procedure and use all recommended tooling to release the spring force.

6. Remove cap (24), plug (23), O-ring seal (22), spring retainer (21), spring (20), spring (19), spring retainer (18), pin (17), spacer (16), spool (15), and housing (14).

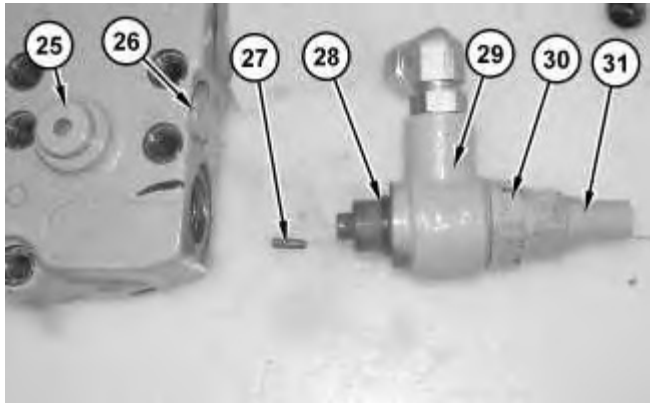

Illustration 7

g01247258

7. Remove plug (25) and plug (26).
8. Remove cap (31), plug (30), O-ring seal (28), fitting (29), and pin (27).

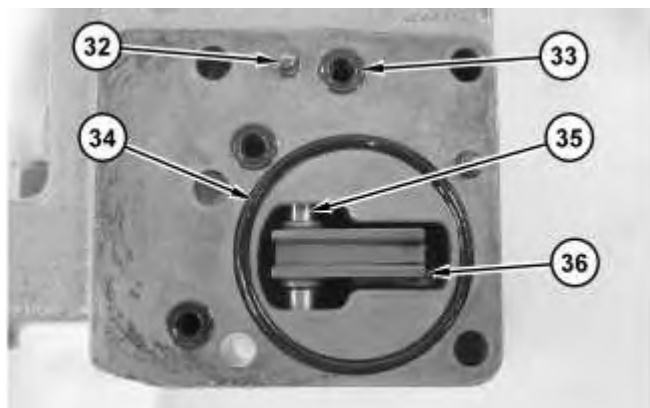

Illustration 8

g01247262

9. Remove pins (32), O-ring seals (33), O-ring seal (34), pin (35), and lever (36).

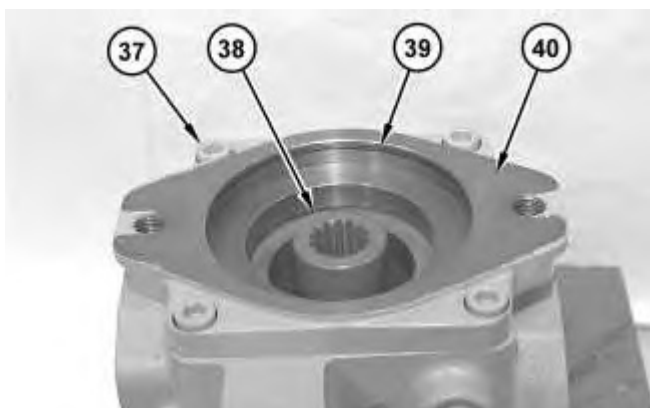

Illustration 9

g01173603

10. Remove coupling (38), O-ring seal (39), bolts (37), and flange (40).

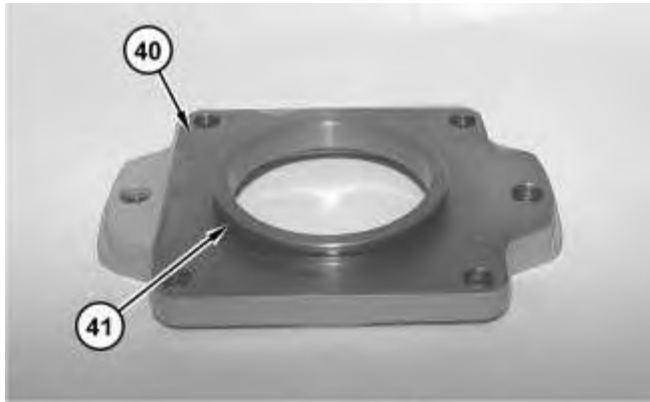

Illustration 10

g01173605

11. Remove O-ring seal (41) from flange (40).

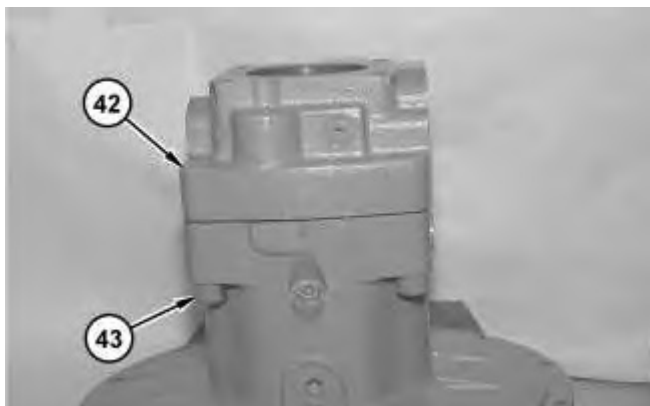

Illustration 11

g01173606

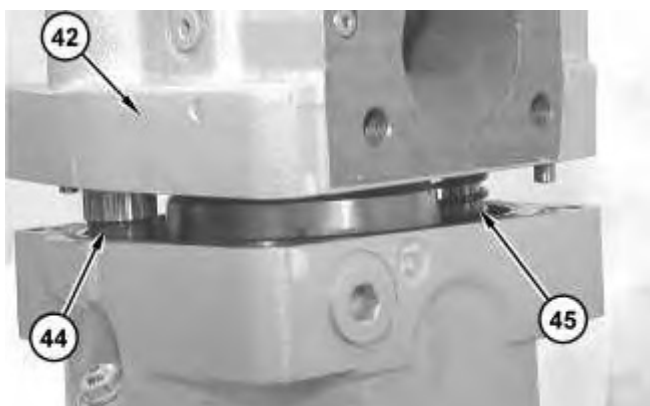

Illustration 12

g01173608



WARNING

Personal injury can result from being struck by parts propelled by a released spring force.

Thank you so much for reading.
Please click the “Buy Now!”
button below to download the
complete manual.



After you pay.

You can download the most
perfect and complete manual in
the world immediately.

Our support email:

ebooklibonline@outlook.com