

JOHN DEERE
WORLDWIDE COMMERCIAL & CONSUMER
EQUIPMENT DIVISION

Winch

OMM161330 D0

OPERATOR'S MANUAL



JOHN DEERE

Original Instruction

All information, illustrations and specifications in this manual are based on the latest information at the time of publication. The right is reserved to make changes at any time without notice.

**COPYRIGHT© 2010
Deere & Co.**

**John Deere Worldwide Commercial and
Consumer Equipment Division**

**All rights reserved
Previous Editions
COPYRIGHT© 2010**

**North American Version
Litho in U.S.A.**

INTRODUCTION

Table of Contents

Introduction.....	1
Product Identification.....	1
Safety Labels.....	2
Safety.....	3
Assembly.....	5
Preparing Vehicle.....	6
Installing.....	10
Operating.....	12
Service.....	18
Troubleshooting.....	19
Specifications.....	19
Getting Quality Service.....	19

Introduction

Using Your Operator's Manual

Read this entire operator's manual, especially the safety information, before operating.

This manual is an important part of your machine. Keep all manuals in a convenient location so they can be accessed easily.

Use the safety and operating information in the attachment operator's manual, along with the machine operator's manual, to operate and service the attachment safely and correctly.

If your attachment manual has a section called Preparing the Machine, it means that you will have to do something to your tractor or vehicle before you can install the attachment. The Assembly and Installation sections of this manual provide information to assemble and install the attachment to your tractor or vehicle. Use the Service section to make any needed adjustments and routine service to your attachment.

If you have any questions or concerns with the assembly, installation, or operation of this attachment, see your local John Deere dealer or call the John Deere Customer Contact Center at 1-800-537-8233 for assistance.

Warranty information on this John Deere attachment can be found in the warranty that came with your John Deere tractor or vehicle.

Product Identification

Product Compatibility

The Winch is designed for use with XUV 625i, XUV 825i and XUV 855D Gator™ Utility Vehicles.

Record Purchase Information

Record your purchase information in the spaces provided below.

DATE OF PURCHASE:

DEALER NAME:

DEALER PHONE:

SAFETY LABELS

Safety Label Location

Safety Labels

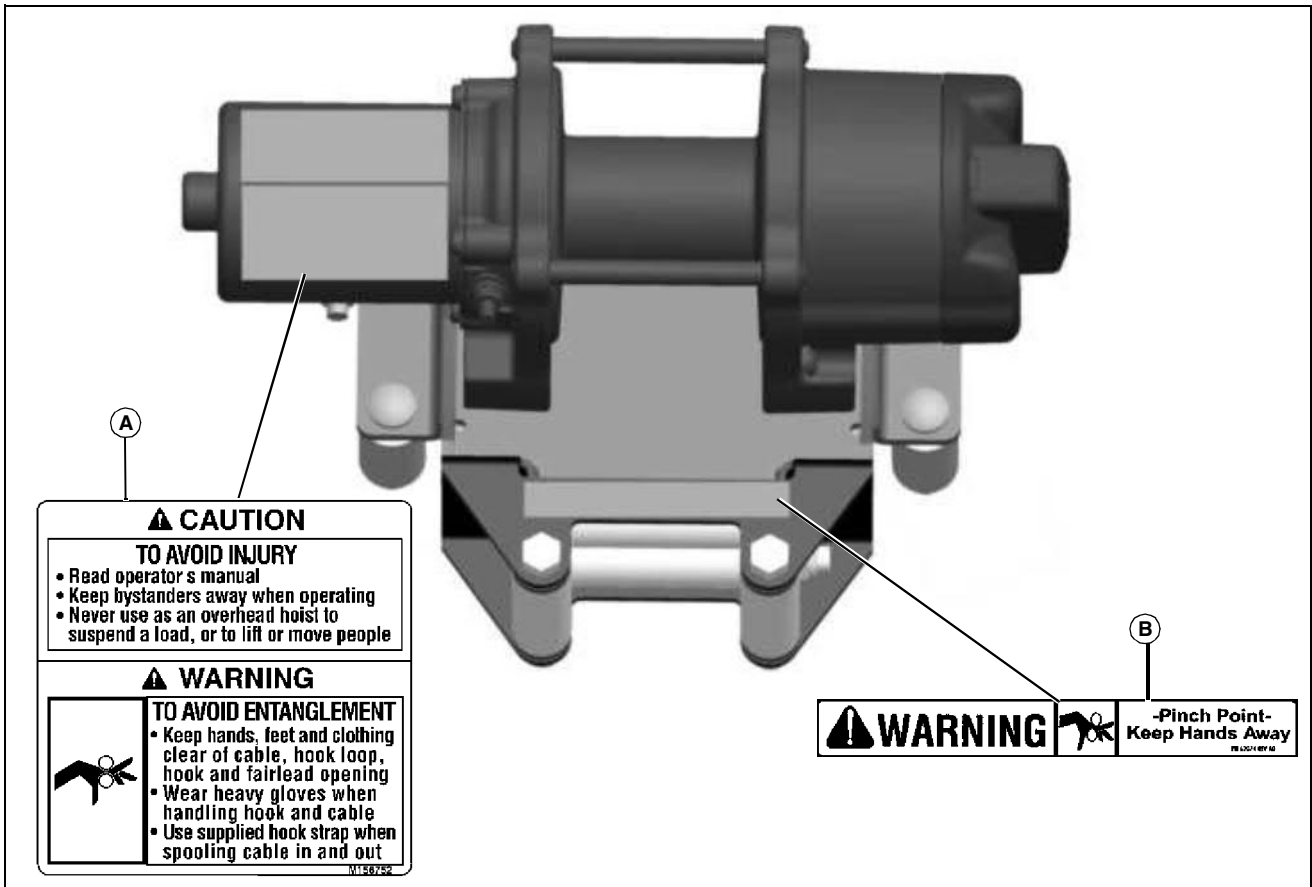

⚠ CAUTION

TO AVOID INJURY

- Read operator's manual
- Keep bystanders away when operating
- Never use as an overhead hoist to suspend a load, or to lift or move people

⚠ WARNING

TO AVOID ENTANGLEMENT



- Keep hands, feet and clothing clear of cable, hook loop, hook and fairlead opening
- Wear heavy gloves when handling hook and cable
- Use supplied hook strap when spooling cable in and out

M156752

⚠ WARNING  **-Pinch Point-Keep Hands Away**

PG.103/REV.02

MX44103

WARNING VG10910

Picture Note: Use label number listed in table below to locate complete text of safety label message following this illustration.

A- M156752 Caution/Warning

B- VG10910 Warning



VG10910

Pinch Point

- Keep Hands Away

CAUTION M156752

⚠ CAUTION

TO AVOID INJURY

- Read operator's manual
- Keep bystanders away when operating
- Never use as an overhead hoist to suspend a load, or to lift or move people

M156752



Understanding The Machine Safety Labels

The machine safety labels shown in this section are placed in important areas on your machine to draw attention to potential safety hazards.

On your machine safety labels, the words DANGER, WARNING, and CAUTION are used with this safety-alert symbol. DANGER identifies the most serious hazards.

The operator's manual also explains any potential safety hazards whenever necessary in special safety messages that are identified with the word, CAUTION, and the safety-alert symbol.

There can be additional safety information contained on parts and components sourced from suppliers that is not reproduced in this operator's manual.

SAFETY

TO AVOID INJURY

- Read operator's manual
- Keep bystanders away when operating
- Never use as an overhead hoist to suspend a load, or to lift or move people

WARNING M156752



M156752

TO AVOID ENTANGLEMENT

- Keep hands, feet and clothing clear of cable, hook loop, hook and fairlead opening
- Wear heavy gloves when handling hook and cable
- Use supplied hook strap when spooling cable in and out

Safety

Read Safety in Machine Operator's Manual

Read the general safety operating precautions in your machine operator's manual for additional safety information.

Operating Safely

- Read, understand and follow all instructions and safety information in the manuals and on the winch before operating.
- Inspect equipment before you operate. Be sure hardware is tight. Repair or replace damaged, badly worn, or missing parts.
- Use and become familiar with the winch before you actually need it in an emergency situation.

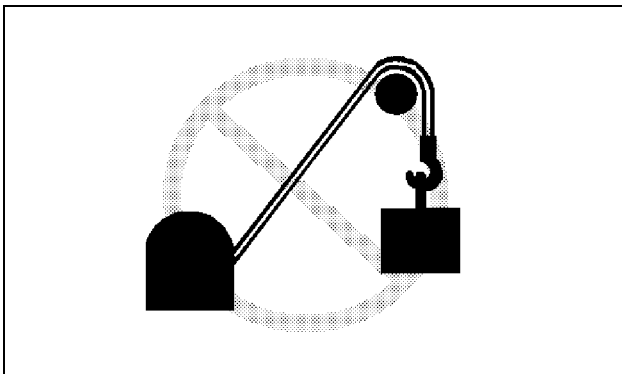

MX8316

- Never use winch for towing or hoisting. A winch is not designed for such

service. A sudden shock load can cause the cable or drum to break.

- Never exceed the rated winch capacity. Do not drive the vehicle to assist with pulling a load attached to the winch. This could overload the drum or cable.
- Make sure tackle such as hooks, pulley blocks, and straps are sized appropriately for the job. Use only factory approved remote controls and accessories.

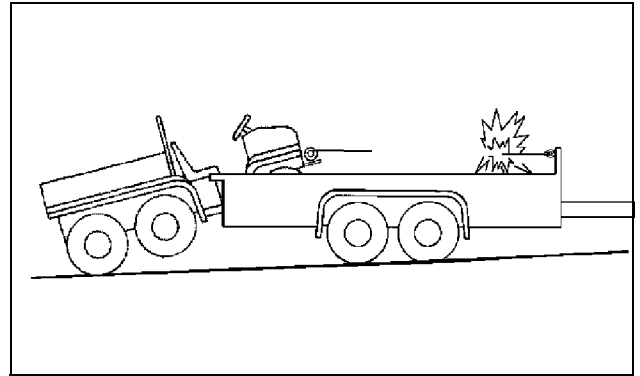

MX8317

- Do not use winch to secure a load during transport.
- Only allow responsible adults, who are familiar with the instructions to operate the winch.
- Always stand clear of the cable and load and keep others away when winching. If cable breaks or pulls loose under load, it can backlash with great force.
- Lay a heavy blanket or jacket over the winch line near the hook end when pulling heavy loads. This will act as a damper to help prevent cable backlash in the event of an equipment failure.

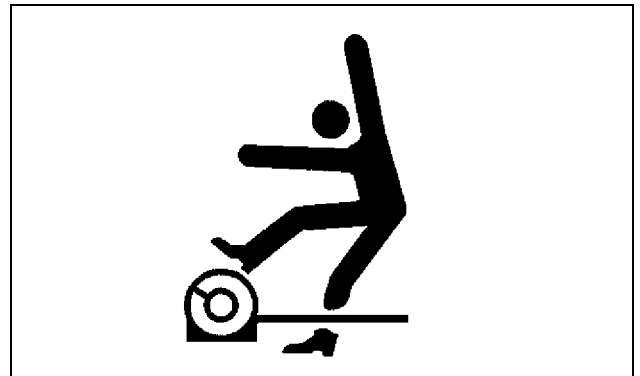

MX8315

- Never step over the cable, even if it is not under tension.
- Only use a 12 volt DC power source to operate your winch. Other power sources can result in fatal shock or damage to the winch.
- Never allow the winch to become submerged in water.
- Always operate winch with an unobstructed view of the winching operation.
- Stop the winching operation if anyone enters the area.

SAFETY

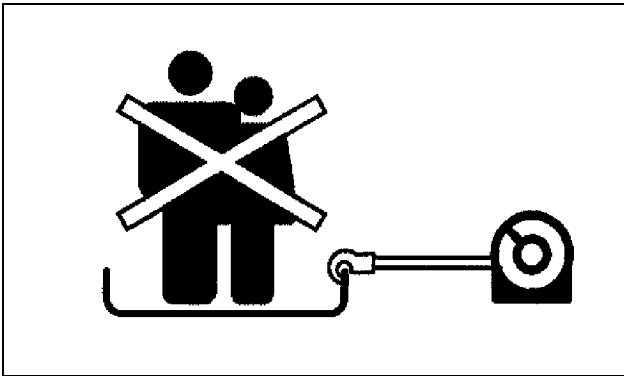

MX8314

- Do not use winch to move persons.
- Never hold the winch cable hook with your hand when rewinding the cable. Hand or fingers can become crushed. Use the hook strap provided.
- Disconnect the winch power cord before leaving machine unattended.
- Only operate during daylight or with good artificial light.
- Never operate winch while under the influence of drugs or alcohol.
- Do not wear radio or music headphones while winching. Safe operation requires your full attention.

Parking Safely

1. Stop vehicle on a level surface, not on a slope.
2. Lock park brake.
3. Stop engine.
4. Remove key.
5. Before you leave the operator's seat, wait for engine and all moving parts to stop.
6. Disconnect the negative battery cable or remove the spark plug wire (for gasoline engines) before servicing the machine.

Practice Safe Maintenance



MIF

- Disengage all power and stop vehicle engine before servicing. Lock park brake and remove the key. Let machine cool.
- Disconnect the winch power leads from battery before servicing to prevent accidental start-up of the winch.
- Understand service procedure before doing work. Keep area clean and dry.
- Use only factory approved parts for repairs.

- Never work on or around the winch when drum is under load. Keep safety devices in place and in working condition. Keep hardware tight.
- Keep hands, feet, clothing, jewelry, and long hair away from any moving parts, to prevent them from getting caught.
- Inspect winching tackle regularly for damage.
- Keep all parts in good condition and properly installed. Fix damage immediately. Replace worn or broken parts. Remove any buildup of debris.
- Never attempt repairs while under the influence of drugs or alcohol.
- Do not wear radio or music headphones while servicing the machine. Safe service requires your full attention.

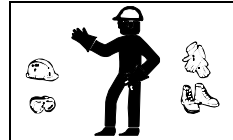

Wear Appropriate Clothing

- Wear close fitting clothing and safety equipment appropriate for the job.
- Always wear heavy gloves when handling the winch cable.

Do Not Modify Machine

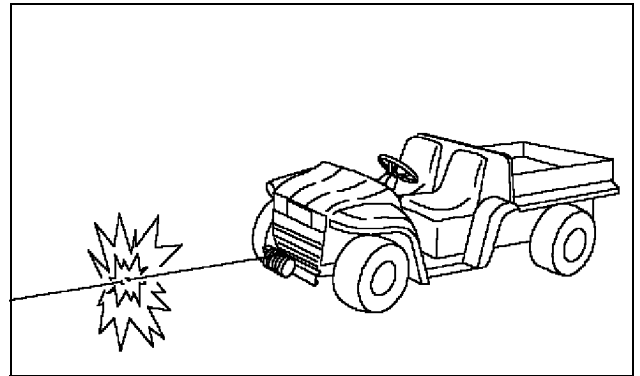

MX8306

- Never machine, weld, or make any unauthorized modifications to any part of the winch, carrier plate, cable, or receiver.
- Never alter or remove the safety decals.
- Modifications can result in making the winch unsafe, increasing the possibility of severe bodily injury or death.

Thank you so much for reading.
Please click the “Buy Now!”
button below to download the
complete manual.



After you pay.

You can download the most
perfect and complete manual in
the world immediately.

Our support email:

ebooklibonline@outlook.com