

100A

CLAAS

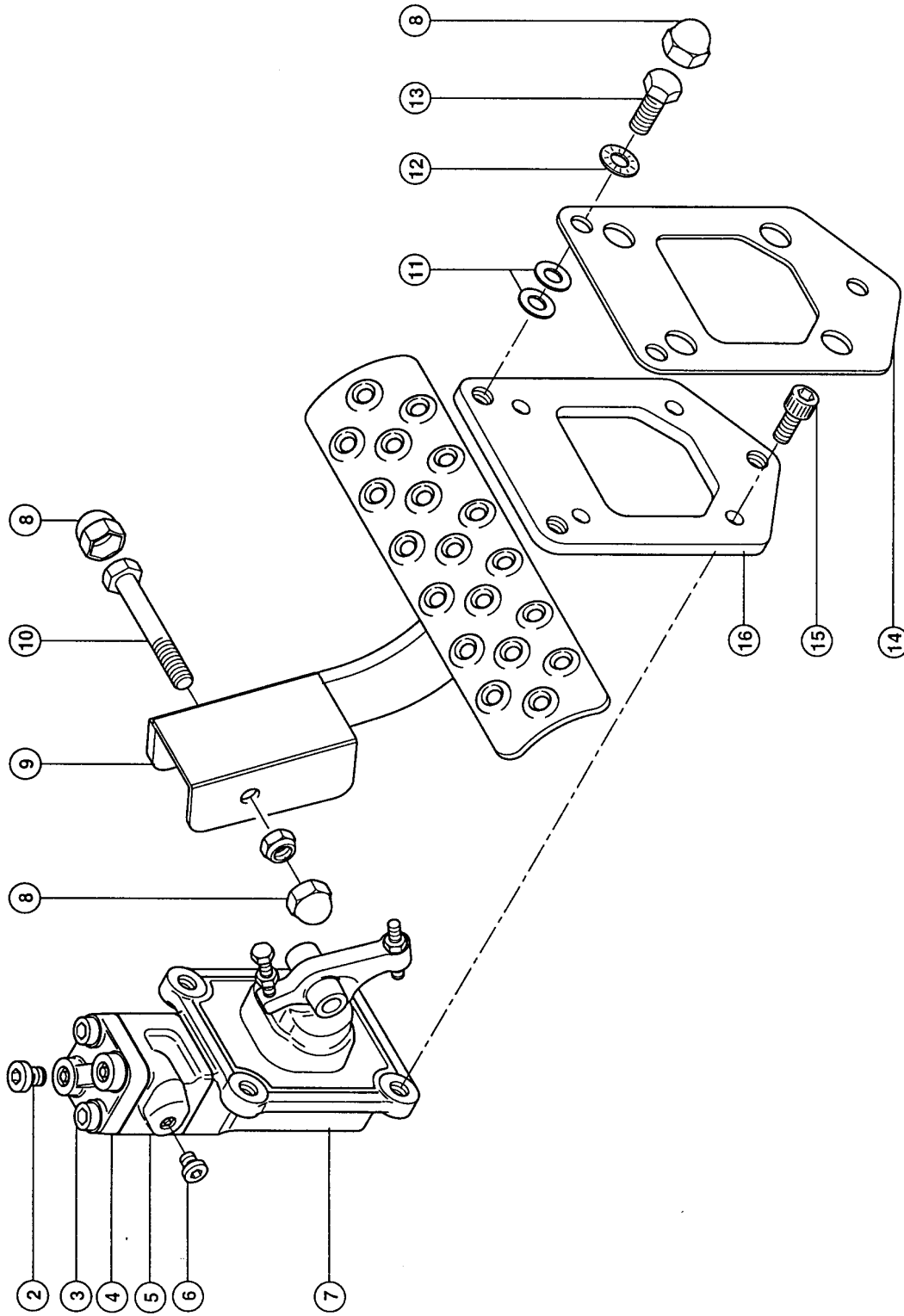

15146z00
TARGO K-SERIE

EG2079-1

134722

BRAKE PEDAL CPL., SINGLE CIRCUIT

Pos.	Part No.	Description	Dimension	Quantity	Conditions
1	00 0349 529 0	BRAKE PEDAL ASSEMBL.	SINGLE	1	
2	00 0211 130 0	SCREW PLUG	M14X1,5	1	
3	00 0349 637 0	SCREW	M08X75	2	
4	00 0349 639 0	FLANGE		1	
5	00 0349 640 0	BRAKING MODULE		1	
6	00 0237 046 0	SCREW PLUG	M10X1	1	
7	00 0349 642 0	PEDAL LEVER		1	
8	00 0215 220 0	GUARD CAP	SW17-M10-GPN 1000	5	
9	00 0349 624 0	PEDAL		1	
10	00 0235 538 0	HEXAGON HEAD BOLT	M10X70	1	
10	00 0238 316 0	LOCK NUT	M10	1	
11	00 0236 913 2	FLAT WASHER	10-10,5X20X2	6	
12	00 0239 388 0	CONTACT WASHER	A10-10,2X22,25X1,6	3	
13	00 0237 453 0	HEXAGON HEAD BOLT	M10X30	3	
14	00 0349 490 1	BRAKE BASE	3MM	1	
15	00 0244 359 0	SOCKET HEAD SCREW	M 8X 20	4	
16	00 0349 476 1	BRAKE BASE	5MM	1	
16	00 0349 625 0	SEAL KIT	F. 0349 529.0	1	

102A

CLAAS

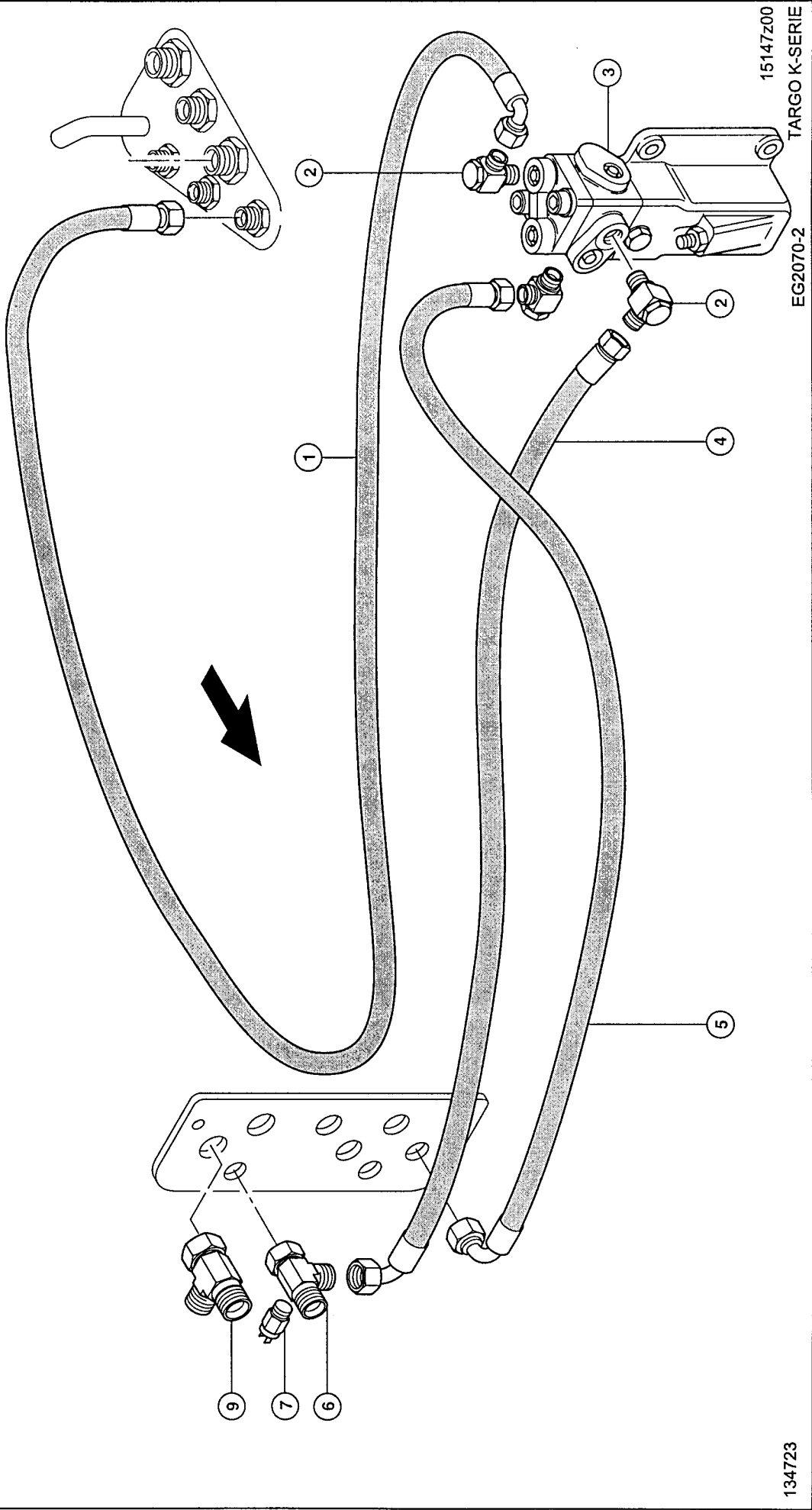

BRAKE LINES, SINGLE CIRCUIT

Pos.	Part No.	Description	Dimension	Quantity	Conditions
1	00 0349 583 0	HYDR. HOSE	W.ERS.D.0349 583.1	1	
2	00 0349 502 0	SCREWING	W.ERS.D. 238 982.1	3	
3	00 0349 477 0	BRAKE VALVE		1	
4	00 0349 540 0	HYDR. HOSE		1	
5	00 0349 540 0	HYDR. HOSE		1	
6	00 0317 677 0	T-PIECE	SWORT-L10 MOD. 1/8 NPTF	1	
7	00 0320 619 1	PRESSURE SWITCH		1	
9	00 0249 868 0	T-UNION, ADJUSTM.	SWORT-L15	1	

103A

CLAAS

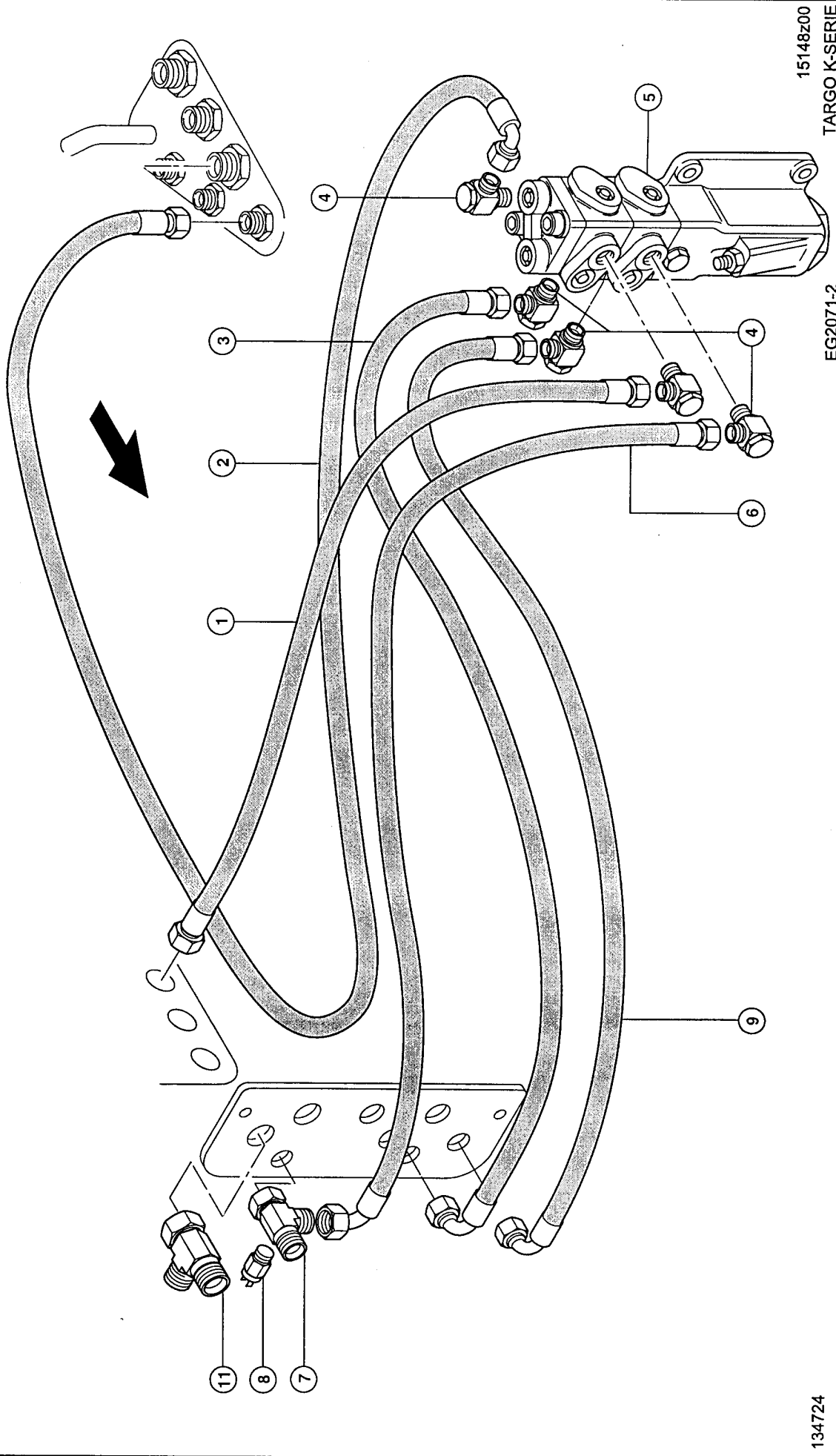

15148z00
TARGO K-SERIE

EG2071-2

134724

BRAKE LINES, DUAL CIRCUIT

Pos.	Part No.	Description	Dimension	Quantity	Conditions
1	00 0349 541 0	HYDR. HOSE		1	
2	00 0349 583 0	HYDR. HOSE	W.ERS.D.0349 583.1	1	
3	00 0349 540 0	HYDR. HOSE		2	
4	00 0349 502 0	SCREWING	W.ERS.D. 238 982.1	5	
5	00 0349 478 0	BRAKE VALVE		1	
6	00 0349 540 0	HYDR. HOSE		1	
7	00 0317 677 0	T-PIECE	SWORT-L10 MOD. 1/8 NPTF	1	
8	00 0320 619 1	PRESSURE SWITCH		1	
9	00 0349 540 0	HYDR. HOSE		1	
11	00 0249 868 0	T-UNION, ADJUSTM.	SWORT-L15	1	

104

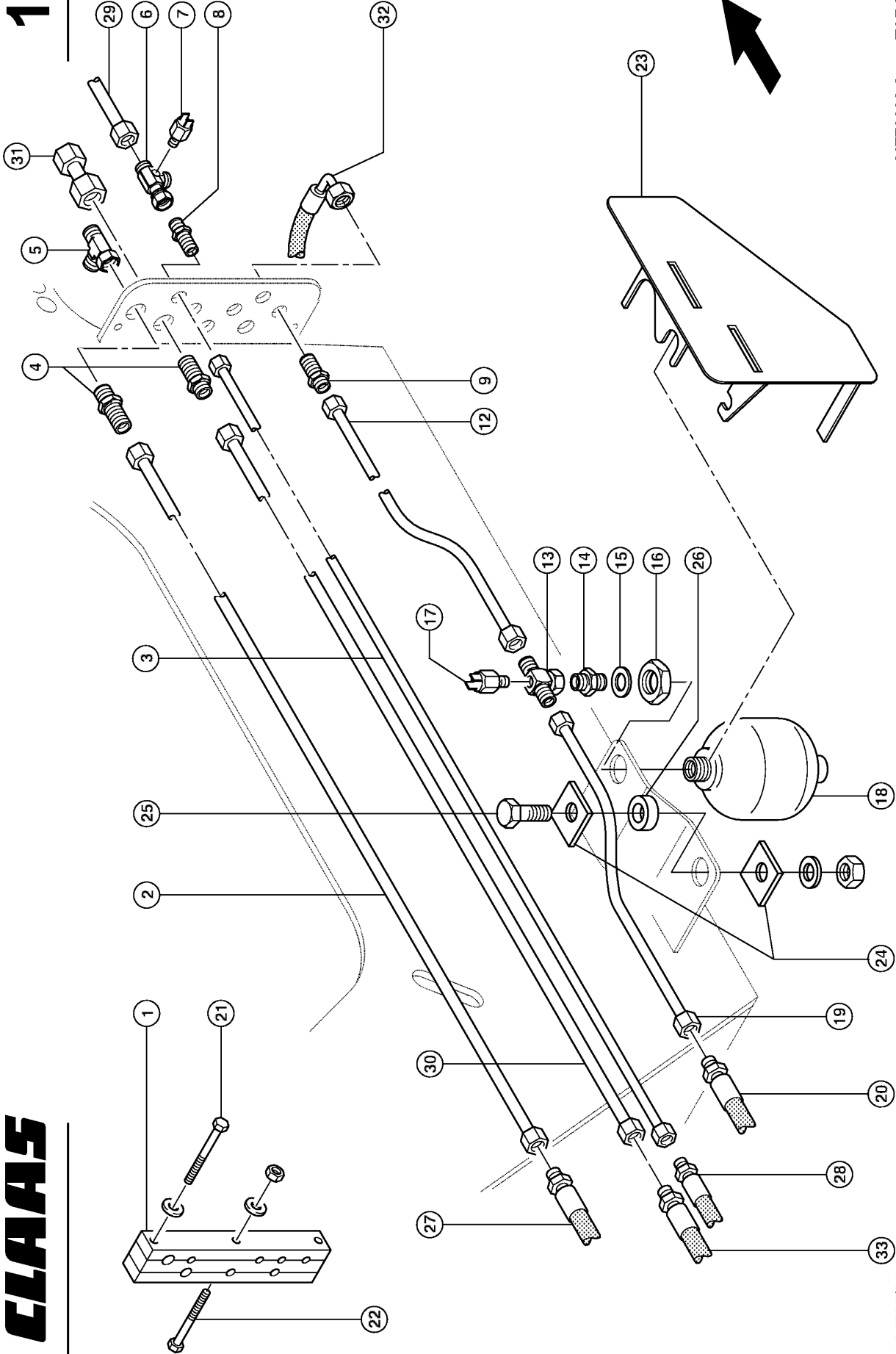

CLAAS

15149z01

MZ70098-8 TARGO K-SERIE

134725/01

BRAKE LINES, SINGLE CIRCUIT

Pos.	Part No.	Description	Dimension	Quantity	Conditions
1	00 0317 501 1	PIPE CLAMP		1	
2	00 0317 510 0	PIPE	L15	1	
3	00 0317 490 0	PIPE	10X1X1400-0	1	
4	00 0211 551 0	SUPPORT	BHS L15	2	
5	00 0249 868 0	T-UNION, ADJUSTM.	SWORT-L15	1	
6	00 0317 677 0	T-PIECE	SWORT-L10 MOD. 1/8 1 NPTF	1	
7	00 0320 619 1	PRESSURE SWITCH		1	
8	00 0249 752 0	SOCKET	BHS-L12	1	
9	00 0239 082 0	STRAIGHT CONNECTOR	BHS-L10	1	
12	00 0317 507 0	PIPE	10X1X987-2	1	
13	00 0317 679 0	T-PIECE	SWOBT-L10 MOD. 1/8NPTF	1	
14	00 0216 010 0	SCREW-IN FITTING	SDS-L10XG1/2A-TYPE E	1	
15	00 0217 004 0	SEALING WASHER	21,54X28,58X2, 47-G1/2 BS	1	
16	00 0215 356 0	HEXAGONAL NUT	M33X1,5	1	
17	00 0315 493 1	LOW PRESS.SWITCH		1	
18	00 0323 884 0	ACCUMULATOR	0,75L 210BAR	1	
19	00 0317 506 0	PIPE	10X1X296-2	1	
20	00 0318 374 2	HYDR. HOSE	1SN6	1	
21	00 0238 522 0	STUD BOLT	M10X 70	2	
21	00 0239 387 0	CONTACT WASHER	A8-8,2X18X1,4	3	
22	00 0237 854 0	HEXAGON HEAD BOLT	M8X55	2	
22	00 0237 170 0	PLUG IN KEY	B 27X30	1	
23	00 0325 793 1	GUARD		1	
24	00 0325 808 1	SUPPORTING PLATE		2	
25	00 0237 462 0	HEXAGON HEAD BOLT	M12X40	1	
25	00 0236 172 0	HEXAGONAL NUT	M12	1	
25	00 0239 389 0	CONTACT WASHER	A12	1	
26	00 0325 809 0	SPACER		1	
27	00 0317 542 1	HYDR. HOSE	2SC 12 N90D 2610	1	
28	00 0317 575 1	HYDR. HOSE	2SC 8 N90D 820	1	
29	00 0317 489 0	PIPE	L10	1	
30	00 0317 509 0	PIPE	15X1,5X1405-0	1	
31	00 0216 109 0	SCREWING	SWOS-L15	1	
32	00 0349 540 0	HYDR. HOSE		1	
33	00 0317 573 1	HYDR. HOSE		1	

105

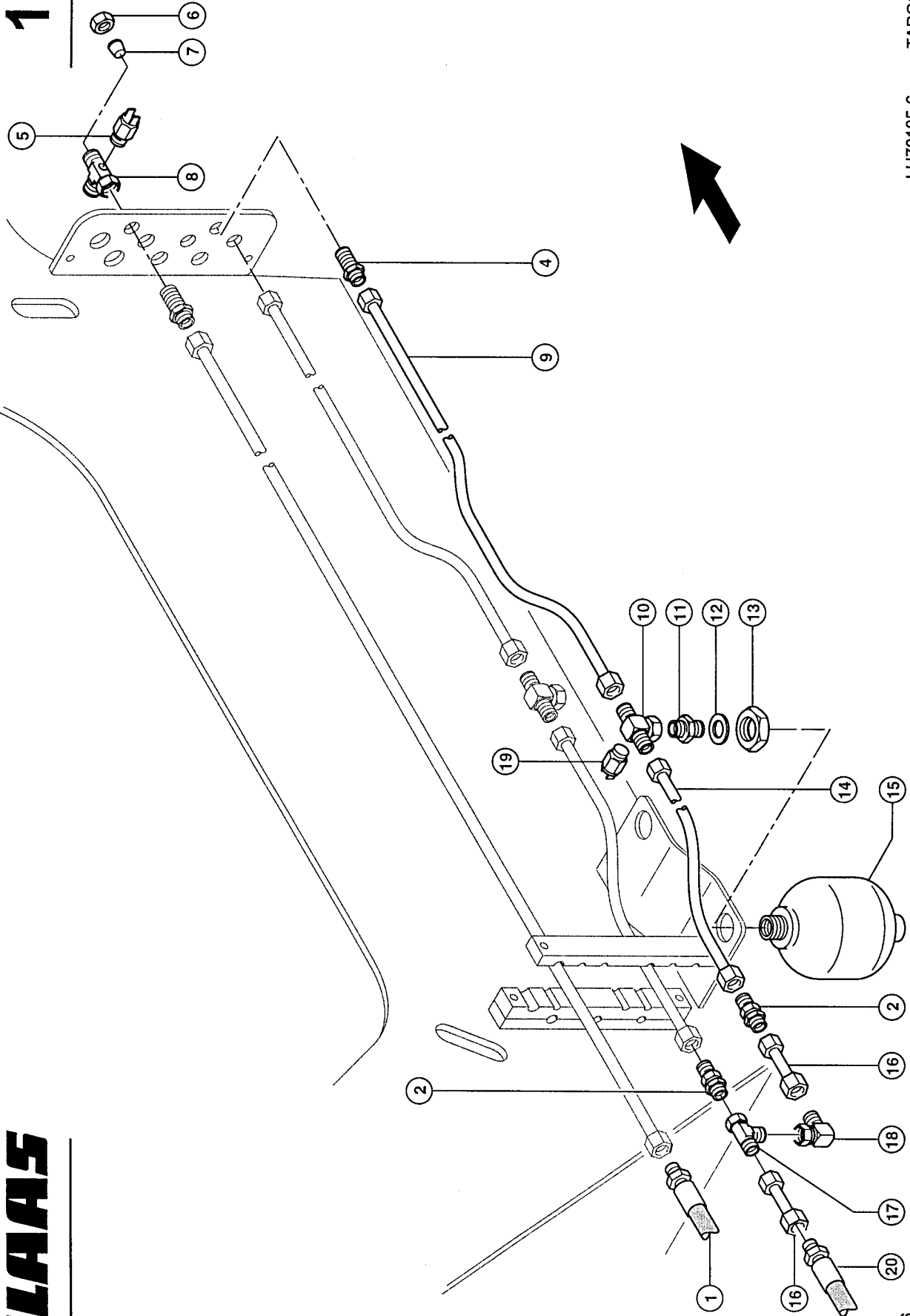

15150z00
TARGO K-SERIE
LH70105-6

CLAAS

134726

BRAKE LINES, DUAL CIRCUIT

Pos.	Part No.	Description	Dimension	Quantity	Conditions
1	00 0317 575 1	HYDR. HOSE	2SC 8 N90D 820	1	
2	00 0690 000 0	THROTTLE ASS.		1	
4	00 0239 082 0	STRAIGHT CONNECTOR	BHS-L10	1	
5	00 0320 619 1	PRESSURE SWITCH		1	
6	00 0215 482 0	UNION NUT	A3 L10	1	
7	00 0215 088 1	PLUG	PL-L10	1	
8	00 0317 677 0	T-PIECE	SWORT-L10 MOD. 1/8 1 NPTF	1	
9	00 0317 663 0	PIPE	10X1,5X??--4	1	
10	00 0317 679 0	T-PIECE	SWOBT-L10 MOD. 1/8NPTF	1	
11	00 0216 010 0	SCREW-IN FITTING	SDS-L10XG1/2A-TYPE E	1	
12	00 0217 004 0	SEALING WASHER	21,54X28,58X2, 47-G1/2 BS	1	
13	00 0215 356 0	HEXAGONAL NUT	M33X1,5	1	
14	00 0317 664 0	PIPE	10X1,5X??--2	1	
15	00 0323 884 0	ACCUMULATOR	0,75L 210BAR	1	
16	00 0216 093 0	UNION	SWOS-L10	1	
17	00 0249 866 0	L-UNION	W.ERS.D.2388900	1	
18	00 0249 834 0	ANGLE SUPPORT	W.ERS.D.2386930	1	
19	00 0315 493 1	LOW PRESS.SWITCH		1	
20	00 0318 374 2	HYDR. HOSE	1SN6	1	

106D

CLAAS

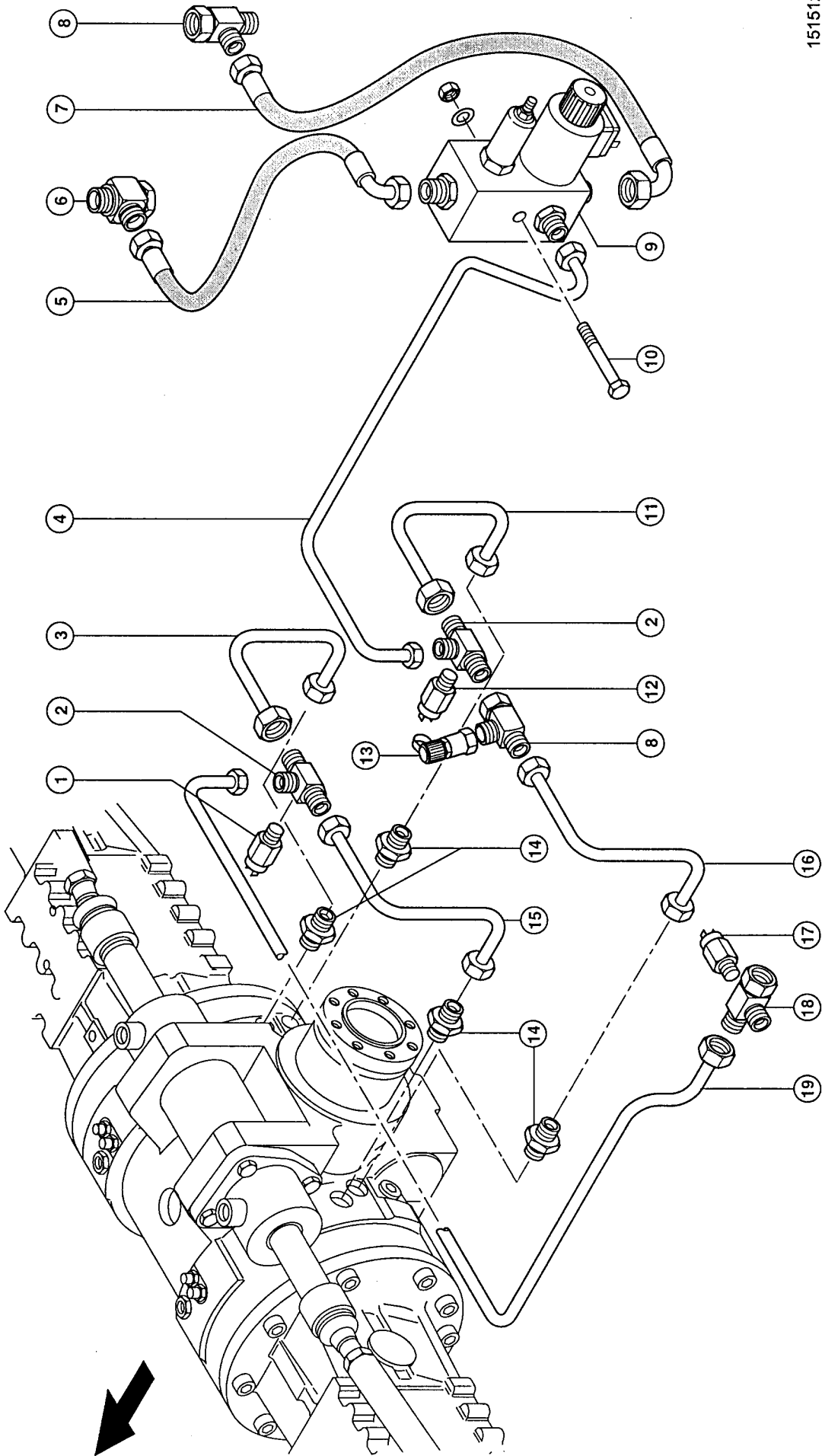

15151z00
TARGO K-SERIE

EG2074

134727

BRAKE PIPES, FRONT AXLE, SINGLE CIRCUIT

Pos.	Part No.	Description	Dimension	Quantity	Conditions
1	00 0315 492 1	PRESSURE SWITCH	L=46/ SW 24	1	
2	00 0316 406 0	T-PIECE	T-L10(+1/8NPTF)	2	
3	00 0317 481 0	BRAKE PIPE	10X1X395-2	1	
3	00 0217 040 0	SEALING RING	WF-WD 10 L/S VI	2	
4	00 0349 615 0	PIPE	10X1X658-4	1	
4	00 0217 040 0	SEALING RING	WF-WD 10 L/S VI	2	
5	00 0317 494 1	HYDR. HOSE	1SC6 NN	1	
6	00 0238 982 1	ADJUSTABLE UNION	SWSDE-L10XM14X1, 5-TYPE E	1	
7	00 0317 586 1	HYDR. HOSE	6	1	
7	00 0217 040 0	SEALING RING	WF-WD 10 L/S VI	2	
8	00 0249 866 0	L-UNION	W.ERS.D.2388900	1	
9	00 0040 150 0	BRAKE VALVE		1	
10	00 0237 870 0	HEXAGON HEAD BOLT	M8X75	1	
10	00 0239 387 0	CONTACT WASHER	A8-8,2X18X1,4	1	
10	00 0236 170 0	HEXAGONAL NUT	M8	1	
11	00 0325 821 0	PIPE	10X1X292-2	2	
11	00 0217 040 0	SEALING RING	WF-WD 10 L/S VI	2	
12	00 0317 753 1	PRESSURE SWITCH		1	
13	00 0683 656 1	MEASUREMENT NOZZLE	1215 - L10 (DKO) - M16X1	1	
14	00 0317 721 0	SCREW-IN FITTING	L10F-M10X1	4	
15	00 0317 483 1	BRAKE PIPE	10X1X303-2	1	
15	00 0217 040 0	SEALING RING	WF-WD 10 L/S VI	2	
16	00 0317 482 1	BRAKE PIPE	10X1X303-2	1	
16	00 0217 040 0	SEALING RING	WF-WD 10 L/S VI	2	
17	00 0320 619 1	PRESSURE SWITCH		1	
18	00 0317 677 0	T-PIECE	SWORT-L10 MOD. 1/8 1 NPTF	1	
19	00 0317 489 0	PIPE	L10	1	
19	00 0217 040 0	SEALING RING	WF-WD 10 L/S VI	2	

106E

CLAAS

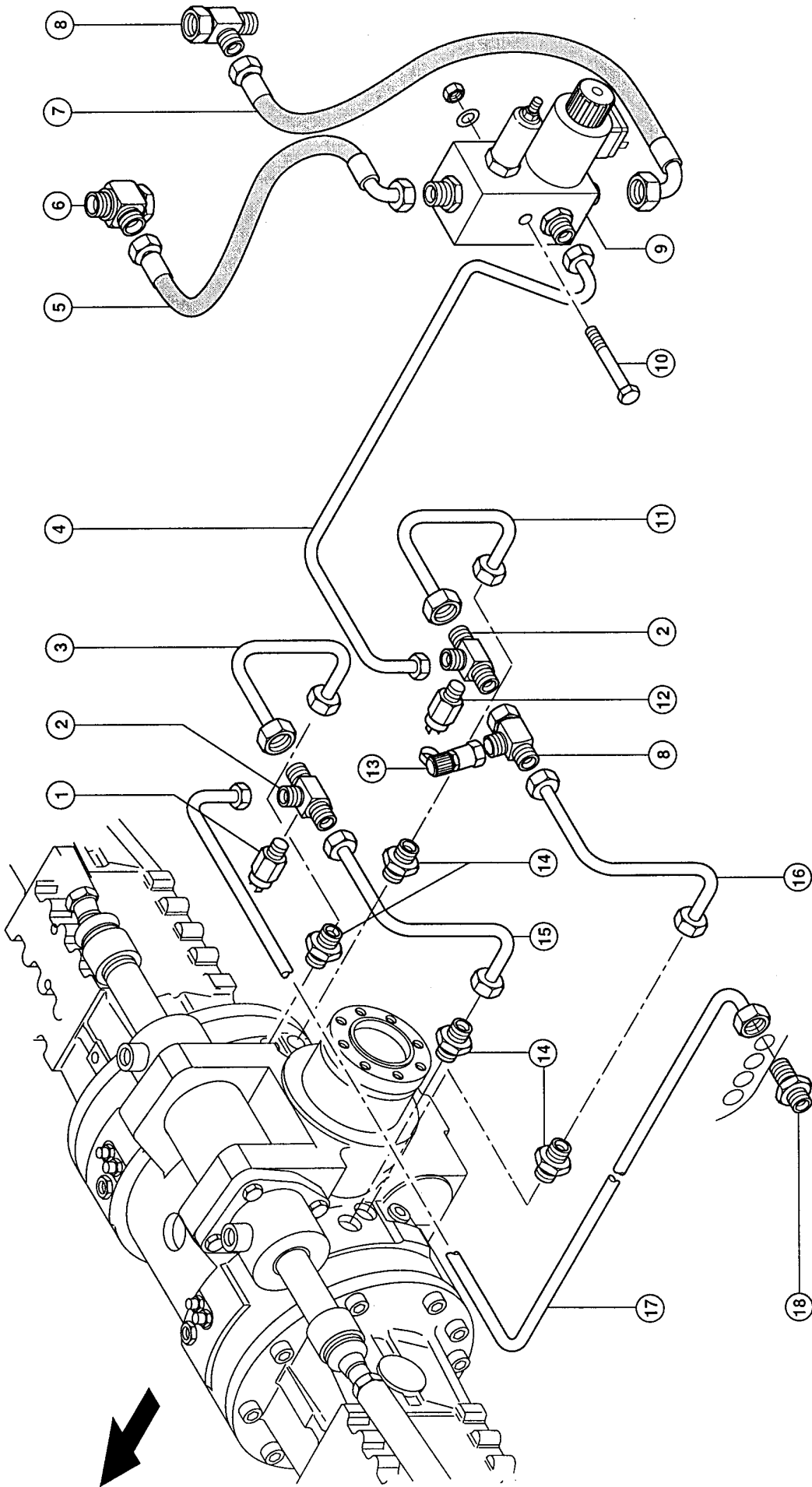

15152z00

TARGO K-SERIE

EG2076-1

134728

Thank you so much for reading.
Please click the “Buy Now!”
button below to download the
complete manual.



After you pay.

You can download the most
perfect and complete manual in
the world immediately.

Our support email:

ebooklibonline@outlook.com