

Section: B0 - ENGINE
CYLINDER HEAD

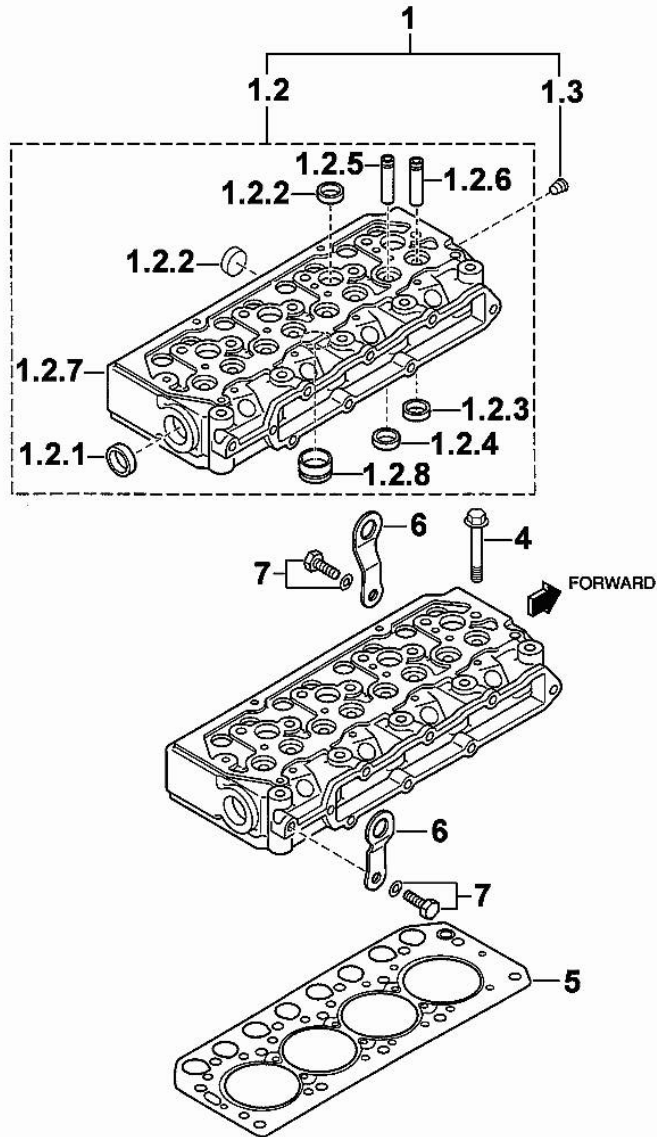

Fig.	P/n	QTY	Name
1	0.010.3986.1	1	engine head
1.2	0.000.0000.1		cannot be supplied
1.2.1	0.010.2634.1	1	plug
1.2.2	0.009.4527.0	7	plug
1.2.3	0.000.0000.1		cannot be supplied
1.2.4	0.000.0000.1		cannot be supplied
1.2.5	0.010.2634.2	4	valve guide
1.2.6	0.010.2635.0	4	valve guide
1.2.7	0.000.0000.1		cannot be supplied
1.2.8	0.010.2636.2	4	special bushing
1.3	0.009.4545.1	1	plug
4	0.010.2633.1	14	screw
5	0.010.2635.2	1	gasket
6	0.009.4541.2	2	bracket
7	0.010.2633.0	2	screw

MIT_H36_003-A-001

01011-001E 47CV

Section: B0 - ENGINE
CYLINDER HEAD

Fig.	P/n	QTY	Name
1	0.010.2637.2	4	inlet valve Ø mm 6.5
2	0.010.2638.0	4	exhaust valve Ø mm 6.5
3	0.010.2638.1	8	spring
4	0.000.0000.1	8	cannot be supplied
5	0.009.4561.2	16	stop
6	0.009.4562.0	8	gasket
7	0.010.2639.0	8	cap
8	0.000.0000.1	1	cannot be supplied
8.1	0.010.2640.1	1	screw
8.2	0.009.4559.0	2	ring
8.3	0.010.3949.0	8	rocker arm
8.3.4	0.010.2641.0	8	nut
8.3.5	0.000.0000.1		cannot be supplied
8.3.6	0.010.3949.1	8	register
8.7	0.010.2644.1	1	shaft
8.7.8	0.010.2643.0	2	plug
8.7.9	0.000.0000.1		cannot be supplied
8.10	0.010.2642.0	1	support
8.11	0.010.2642.1	3	support
8.12	0.010.2643.1	3	spring
8.13	0.010.2643.2	4	screw
9	0.010.2644.0	1	camshaft
10	0.009.4567.0	1	special bearing
11	0.009.4566.0	1	washer
12	0.009.4567.2	1	stick
13	0.010.2639.1	1	screw

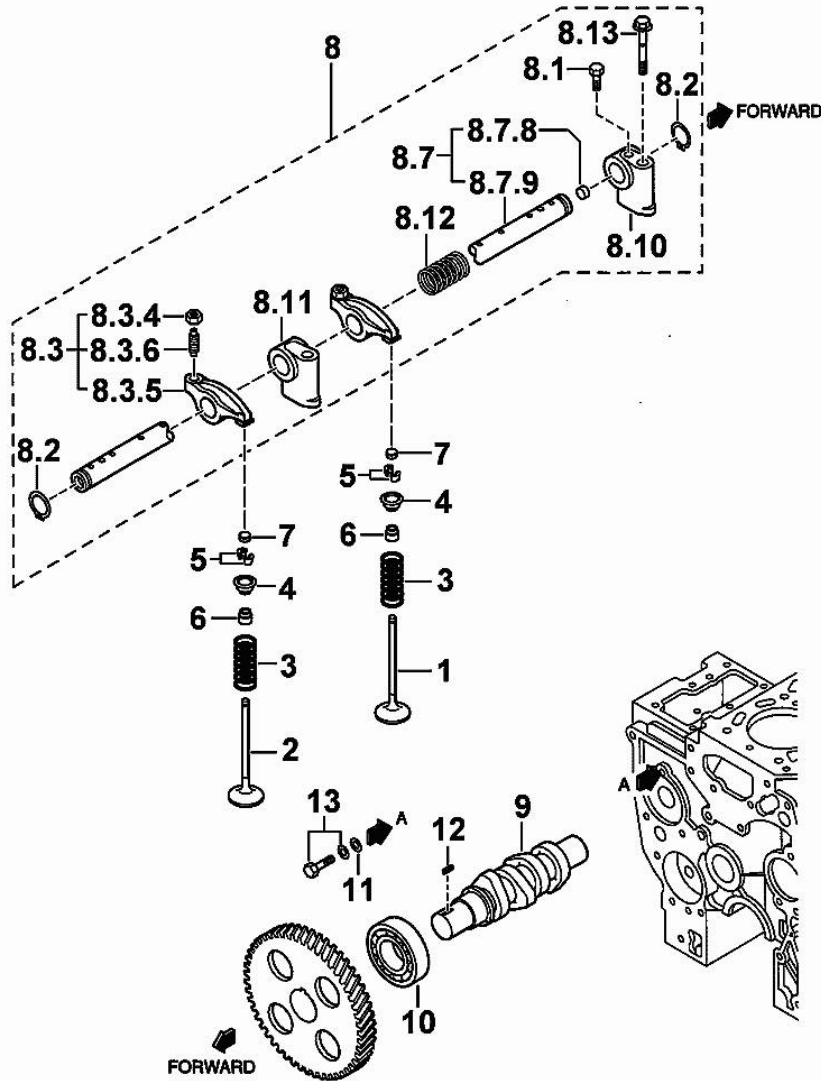

MIT_H36_004-A-001

01021-013E

Section: B0 - ENGINE
CYLINDER HEAD

Fig.	P/n	QTY	Name
1	0.010.2647.1	1	cover
1.1	0.000.0000.1		cannot be supplied
1.2	0.000.0000.1		cannot be supplied
2	0.010.2647.2	1	gasket
3	0.010.2645.2	5	screw
4	0.009.4548.0	1	plug
5	0.009.4781.2	1	tube
6	0.010.2206.0	1	clamp

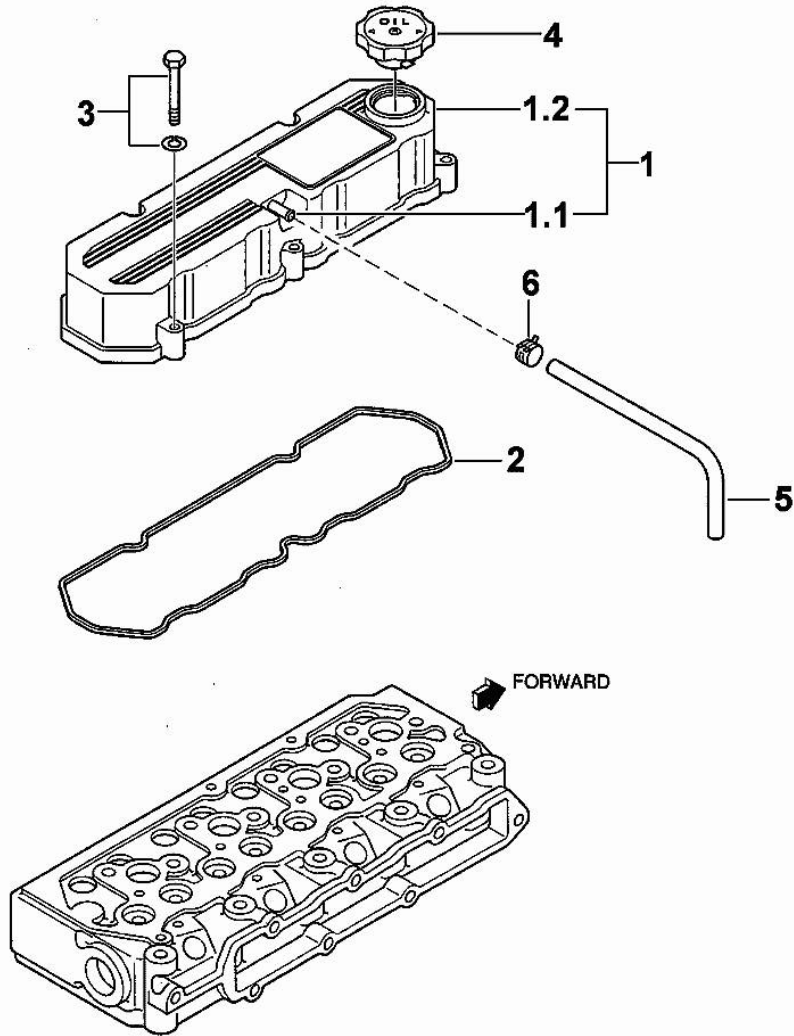

MIT_H36_006-A-001

01031-015E

Section: B0 - ENGINE

CAMSHAFT

Fig.	P/n	QTY	Name
1	0.010.3949.2	1	camshaft
2	0.009.4555.1	1	key
3	0.010.3950.0	1	small plate
4	0.010.2639.1	2	screw
5	0.010.3950.1	8	tappets
6	0.010.2646.2	8	rod

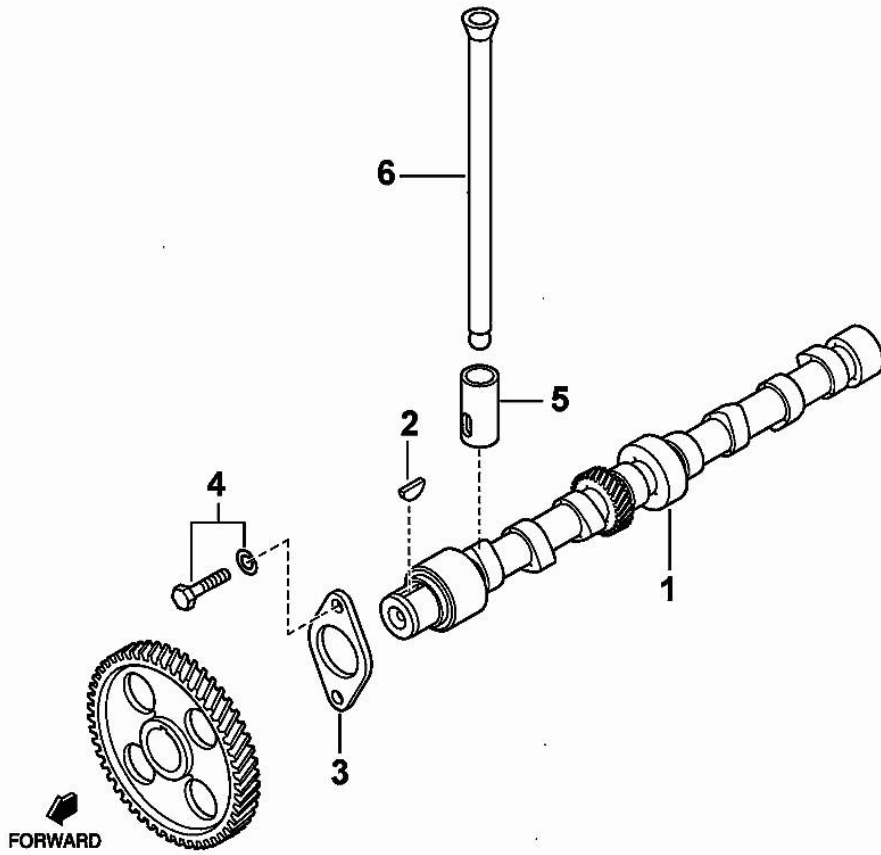

01031-016E

MIT_H36_007-A-001

Section: B0 - ENGINE

CRANKCASE

Fig.	P/n	QTY	Name
1	0.010.3986.2	1	crankcase
1.2	0.000.0000.1		cannot be supplied
1.2.1	0.010.2652.1	3	special bushing
1.2.2	0.010.2652.2	3	special bushing
1.2.3	0.010.2653.0	10	screw
1.2.4	0.010.2653.1	1	special bushing
1.2.5	0.000.0000.1		cannot be supplied
1.2.5.6	0.000.0000.1		cannot be supplied
1.2.5.7	0.000.0000.1		cannot be supplied
1.2.5.8	0.000.0000.1		cannot be supplied
1.2.5.9	0.000.0000.1		cannot be supplied
1.2.5.10	0.000.0000.1		cannot be supplied
1.2.11	0.000.0000.1		cannot be supplied
1.3	0.009.4523.2	1	guide
1.4	0.010.2649.0	1	plug
1.5	0.010.2649.1	3	special bushing
1.6	0.009.4545.1	1	plug
1.7	0.009.4524.2	4	special bushing
1.8	0.009.4525.1	2	special bushing
1.9	0.009.4525.2	1	special bushing
1.10	0.009.4524.1	1	expansion plug
1.11	0.010.3951.0	1	pin
1.12	0.009.4523.0	2	pin
1.13	0.010.2650.0	1	pin
1.13.1	0.010.2650.1	1	ball
1.13.2	0.000.0000.1		cannot be supplied
1.15	0.010.2651.0	2	pin
1.16	0.010.2651.1	1	plug
1.17	0.010.3961.2	4	sprayers
18	0.010.2648.1	4	screw
20	0.010.2651.2	4	gasket

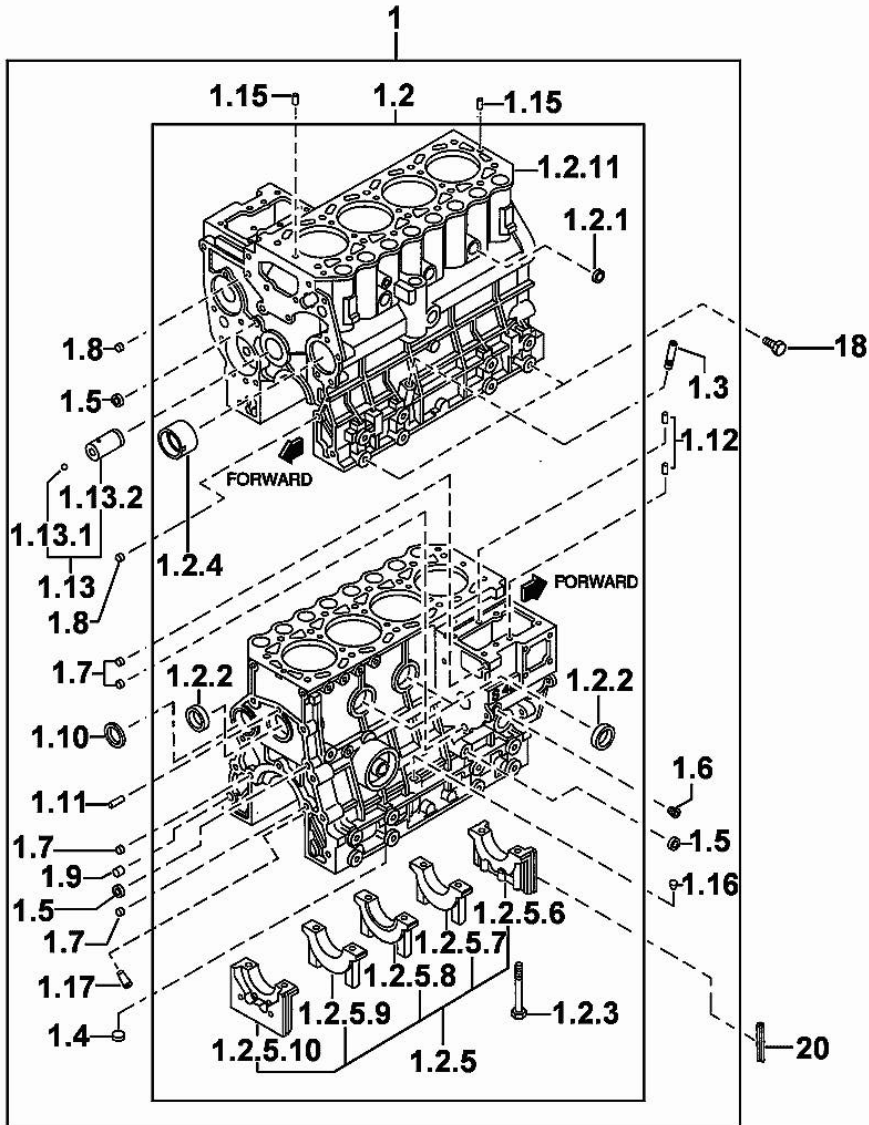

MIT_H36_010-A-001

01041-019E 47CV

Section: B0 - ENGINE

MAIN BEARINGS

Fig.	P/n	QTY	Name
1	0.010.2656.2	1	main half bushing STANDARD
2	0.010.2657.0	1	main half bushing - mm 0.25
3	0.010.2657.1	1	main half bushing - mm 0.50
4	0.010.2657.2	1	main half bushing - mm 0.75

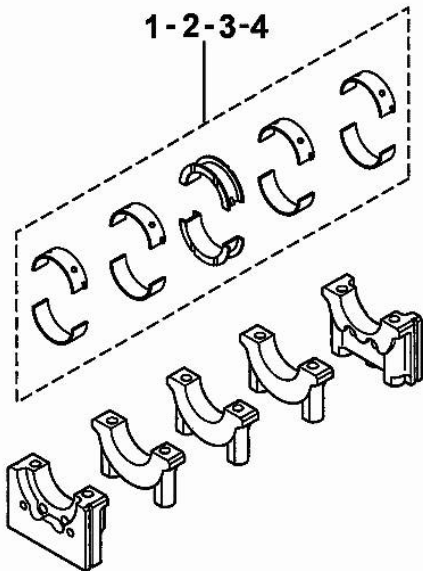
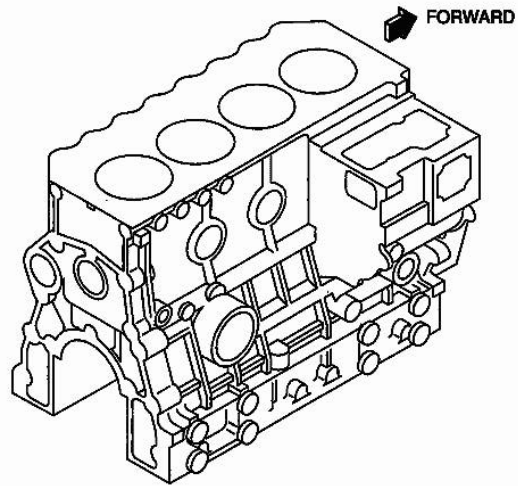

MIT_H36_012-A-001

0104B1-001E

Buy Now



Our support email:

ebooklibonline@outlook.com