

CRANKCASE

Fig.	P/n	QTY	Name
------	-----	-----	------

Notes:

[AGROLUX 60 E 2WD -> D10S553WX1E5001] [AGROLUX 60 E 4WD -> D10S553WT1E5001]

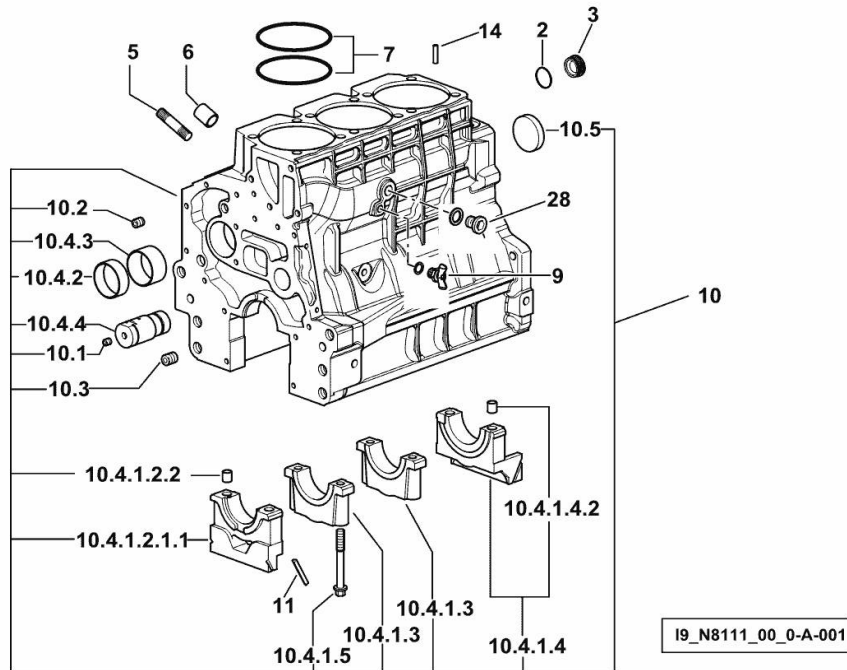

2	2.1532.072.0	1	oil seal 26.70x1.78
3	2.3199.405.2	1	plug m 28 p.1.5
5	2.0432.003.7	11	stud bolt m 8 p.1.25 / p.1 x 20
6	2.1559.188.2	3	bush 11.4 x 14 x16
7	2.1539.259.0	6	special oil seal 107.62x2.62
9	0.049.1152.0	1	cock
10	0.014.8700.4	1	crankcase
10.1	2.3130.001.1	9	plug 1/8" gas
10.2	2.3130.002.1	2	plug 1/4" gas
10.3	2.3130.003.1	2	plug 3/8" gas
10.4.1.2.1.1	0.065.1112.7/10	1	support
10.4.1.2.2	2.1699.165.0	1	bush 12.3x15x16
10.4.1.3	0.065.1114.0/10	2	support
10.4.1.4	0.065.1116.3	1	support
10.4.1.4.2	2.1699.165.0	1	bush 12.3x15x16
10.4.1.5	0.065.1117.0	8	screw m 12 x 100
10.4.2	0.065.1140.0	3	special bushing 59X55X20
10.4.3	0.065.1141.0	1	special bushing 59X55X30
10.4.4	0.014.1340.0	1	pin
10.5	2.3179.012.0	1	plug 60
11	0.066.1152.0/10	4	gasket
14	2.1549.154.2	3	bush 4.8x5.8x16
28	2.3131.004.2	1	plug m 18 p.1.5

CRANKCASE

Fig.	P/n	QTY	Name
------	-----	-----	------

Notes:

[AGROLUX 60 E 2WD -> D10S553WX1E5001] [AGROLUX 60 E 4WD -> D10S553WT1E5001]

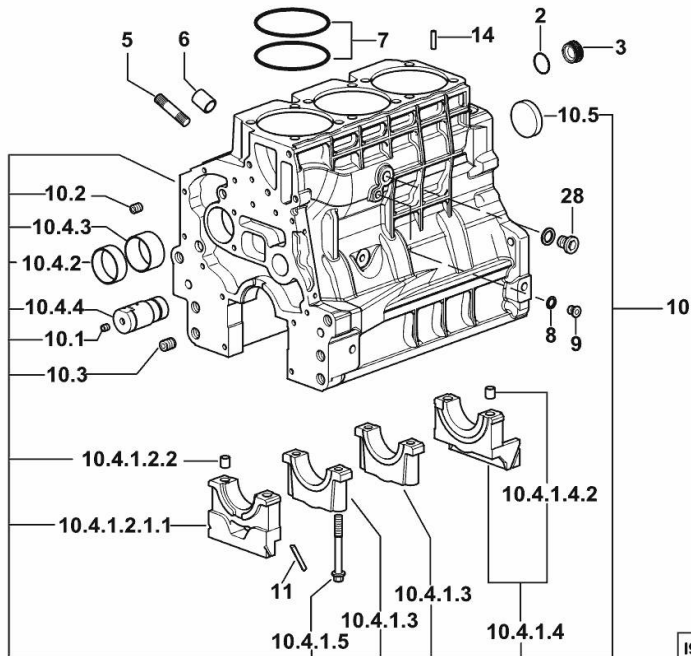

19_N8111_00_0-A-002

2	2.1532.072.0	1	oil seal 26.70x1.78
3	2.3199.405.2	1	plug m 28 p.1.5
5	2.0432.003.7	11	stud bolt m 8 p.1.25 / p.1 x 20
6	2.1559.188.2	3	bush 11.4 x 14 x16
7	2.1539.259.0	6	special oil seal 107.62x2.62
8	2.1560.010.0	1	gasket 14.2 x 20
9	2.3199.292.0	1	plug 1/4" gas
10	0.014.8700.4	1	crankcase
10.1	2.3130.001.1	9	plug 1/8" gas
10.2	2.3130.002.1	2	plug 1/4" gas
10.3	2.3130.003.1	2	plug 3/8" gas
10.4.1.2.1.1	0.065.1112.7/10	1	support
10.4.1.2.2	2.1699.165.0	1	bush 12.3x15x16
10.4.1.3	0.065.1114.0/10	2	support
10.4.1.4	0.065.1116.3	1	support
10.4.1.4.2	2.1699.165.0	1	bush 12.3x15x16
10.4.1.5	0.065.1117.0	8	screw m 12 x 100
10.4.2	0.065.1140.0	3	special bushing 59X55X20
10.4.3	0.065.1141.0	1	special bushing 59X55X30
10.4.4	0.014.1340.0	1	pin
10.5	2.3179.012.0	1	plug 60
11	0.066.1152.0/10	4	gasket
14	2.1549.154.2	3	bush 4.8x5.8x16
28	2.3131.004.2	1	plug m 18 p.1.5

AGROLUX 60 E -> D10S553WT1E5001

Section: B0 - ENGINE

Ref: B0.01.2 (1)

MONOBLOC ENGINE-GEARBOX CONNECTING FLANGE

Fig.	P/n	QTY	Name
------	-----	-----	------

Notes:

[AGROLUX 60 E 2WD -> D10S553WX1E5001] [AGROLUX 60 E 4WD -> D10S553WT1E5001]

1	0.015.8814.0	1	flange
2	2.0112.511.2	8	screw m 14 p.2 x 30
3	2.0432.255.7	2	stud bolt m 12 p.1.75-1.25x25
4	2.1651.912.0	4	cylindrical plug 12x28
5	2.0512.404.7	2	screw

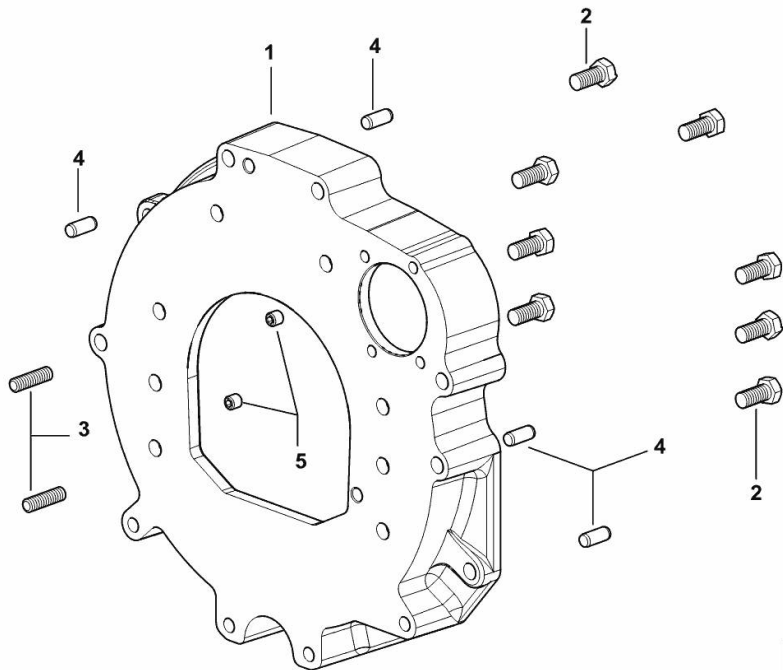

FITTING FOR ENGINE OIL PRESSURE SWITCH

Fig.	P/n	QTY	Name
------	-----	-----	------

Notes:

[AGROLUX 60 E 2WD -> D10S553WX1E5001] [AGROLUX 60 E 4WD -> D10S553WT1E5001]

30	2.1560.008.0	2	gasket 12.2 x 18
31	2.3339.448.2	1	pipe union m 12 p.1.75
32	2.3249.014.2	1	pipe fitting m 12 p.1.5

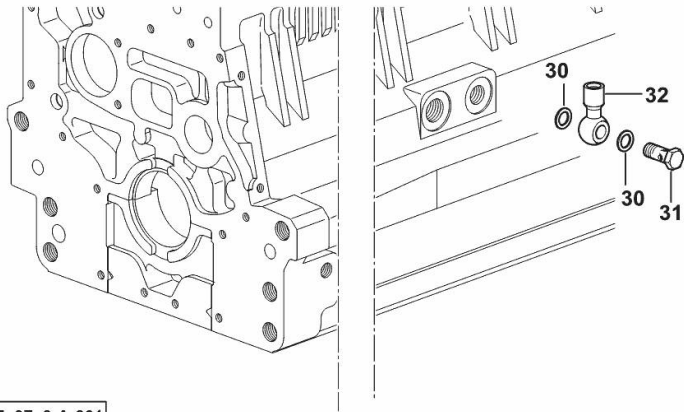

19_36215_07_0-A-001

CRANKSHAFT

Fig.	P/n	QTY	Name
------	-----	-----	------

Notes:

[AGROLUX 60 E 2WD -> D10S553WX1E5001] 5552 <- [AGROLUX 60 E 4WD -> D10S553WT1E5001] 5552 <-

7.1	0.007.1554.0/20	1	crankshaft
8	0.065.1215.0/10	4	main half bushing STANDARD
9	0.065.1216.0/10	4	main half bushing STANDARD
10	0.065.1218.0	4	shim STANDARD
15	0.065.1254.0/20	1	gasket
16	0.007.1711.0/10	1	cover
17	2.1475.002.2	9	conical washer 8
18	2.0112.207.2	9	screw m 8 p 1.25 x 20
19	2.1529.073.0	1	special oil seal 110x130x13
22	2.1599.524.7	1	washer 21x60x12
23	0.065.1323.0/30	1	gear Z = 29
24	2.1651.915.0	1	pin 12x35
25	2.3130.001.1	3	plug 1/8" gas
26	2.1720.006.0	1	key 4x6.5
801	0.065.1215.7	1	main half bushing - mm 0.25
802	0.065.1215.8	1	main half bushing - mm 0.50
901	0.065.1216.7	1	main half bushing - mm 0.25
902	0.065.1216.8	1	main half bushing - mm 0.50
1001	0.065.1218.7	1	shim + mm 0.10
1002	0.065.1218.8	1	shim + mm 0.15

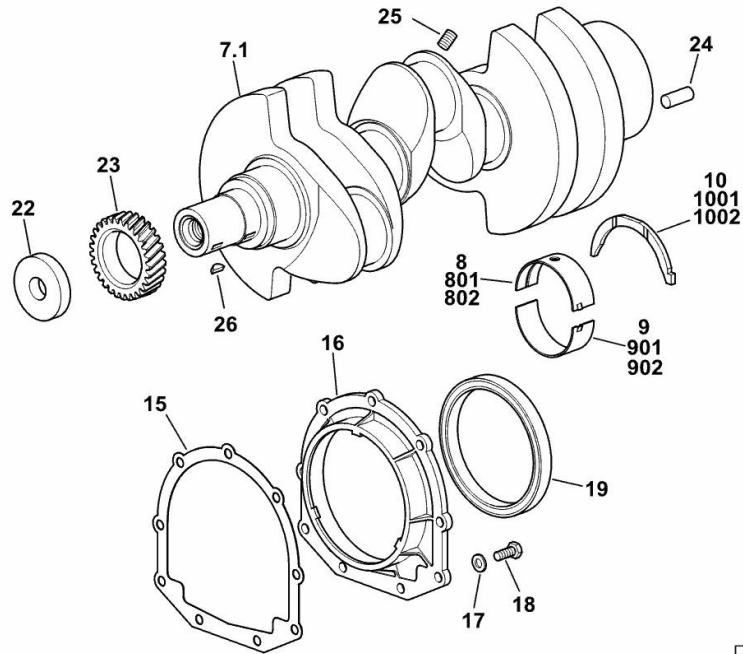

19_N8112_00_0-A-001

CRANKSHAFT

Fig.	P/n	QTY	Name
------	-----	-----	------

Notes:

[AGROLUX 60 E 2WD -> D10S553WX1E5001] [AGROLUX 60 E 4WD -> D10S553WT1E5001]

7	0.019.2255.0/20	1	crankshaft
8	0.019.5455.0	4	main half bushing STANDARD
9	0.019.5456.0	4	main half bushing STANDARD
10	0.065.1218.0	4	shim STANDARD
15	0.065.1254.0/20	1	gasket
16	0.007.1711.0/10	1	cover
17	2.1475.002.2	9	conical washer 8
18	2.0112.207.2	9	screw m 8 p 1.25 x 20
19	2.1529.073.0	1	special oil seal 110x130x13
22	2.1599.524.7	1	washer 21x60x12
23	0.065.1323.0/30	1	gear Z = 29
24	2.1651.915.0	1	pin 12x35
26	2.1720.006.0	1	key 4x6.5
1001	0.065.1218.7	1	shim + mm 0.10
1002	0.065.1218.8	1	shim + mm 0.15

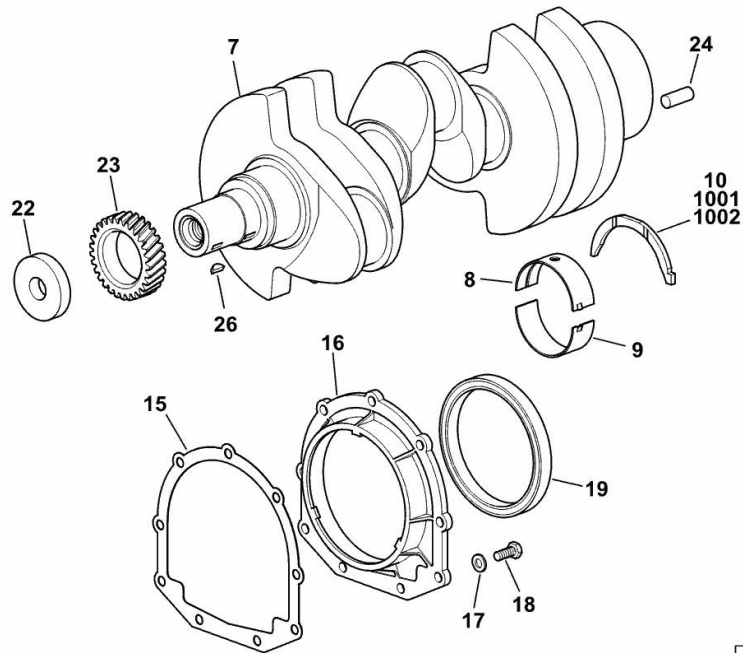

19_N8112_00_0-A-002

CRANKSHAFT PULLEY

Fig.	P/n	QTY	Name
------	-----	-----	------

Notes:

[AGROLUX 60 E 2WD -> D10S553WX1E5001] [AGROLUX 60 E 4WD -> D10S553WT1E5001]

3	0.014.5093.0	1	pulley
5	0.085.1248.0/20	1	hub
6	2.0399.144.7/10	1	screw m 20 p.1.5x51
8	2.1720.006.0	1	key 4x6.5

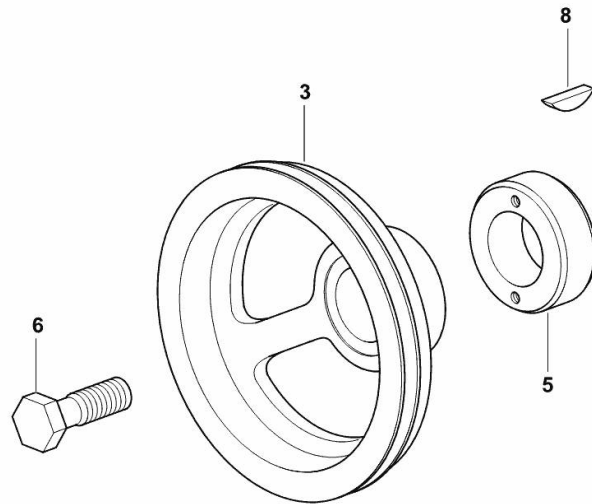

19_38512_04_0-A-001

Buy Now



Our support email:

ebooklibonline@outlook.com