

ENGINE

Fig.	P/n	QTY	Name
------	-----	-----	------

Notes:

- NOT FOR EUROPEAN MARKET [AGROTRON M 620 -> WSXL870200LD10010]

1	25009688	1	engine ON ORDERING PLEASE ENGINE NO. REQUIRED
---	----------	---	---

K9_O4919_06_0-A-001

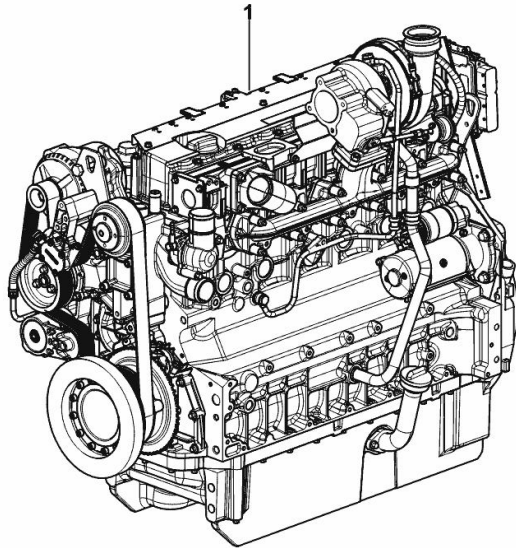

COMPRESSOR DRIVEBELT

Fig.	P/n	QTY	Name
------	-----	-----	------

Notes:

[AGROTRON M 620 -> WSXL870200LD10010]

2	04452801	1	belt AV 13x1000 mm
---	----------	---	--------------------

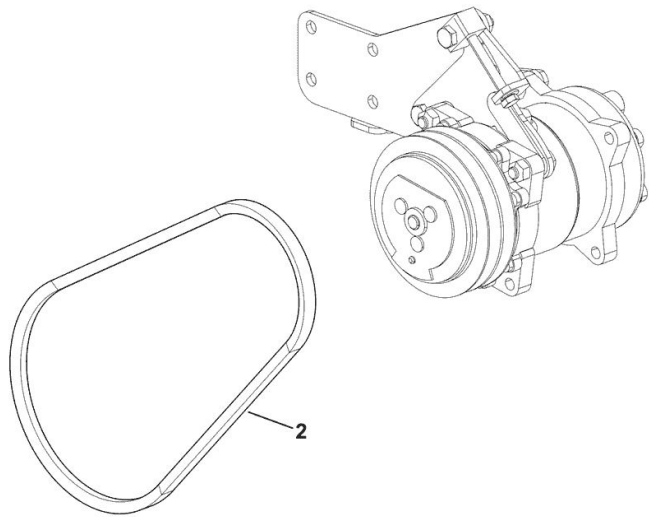

K9_L8786_22_0-B-001

COOLING SYSTEM

Fig.	P/n	QTY	Name
------	-----	-----	------

Notes:

[AGROTRON M 620 -> WSXL870200LD10010]

K9_J6383_00_0-A-004

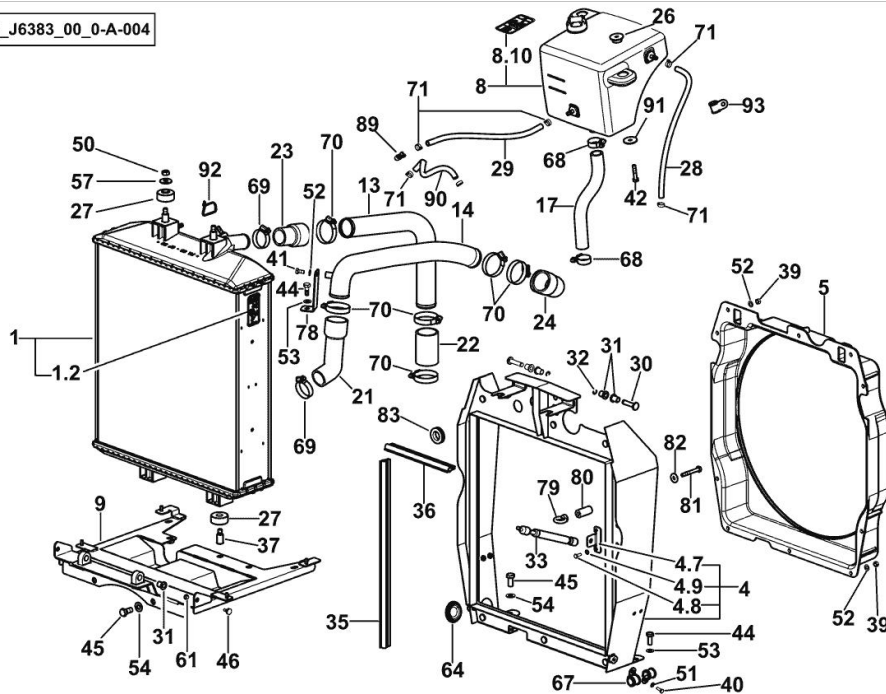

1	0.015.4317.4/20	1	water cooler
1.2	2.9939.273.0	2	plate
4	0.015.3770.4/60	1	division
4.7	0.015.6917.3	2	bracket
4.8	2.0114.005.2	4	screw m 6 p.1.0 x 16
4.9	2.1310.002.2	4	flat washer 6.4x12.5
5	0.015.7401.0/20	1	duct
8	0.015.4531.4/10	1	small tank
			☞ 0.015.4531.4/10
8.10	2.9939.280.0	1	plate
9	0.015.7486.3/40	1	plate
13	0.015.8109.0/10	1	tube
14	0.015.8117.2/20	1	pipng
17	0.015.8204.0	1	tube
21	0.015.8120.0	1	sleeve
22	0.015.8139.0	1	sleeve
23	0.015.8140.0	1	sleeve
24	0.014.9885.0	1	sleeve
26	04432147	2	ring
27	0.007.0675.0	4	silent-block
28	0.016.8501.0	1	tube Ø mm 8x14x700
29	0.016.8500.0/10	0.33	tube
30	0.014.4027.0	2	pin
31	2.1559.147.0	6	bushing
32	2.1430.009.2	2	ring 8
33	0.016.1205.4	2	shock absorber
35	0.015.8013.0/10	2	gasket
36	0.015.8022.0	2	gasket
37	04431909/10	2	pin
39	2.1011.105.2	10	nut m 8 p.1.25
40	2.0114.005.2	2	screw m 6 p.1.0 x 16
41	2.0114.205.2	1	screw m 8 p.1.25 x 16
42	2.0114.215.2	2	screw m 8 p.1.25 x 40
44	2.0114.309.2	4	screw m 10 p 1.25 x 25
45	2.0114.409.2	5	screw m 12 x 25
46	2.0119.298.2	2	pin
50	2.1011.106.2	6	nut m 10 p.1.5
51	2.1310.002.2	2	flat washer 6.4x12.5
52	2.1310.004.2	11	flat washer 8.4x17
53	2.1310.006.2	3	flat washer 10.5x21
54	2.1310.007.2	5	flat washer 13 x 24

COOLING SYSTEM

K9_J6383_00_0-A-004

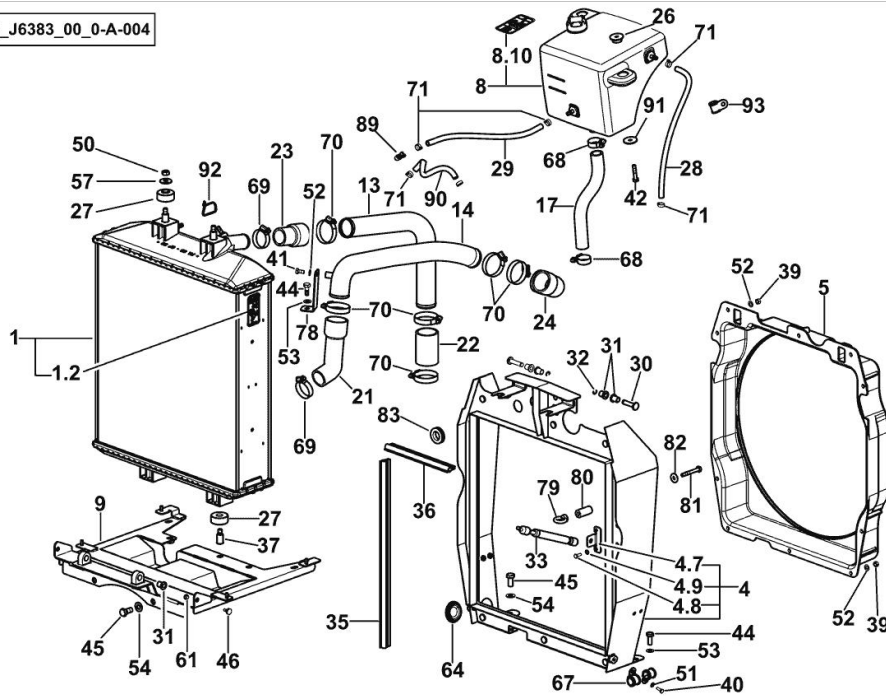

Fig.	P/n	QTY	Name
57	2.1312.005.2	2	washer 10.2
61	2.1559.487.0	2	bush 8x10x7
64	2.3199.006.0	1	plug 45
67	2.6839.058.0	4	clamp Ø 17/20
68	2.6851.003.0	2	clamp Ø 25/40
69	2.6859.156.0	2	clamp Ø 35/50
70	2.6859.158.0	6	clamp Ø 50/70
71	01173965	6	clamp 10-16/9 h3461
78	0.016.0546.0/10	1	bracket
79	0.016.3348.2	1	eyebolt m 8 p.1.25
80	2.1549.658.2	1	spacer 8.5x20x43
81	2.0112.220.2	1	screw m 8 p.1.25x55
82	2.1312.004.2	1	washer 8x24x2
83	2.6560.016.0	1	wire guide
89	2.3249.717.2	1	pipe fitting
90	0.017.6442.0/10	1	tube
91	03392102	2	washer
92	2.6852.203.0	2	clamp 292 x 4.8
93	2.6839.080.0	2	clamp Ø 15/25

BLOWER

Fig.	P/n	QTY	Name
------	-----	-----	------

Notes:

[AGROTRON M 620 -> WSXL870200LD10010]

6	04450918/10	1	fan
7	04454751/10	1	coupling
25	0.016.2331.0/10	1	flange
47	2.0312.210.2	4	screw m 8 p 1.25 x 30
49	2.0422.303.2	4	stud bolt m 10 p.1.5 x 20
50	2.1011.106.2	6	nut m 10 p.1.5
84	2.0112.205.2	6	screw m 8 p.1.25 x 16

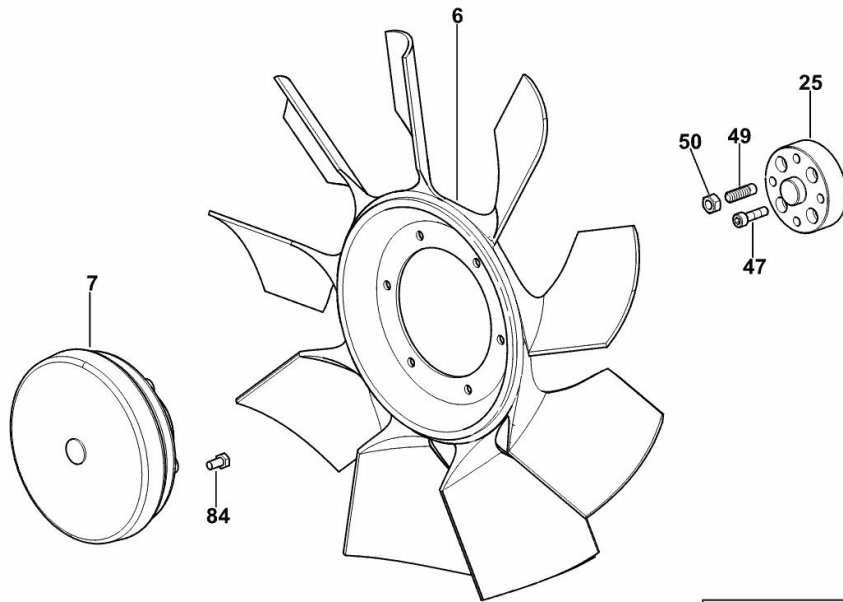

K9_J6383_00_0-C-001

COOLING SYSTEM EXPANSION TANK

Fig.	P/n	QTY	Name
1	0.015.4531.4/10	1	small tank
2	0.010.3465.1	1	plug
3	2.9939.280.0	1	plate

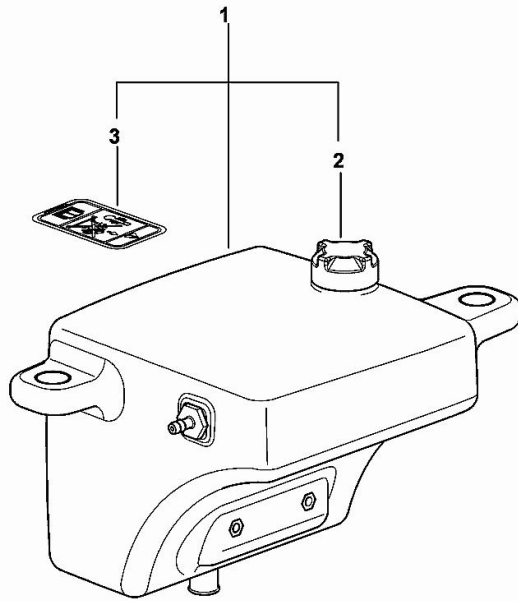

0_015_4531_4_10

INTERCOOLER

Fig.	P/n	QTY	Name
------	-----	-----	------

Notes:

[AGROTRON M 620 -> WSXL870200LD10010]

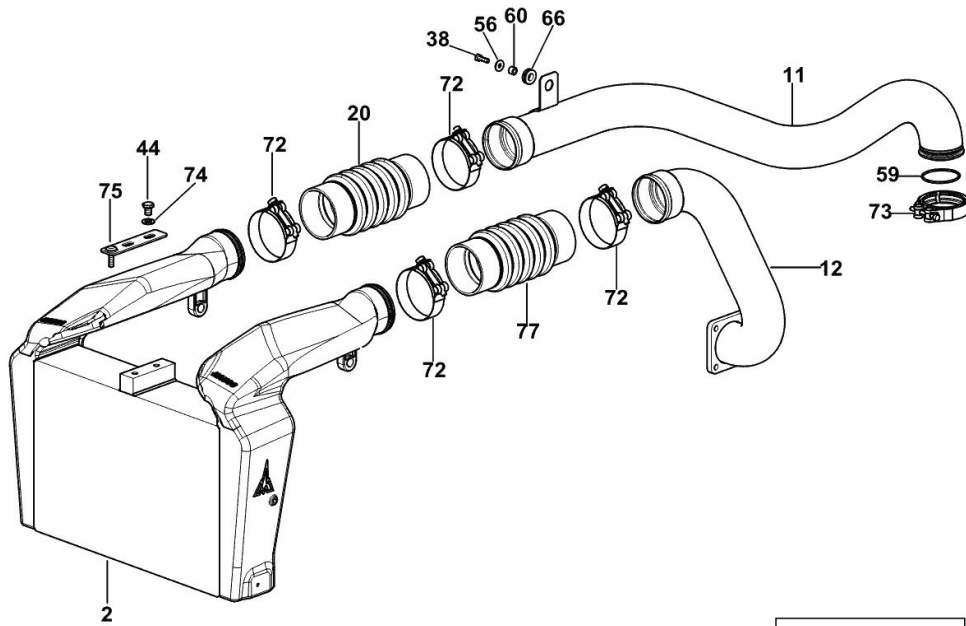

2	0.015.6910.2/20	1	intercooler
11	0.015.8053.2/40	1	pipng
12	0.015.8051.2/30	1	pipng
20	0.015.8112.0/30	1	flexible hose
38	2.0112.007.2	1	screw m 6 p.1 x 20
44	2.0114.309.2	4	screw m 10 p 1.25 x 25
56	2.1312.003.2	1	washer 6
59	2.1532.143.0	1	oil seal
60	2.1549.051.2	1	spacer 7x12x7.5
66	2.6560.006.0	1	wire guide 12x1.5
72	2.6859.110.0	4	clamp
73	2.6859.118.0	1	clamp Ø 77
74	2.1310.006.3	2	flat washer 10.5x21x2
75	0.016.1558.2	1	bracket
77	0.016.0109.0/20	1	flexible hose

K9_J6383_00_0-B-001

Buy Now



Our support email:

ebooklibonline@outlook.com