

CRANKCASE

Fig.	P/n	QTY	Name
------	-----	-----	------

Notes:

[DORADO S 90 (20'') ->7001]

3	2.3199.312.2/20	1	plug m 35x1.5x9.5
5	2.0439.273.7	8	stud bolt m 8
6	2.1559.188.2	4	bush 11.4 x 14 x16
7	2.1539.259.0	8	special oil seal 107.62x2.62
8	2.1560.010.0	1	gasket 14.2 x 20
9	2.3199.292.0	1	plug 1/4" gas
11	0.066.1152.0/10	4	gasket
13	2.1549.154.2	4	bush 4.8x5.8x16
14	0.015.2988.4/10	1	crankcase
14.1	2.3130.001.1	10	plug 1/8" gas
14.2	2.3130.002.1	2	plug 1/4" gas
14.3	2.3130.003.1	6	plug 3/8" gas
14.4.1.1.1	0.065.1112.7/10	1	support
14.4.1.2	2.1699.165.0	1	bush 12.3x15x16
14.4.2	0.065.1114.0/10	3	support
14.4.3	0.065.1116.3	1	support
14.4.3.2	2.1699.165.0	1	bush 12.3x15x16
14.4.5	0.065.1117.0	10	screw m 12 x 100
14.5	2.3179.012.0	1	plug 60
14.6	0.065.1140.0	4	special bushing 59X55X20
14.7	0.065.1141.0	1	special bushing 59X55X30
14.8	0.014.1340.0/10	1	pin mm 85
25	0.013.4946.0/10	1	sprayer nozzle
26	2.3120.101.0	1	plug m 18 p.1.5
28	2.1560.014.0	1	washer 18.2 x 24

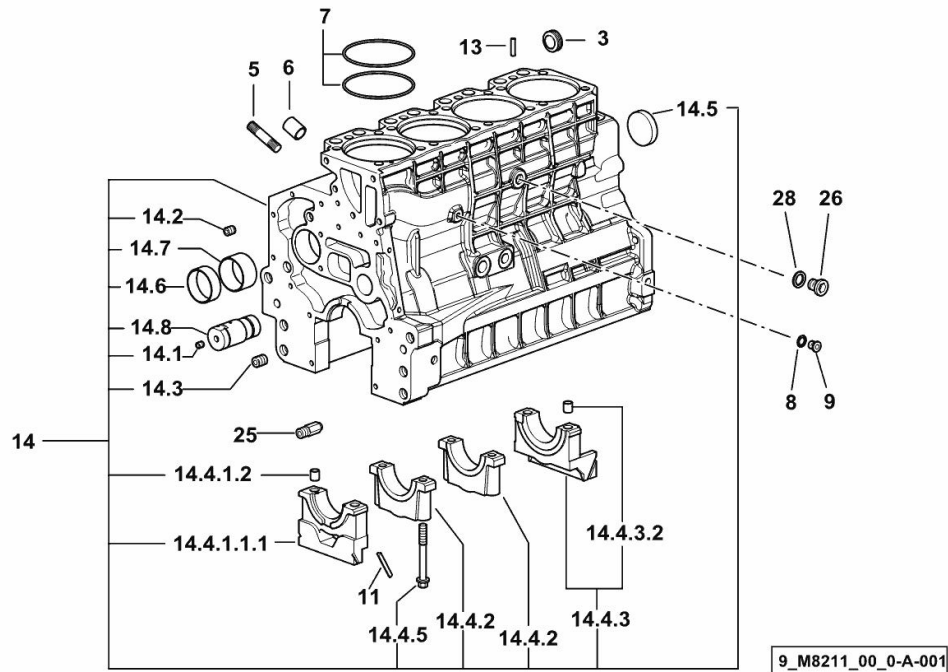

CRANKCASE

Fig.	P/n	QTY	Name
------	-----	-----	------

Notes:

- EXPORT U.S.A. [DORADO S 90 (20'') ->7001]

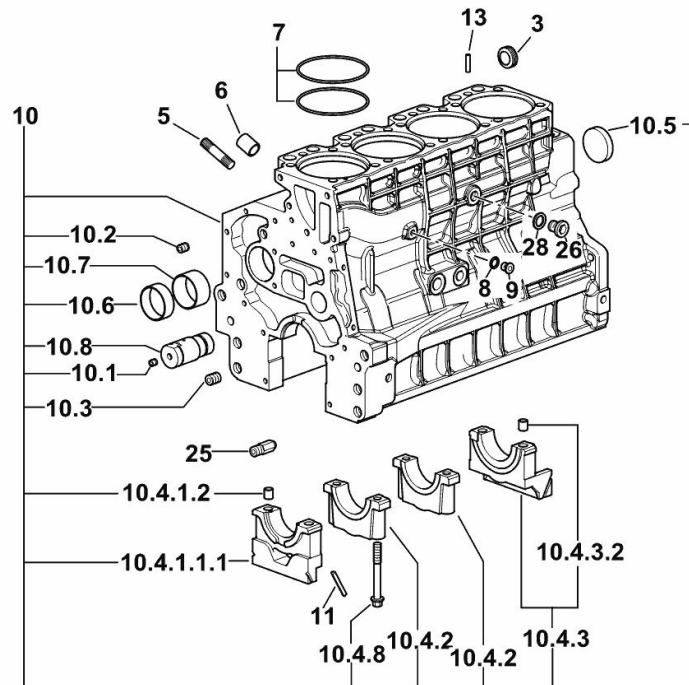

9_O1011_00_0-A-001

3	2.3199.312.2/20	1	plug m 35x1.5x9.5
5	2.0439.279.7	8	stud bolt m 8 p.1 x 25
6	2.1559.188.2	4	bush 11.4 x 14 x16
7	2.1539.259.0	8	special oil seal 107.62x2.62
8	2.1560.010.0	1	gasket 14.2 x 20
9	2.3199.292.0	1	plug 1/4" gas
10	0.014.9655.4/30	1	crankcase
10.1	2.3130.001.1	14	plug 1/8" gas
10.2	2.3130.002.1	4	plug 1/4" gas
10.3	2.3130.003.1	6	plug 3/8" gas
10.4.1.1.1	0.065.1112.7/10	1	support
10.4.1.2	2.1699.165.0	1	bush 12.3x15x16
10.4.2	0.065.1114.0/10	3	support
10.4.3	0.065.1116.3	1	support
10.4.3.2	2.1699.165.0	1	bush 12.3x15x16
10.4.8	0.065.1117.0	10	screw m 12 x 100
10.5	2.3179.012.0	1	plug 60
10.6	0.065.1140.0	4	special bushing 59X55X20
10.7	0.065.1141.0	1	special bushing 59X55X30
10.8	0.014.1340.0/10	1	pin mm 85
11	0.066.1152.0/10	4	gasket
13	2.1549.154.2	4	bush 4.8x5.8x16
25	0.013.4946.0/10	1	sprayer nozzle
26	2.3120.101.0	1	plug m 18 p.1.5
28	2.1560.014.0	1	washer 18.2 x 24

MONOBLOC ENGINE-GEARBOX CONNECTING FLANGE

Fig.	P/n	QTY	Name
------	-----	-----	------

Notes:

[DORADO S 90 (20'') ->7001]

1	0.007.1882.0/50	1	flange
2	2.0112.511.2	8	screw m 14 p.2 x 30
3	2.1651.912.0	2	cylindrical plug 12x28
4	2.1651.917.0	1	cylindrical plug 12x40
5	2.0432.257.7	1	stud bolt m 12 p.1.75 - 1.25 x 30
6	2.0439.250.7	1	stud bolt m 12 / m 10 x 30
7	0.011.9294.0/10	1	bush

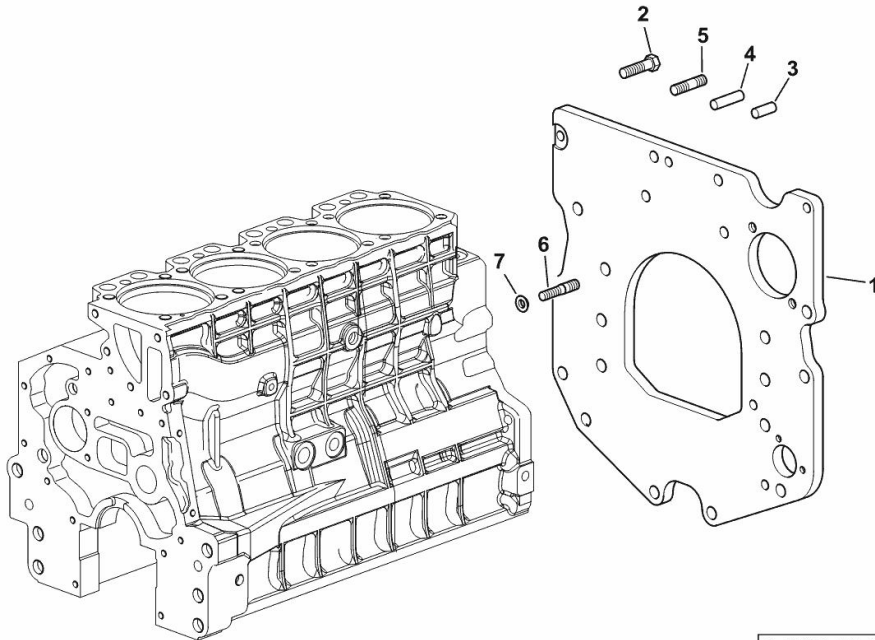

9_38611_01_0-A-001

ENGINE OIL AND TURBO PRESSURE SWITCH UNION

Fig.	P/n	QTY	Name
------	-----	-----	------

Notes:

[DORADO S 90 (20'') ->7001]

10	2.3339.787.0/10	1	pipe fitting 7/16"
11	2.3110.403.1	1	plug m 14 p.1.5x12
12	2.1560.010.0	2	gasket 14.2 x 20
13	2.1019.129.2/10	1	nut m 18 p.1.5x12
14	2.1533.038.0	1	oil seal 15.45x2.62

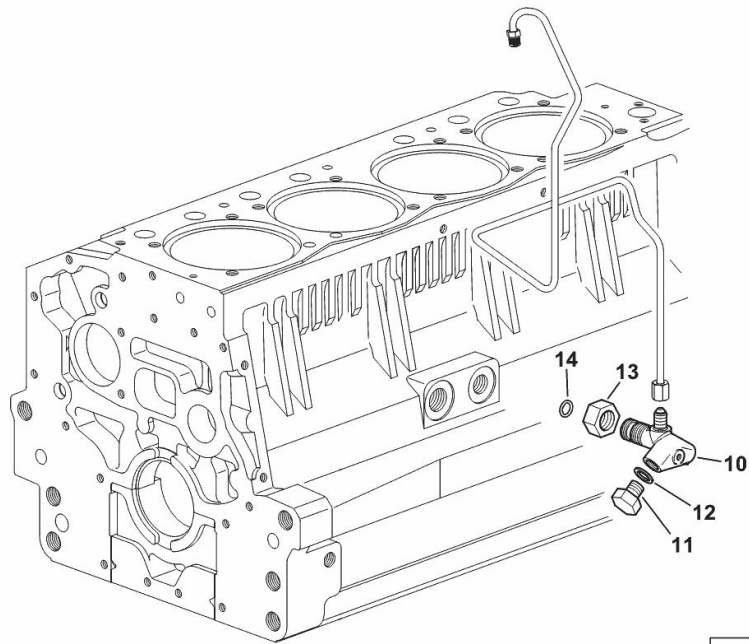

9_36615_01_0-B-001

PLUG

Fig.	P/n	QTY	Name
------	-----	-----	------

Notes:

[DORADO S 90 (20'') ->7001]

1	2.3130.003.1	1	plug 3/8" gas
---	--------------	---	---------------

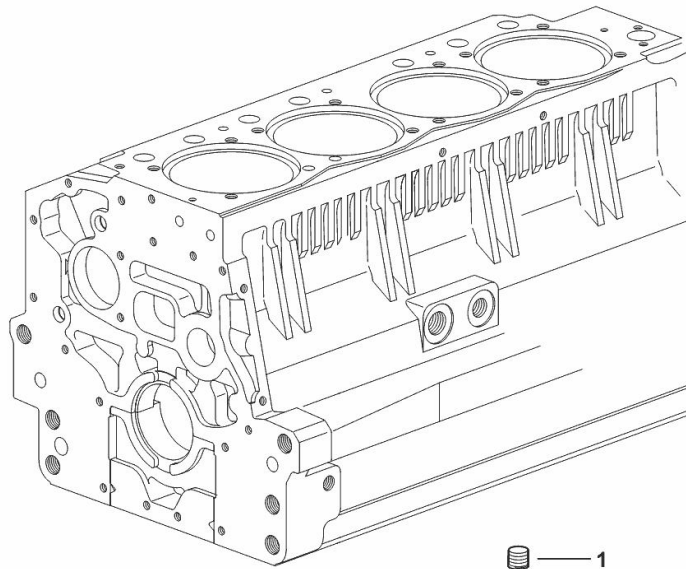

9_34311_06_0-A-001

CRANKSHAFT

Fig.	P/n	QTY	Name
------	-----	-----	------

Notes:

[DORADO S 90 (20'') ->7001]

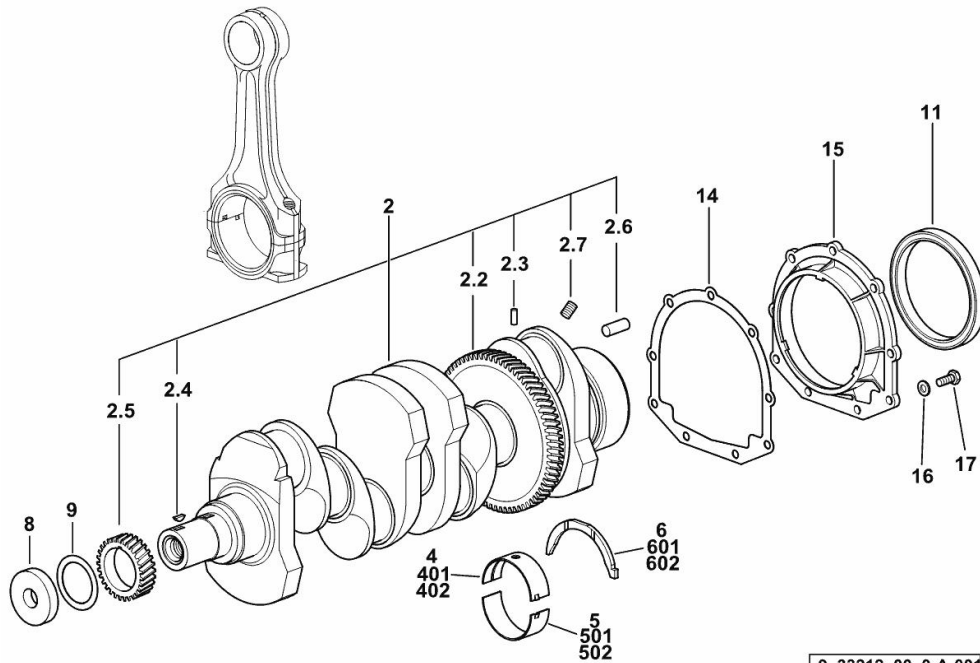

9_33212_00_0-A-001

2	0.086.1210.3/40	1	crankshaft
2.2	0.065.1211.0/10	1	crown wheel
2.3	2.1630.608.0	1	pin 6x16
2.4	2.1720.006.0	1	key 4x6.5
2.5	0.065.1323.0/30	1	gear Z = 29
2.6	2.1651.915.0	1	pin 12x35
2.7	2.3130.001.1	4	plug 1/8" gas
4	0.065.1215.0/10	5	main half bushing STANDARD
5	0.065.1216.0/10	5	main half bushing STANDARD
6	0.065.1218.0	4	shim STANDARD
8	2.1599.524.7	1	washer 21x60x12
9	2.1589.189.0	2	shoulder ring mm 1.00
11	2.1529.073.0	1	special oil seal 110x130x13
14	0.065.1254.0/20	1	gasket
15	0.007.1711.0/10	1	cover
16	2.1475.002.2	9	conical washer 8
17	2.0112.207.2	9	screw m 8 p 1.25 x 20
401	0.065.1215.7		main half bushing - mm 0.25
402	0.065.1215.8		main half bushing - mm 0.50
501	0.065.1216.7		main half bushing - mm 0.25
502	0.065.1216.8		main half bushing - mm 0.50
601	0.065.1218.7		shim + mm 0.10
602	0.065.1218.8		shim + mm 0.15

CRANKSHAFT PULLEY

Fig.	P/n	QTY	Name
------	-----	-----	------

Notes:

[DORADO S 90 (20'') ->7001]

1	0.013.6349.0/10	1	pulley
2	0.011.3515.0/20	1	hub Z = 48
3	0.065.1256.0	2	ring 45x52
4	2.1579.865.0	1	spacer 45.2x51.8x10
5	2.0439.195.7	1	stud bolt m 20 p.1.5x80
6	2.1019.094.7	1	nut m 20 p.1.5
7	2.0112.320.2	6	screw m 10 p.1.5 x 55
8	2.1470.006.2	6	lock washer 10

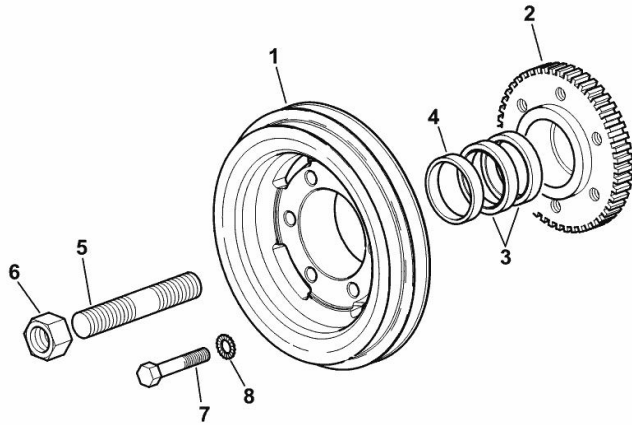

9_N1412_03_0-A-001

Buy Now



Our support email:

ebooklibonline@outlook.com