

ENGINE TYPE-APPROVAL DATA PLATE

Fig.	P/n	QTY	Name
------	-----	-----	------

Notes:

[EXPLORER³ 90 T CLASSIC 2WD -> 10001] [EXPLORER³ 90 T CLASSIC 4WD -> 10001]

1	0.000.0000.1		cannot be supplied MADE BY TREVIGLIO ITALY
2	0.000.0000.1		cannot be supplied MADE AT RANIPET - INDIA

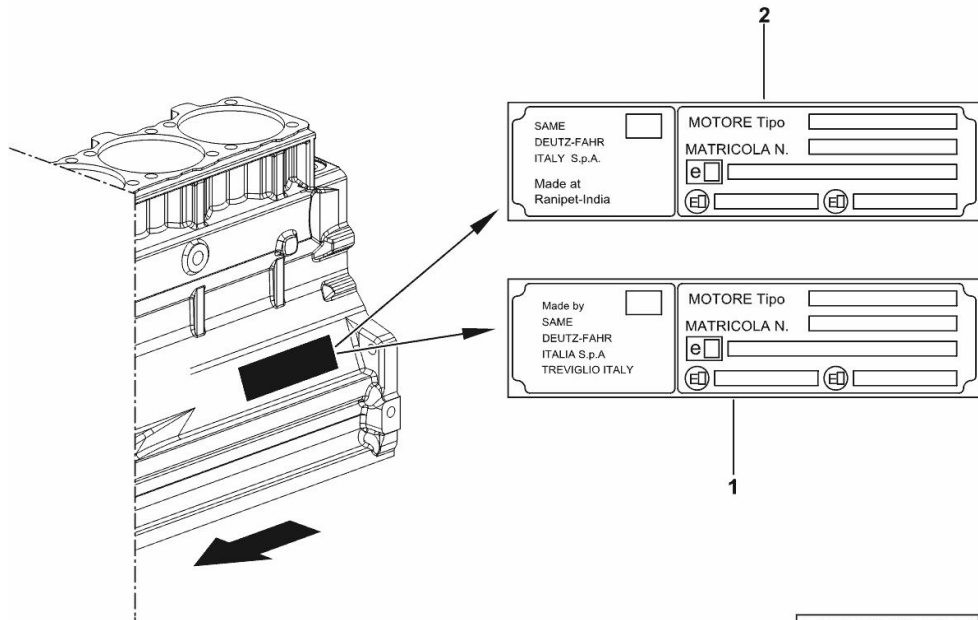

9_STA000_00_0-A-001

CRANKCASE

Fig.	P/n	QTY	Name
------	-----	-----	------

Notes:

FOR ENGINES PRODUCED IN : TREVIGLIO ITALY [EXPLORER³ 90 T CLASSIC 2WD -> 10001] FOR ENGINES PRODUCED IN : TREVIGLIO ITALY [EXPLORER³ 90 T CLASSIC 4WD -> 10001]

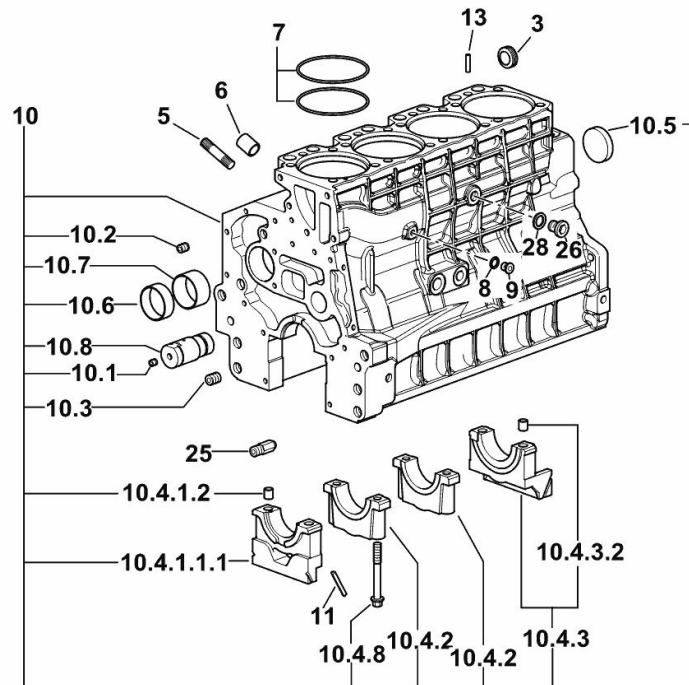

9_O1011_00_0-A-001

3	2.3199.312.2/20	1	plug m 35x1.5x9.5
5	2.0439.279.7	8	stud bolt m 8 p.1 x 25
6	2.1559.188.2	4	bush 11.4 x 14 x16
7	2.1539.259.0	8	special oil seal 107.62x2.62
8	2.1560.010.0	1	gasket 14.2 x 20
9	2.3199.292.0	1	plug 1/4" gas
10	0.014.9655.4/30	1	crankcase
10.1	2.3130.001.1	14	plug 1/8" gas
10.2	2.3130.002.1	4	plug 1/4" gas
10.3	2.3130.003.1	6	plug 3/8" gas
10.4.1.1.1	0.065.1112.7/10	1	support
10.4.1.2	2.1699.165.0	1	bush 12.3x15x16
10.4.2	0.065.1114.0/10	3	support
10.4.3	0.065.1116.3	1	support
10.4.3.2	2.1699.165.0	1	bush 12.3x15x16
10.4.8	0.065.1117.0	10	screw m 12 x 100
10.5	2.3179.012.0	1	plug 60
10.6	0.065.1140.0	4	special bushing 59X55X20
10.7	0.065.1141.0	1	special bushing 59X55X30
10.8	0.014.1340.0/10	1	pin mm 85
11	0.066.1152.0/10	4	gasket
13	2.1549.154.2	4	bush 4.8x5.8x16
25	0.013.4946.0/10	1	sprayer nozzle
26	2.3120.101.0	1	plug m 18 p.1.5
28	2.1560.014.0	1	washer 18.2 x 24

CRANKCASE

Fig.	P/n	QTY	Name
------	-----	-----	------

Notes:

FOR ENGINES PRODUCED IN : RANIPET - INDIA [EXPLORER³ 90 T CLASSIC 2WD -> 10001] FOR ENGINES PRODUCED IN : RANIPET - INDIA [EXPLORER³ 90 T CLASSIC 4WD -> 10001]

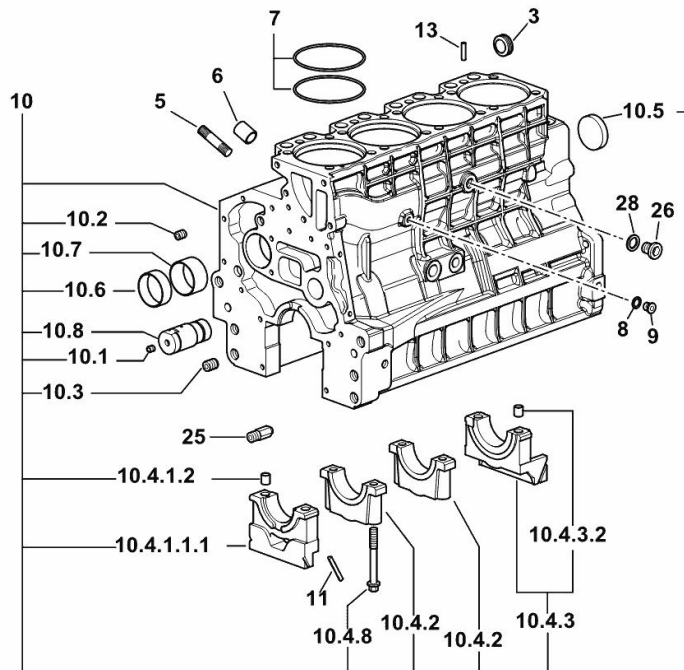

19_O1011_00_0-A-001

3	2.3199.312.2/20	1	plug m 35x1.5x9.5
5	2.0439.279.7	8	stud bolt m 8 p.1 x 25
6	2.1559.188.2	4	bush 11.4 x 14 x16
7	2.1539.259.0	8	special oil seal 107.62x2.62
8	2.1560.010.0	1	gasket 14.2 x 20
9	2.3199.292.0	1	plug 1/4" gas
10	0.014.9655.4/30	1	crankcase
10.1	2.3130.001.1	14	plug 1/8" gas
10.2	2.3130.002.1	4	plug 1/4" gas
10.3	2.3130.003.1	6	plug 3/8" gas
10.4.1.1.1	0.065.1112.7/10	1	support
10.4.1.2	2.1699.165.0	1	bush 12.3x15x16
10.4.2	0.065.1114.0/10	3	support
10.4.3	0.065.1116.3	1	support
10.4.3.2	2.1699.165.0	1	bush 12.3x15x16
10.4.8	0.065.1117.0	10	screw m 12 x 100
10.5	2.3179.012.0	1	plug 60
10.6	0.065.1140.0	4	special bushing 59X55X20
10.7	0.065.1141.0	1	special bushing 59X55X30
10.8	0.014.1340.0/10	1	pin mm 85
11	0.066.1152.0/10	4	gasket
13	2.1549.154.2	4	bush 4.8x5.8x16
25	0.013.4946.0/10	1	sprayer nozzle
26	2.3120.101.0	1	plug m 18 p.1.5
28	2.1560.014.0	1	washer 18.2 x 24

LOWER PLUG FOR CYLINDER BLOCKS

Fig.	P/n	QTY	Name
------	-----	-----	------

Notes:

FOR ENGINES PRODUCED IN : TREVIGLIO ITALY [EXPLORER³ 90 T CLASSIC 2WD -> 10001] FOR
 ENGINES PRODUCED IN : TREVIGLIO ITALY [EXPLORER³ 90 T CLASSIC 4WD -> 10001]

1	2.3130.003.1	2	plug 3/8" gas
---	--------------	---	---------------

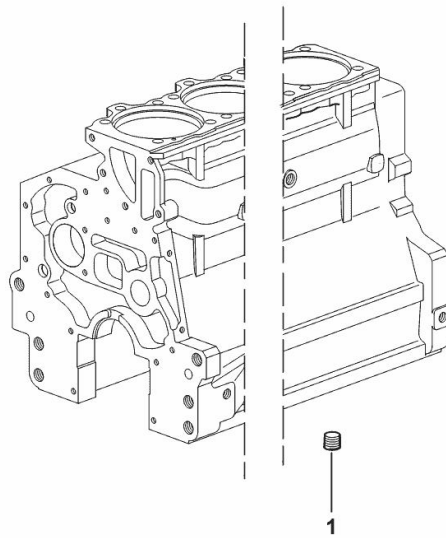

9_33311_06_0-A-001

LOWER PLUG FOR CYLINDER BLOCKS

Fig.	P/n	QTY	Name
------	-----	-----	------

Notes:

FOR ENGINES PRODUCED IN : RANIPET - INDIA [EXPLORER³ 90 T CLASSIC 2WD -> 10001] FOR ENGINES PRODUCED IN : RANIPET - INDIA [EXPLORER³ 90 T CLASSIC 4WD -> 10001]

1	2.3130.003.1	2	plug 3/8" gas
---	--------------	---	---------------

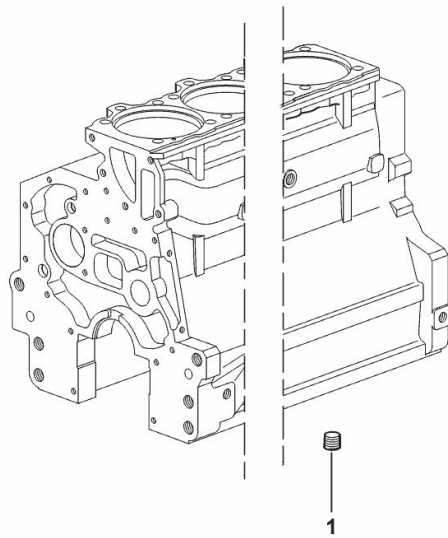

19_37511_06_0-A-001

SIDE PLUG FOR CYLINDER BLOCK

Fig.	P/n	QTY	Name
------	-----	-----	------

Notes:

FOR ENGINES PRODUCED IN : TREVIGLIO ITALY [EXPLORER³ 90 T CLASSIC 2WD -> 10001] FOR
ENGINES PRODUCED IN : TREVIGLIO ITALY [EXPLORER³ 90 T CLASSIC 4WD -> 10001]

22	2.1560.017.0	1	gasket 22.2 x 27
23	2.3120.002.4	1	plug m 22 x 1.5

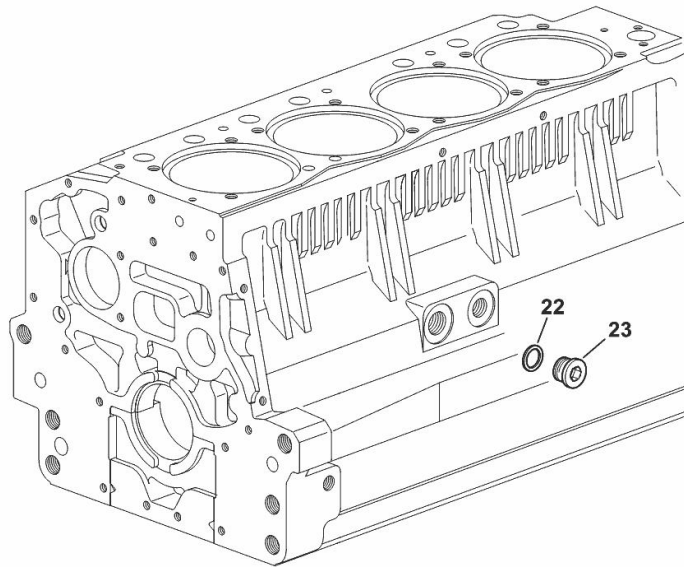

9_33211_07_0-A-001

SIDE PLUG FOR CYLINDER BLOCK

Fig.	P/n	QTY	Name
------	-----	-----	------

Notes:

FOR ENGINES PRODUCED IN : RANIPET - INDIA [EXPLORER³ 90 T CLASSIC 2WD -> 10001] FOR ENGINES
PRODUCED IN : RANIPET - INDIA [EXPLORER³ 90 T CLASSIC 4WD -> 10001]

22	2.1560.017.0	1	gasket 22.2 x 27
23	2.3120.002.4	1	plug m 22 x 1.5

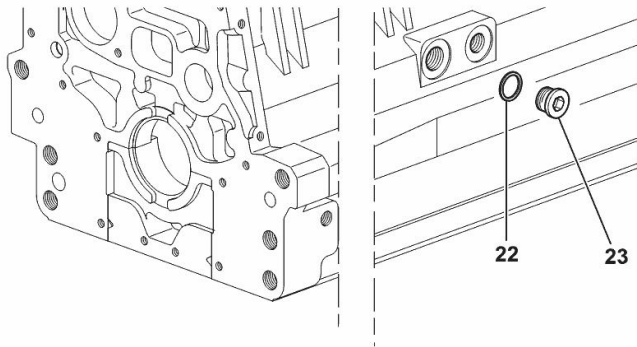

I9_33211_07_0-A-001

Buy Now



Our support email:

ebooklibonline@outlook.com