

PTO INPUT SHAFT

Fig.	P/n	QTY	Name
------	-----	-----	------

Notes:
 [NITRO R 110 T4i -> ZKDY420200TL10001]

4	0.008.8341.0/10	1	flex coupling
7	0.009.1758.0/40	1	flange
8	0.018.6495.0	1	power take-off shaft
11	0.019.2206.0	1	flange
20	2.0312.317.2	6	screw m 10 x 55
21	2.0112.319.2	6	screw m 10 p.1.5 x 50
28	2.1120.006.2	3	nut m 10 p.1.5
29	2.1310.006.2	3	flat washer 10.5x21
34	2.1470.006.2	16	lock washer 10
37	2.1480.015.2	6	washer 10
49	2.1630.615.0	1	roll pin 6x40
61	0.019.2387.0	1	spacer

9_Y5259_85_0-A-001

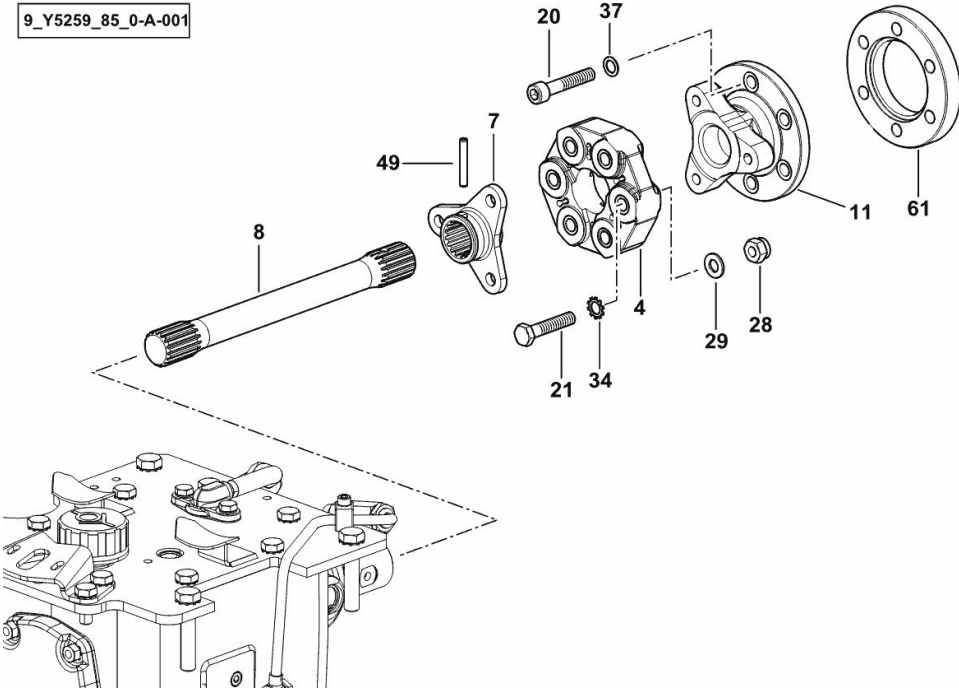

FRONT PTO CASING

Fig.	P/n	QTY	Name
------	-----	-----	------

Notes:

[NITRO R 110 T4i -> ZKDY420200TL10001]

1	0.007.5325.0/10	1	cover
12	0.017.5992.0/10	1	box
14	0.019.0312.3/10	1	cover
19	2.0112.309.2	10	screw m 10 p.1.5 x 25
22	2.0112.421.2	4	screw m 12 p.1.75 x 60
26	2.0432.001.7	6	stud bolt m 8 p.1.25 - 1.00 x 16
27	2.1011.405.2	6	nut m 8 p.1
33	2.1470.004.2	6	lock washer 8
34	2.1470.006.2	16	lock washer 10
35	2.1470.007.2	4	lock washer 12
47	2.1560.017.0	2	gasket 22.2 x 27
53	2.3120.002.4	2	plug m 22 x 1.5
54	2.3199.344.0	1	plug
58	2.1560.023.0	1	copper gasket 30.3 x 36
59	2.3110.425.2	1	plug m 30
60	0.019.1504.0	1	support

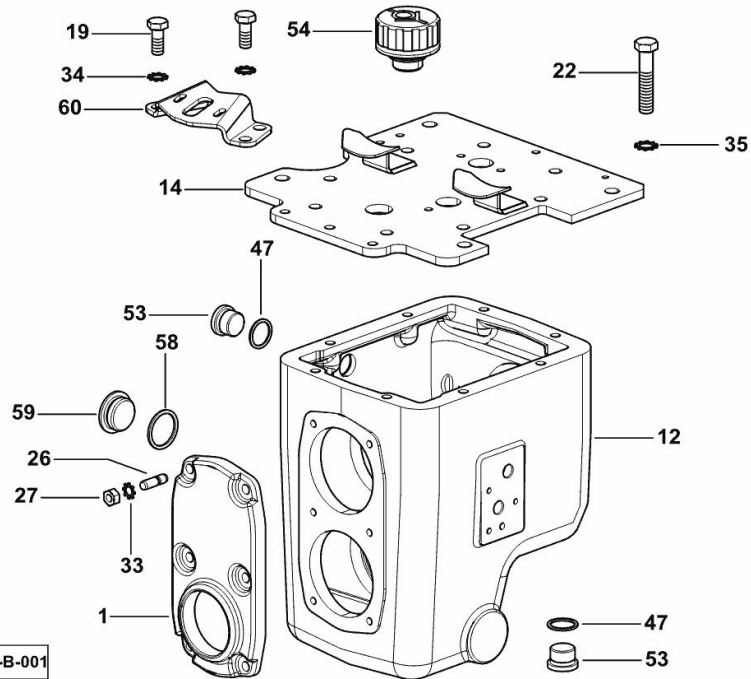

9_Y5259_85_0-B-001

FRONT PTO PACKAGE

Fig.	P/n	QTY	Name
------	-----	-----	------

Notes:
 [NITRO R 110 T4i -> ZKDY420200TL10001]

3	0.154.3655.0/10	1	guard
6	2.0112.421.2	4	screw m 12 p.1.75 x 60
7	2.1470.007.2	4	lock washer 12

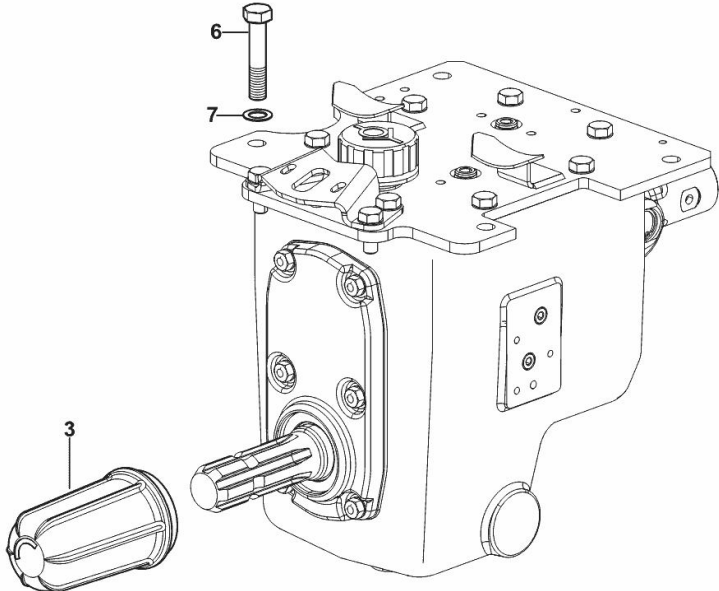

9_Y7259_86_0-A-001

P.T.O. FRONT

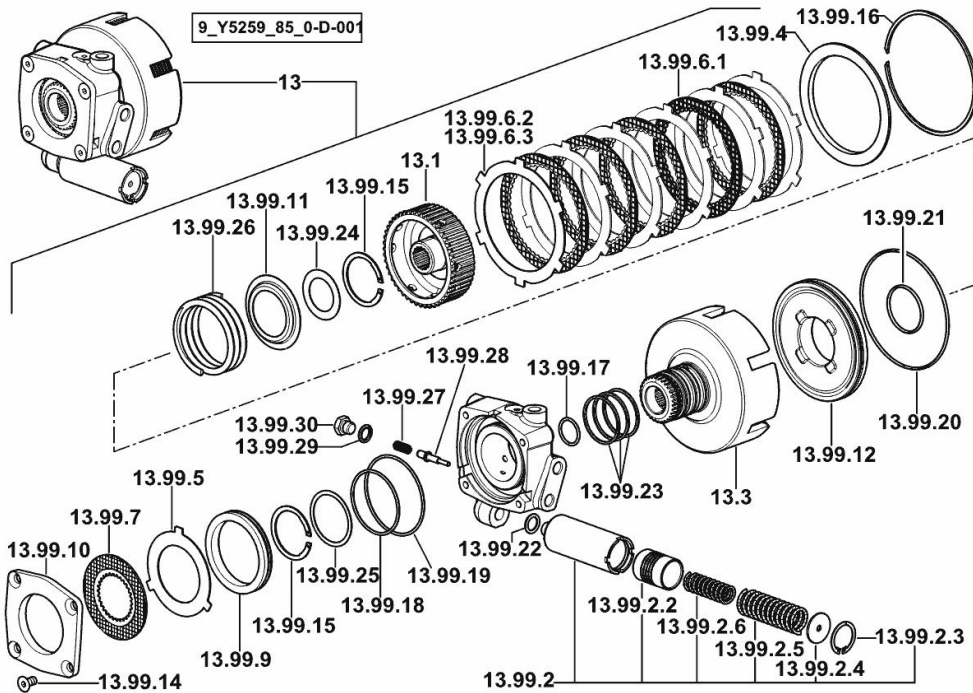

Notes:

[NITRO R 110 T4i -> ZKDY420200TL10001]

Fig.	P/n	QTY	Name
13	0.018.9244.4	1	hydraulic PTO clutch
13.1	0.008.8806.0/20	1	hub
13.3	0.011.9892.0/10	1	body
13.99.2	0.010.0526.4/10	1	accumulator P.T.O.
13.99.2.2	0.010.0525.0	1	piston
13.99.2.3	2.1411.013.7	1	circlip Ø 32
13.99.2.4	2.1599.241.0	1	shoulder ring
13.99.2.5	2.4019.636.1	1	spring 20.8 x 27.2 x 3.2 x 86.5
13.99.2.6	2.4019.638.1	1	spring 14.2 x 19.4 x 2.6 x 58
13.99.4	0.011.9895.0	1	disc
13.99.5	0.013.8983.0	1	disc mm 1.5
13.99.6.1	0.016.9060.2	5	clutch plate
13.99.6.2	0.017.9828.0	3	disc mm 1.55
13.99.6.3	0.013.9453.0	3	disc mm 1.75
13.99.7	0.014.0360.2	1	brake disc
13.99.9	0.255.3922.0/40	1	piston D 84
13.99.10	0.255.3926.0/10	1	cover
13.99.11	0.255.3933.0	1	disc
13.99.12	0.255.3938.0/40	1	piston
13.99.14	2.0342.303.6	4	screw m 8 p. 1.25x16
13.99.15	2.1419.027.1	2	circlip 48
13.99.16	2.1423.127.7	1	circlip 127
13.99.17	2.1530.062.0	1	oil seal 23.81 x 2.62
13.99.18	2.1532.150.0	1	oil seal 61.60x2.62
13.99.19	2.1532.505.0	1	oil seal 77.50 x 2.62
13.99.20	2.1539.064.0	1	special oil seal 120.33x2.62
13.99.21	2.1539.067.0	1	special oil seal 44.12x2.72
13.99.22	2.1560.010.0	1	gasket 14.2 x 20
13.99.23	2.1569.109.0/10	3	gasket 46 x 50 x 2.0
13.99.24	2.1599.415.0	1	shoulder ring 35x52x1
13.99.25	2.1599.416.0	1	shoulder ring 50x58x1
13.99.26	2.4019.373.1	1	spring 79.5x61.5x6.5
13.99.27	0.017.6983.0	1	slider
13.99.28	2.4019.496.1/10	1	spring 7.6X9.2X0.8X39
13.99.29	2.1561.006.0	1	oil seal 12
13.99.30	2.3110.422.2	1	plug m 12 p.1.25

P.T.O. FRONT

Fig.	P/n	QTY	Name
------	-----	-----	------

Notes:

[NITRO R 110 T4i -> ZKDY420200TL10001]

9_Y5259_85_0-E-001

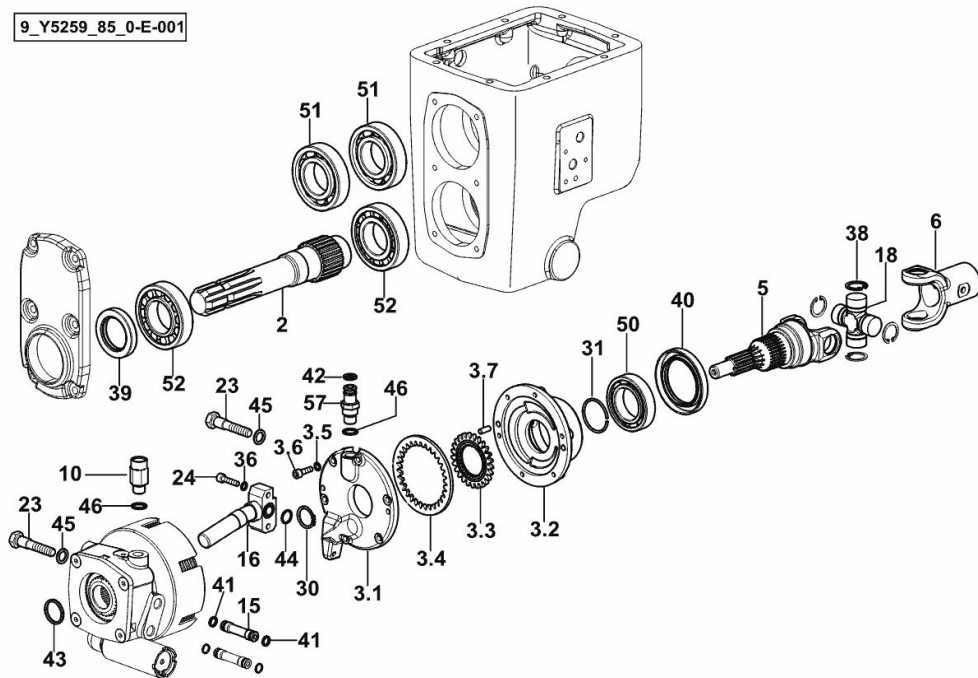

2	0.007.5328.0/20	1	power take-off shaft
3.1	0.008.2669.0/20	1	cover
3.2	0.008.1361.0/10	1	pump casing
3.3	0.008.1363.0/10	1	pinion z = 25 z = 30
3.4	0.008.1362.0/10	1	crown wheel Z = 31
3.5	2.1480.012.2	6	washer 6, d128
3.6	2.0312.106.2	6	screw m 6 p.1 x 20
3.7	2.1651.507.0	2	pin 6 x 16
5	0.008.8346.0/30	1	shaft
6	0.009.1757.0/10	1	sleeve
10	2.3249.747.0	1	pipe fitting
15	0.017.6860.0	2	tube
16	0.017.6867.3	1	tube
18	0.146.4632.4/10	1	universal joint
23	2.0119.154.2	2	screw m 12 p.1.75x58
24	2.0312.108.2	2	screw m 6 p.1 x 25
30	2.1410.009.1	1	circlip 24
31	2.1420.016.0	1	circlip a 40
36	2.1480.012.2	2	washer 6, d128
38	2.1499.012.1/10	4	circlip Ø 24
39	2.1520.220.0	1	oil seal 40x60x10
40	2.1520.229.0	1	oil seal
41	2.1530.019.0	4	oil seal 9.25x1.78
42	2.1530.024.0	1	oil seal 10.78 x 2.62
43	2.1530.062.0	1	oil seal 23.81 x 2.62
44	2.1532.035.0	1	oil seal 14x1.78
45	2.1560.008.0	2	gasket 12.2 x 18
46	2.1560.009.0	2	gasket 14.2x18
50	2.2030.009.0	1	ball bearing iso 40 bc 10
51	2.2040.012.0	2	ball bearing iso 40 bc 02
52	2.2423.012.0	2	roller bearing 40 x 80 x 18
57	2.3339.537.2	1	pipe fitting m 14 p.1.5

P.T.O. FRONT

Fig.	P/n	QTY	Name
------	-----	-----	------

Notes:
[NITRO R 110 T4i -> ZKDY420200TL10001]

1	0.018.0002.3	1	shaft Z = 20
1.2	2.1559.023.0/10	1	special bushing 15.8x19x20
2	0.018.0001.0	1	gear Z = 39

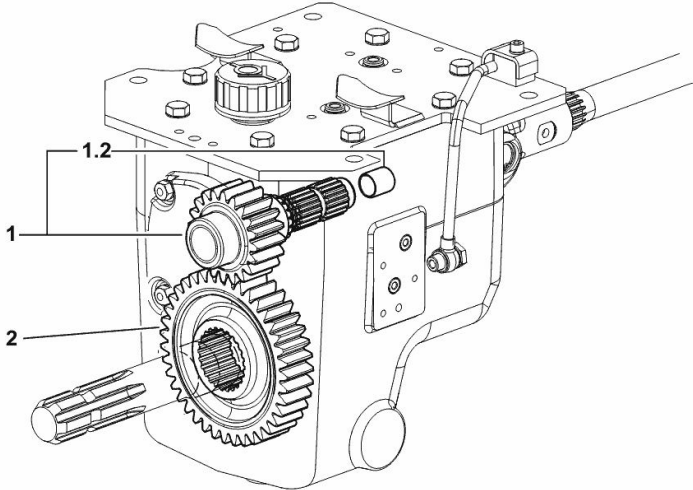

9_R8959_85_0-A-001

FRONT PTO HYDRAULIC SYSTEM

Fig.	P/n	QTY	Name
------	-----	-----	------

Notes:

[NITRO R 110 T4i -> ZKDY420200TL10001]

17	0.019.9674.3	1	tube
25	2.0312.110.2	1	screw
32	2.1470.002.2	1	lock washer 6
48	2.1561.106.0	2	gasket Ø 12 -B-
55	01141549	1	terminal d=8
56	2.3339.765.2/10	1	pipe union m 12 p.1x23
65	0.019.9675.3	1	screw
66	2.0112.207.2	2	screw m 8 p 1.25 x 20
67	2.1561.003.0	2	washer
68	0.019.9677.3	1	tube
69	0.052.1558.0/10	1	gasket

9_Y5259_85_0-C-001

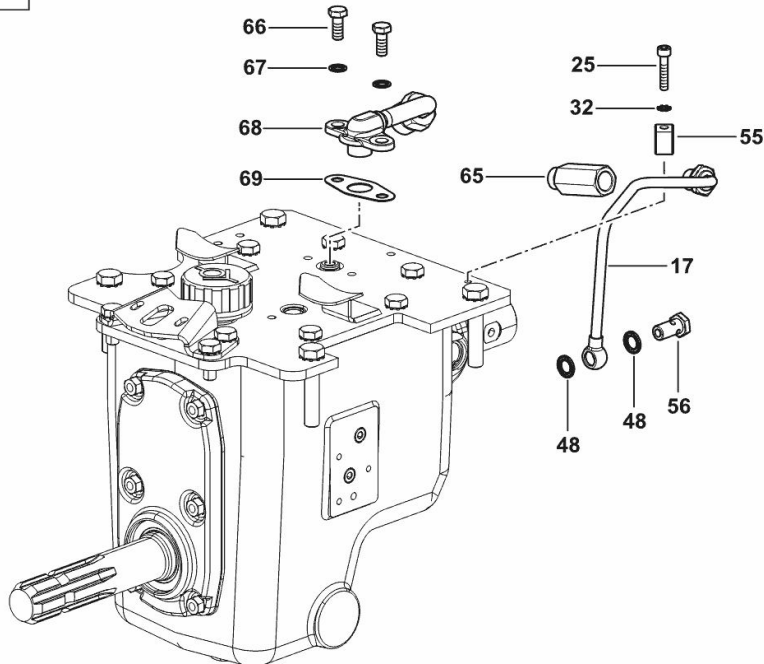

Buy Now



Our support email:

ebooklibonline@outlook.com