

Section: ENGINE
CYLINDER HEAD

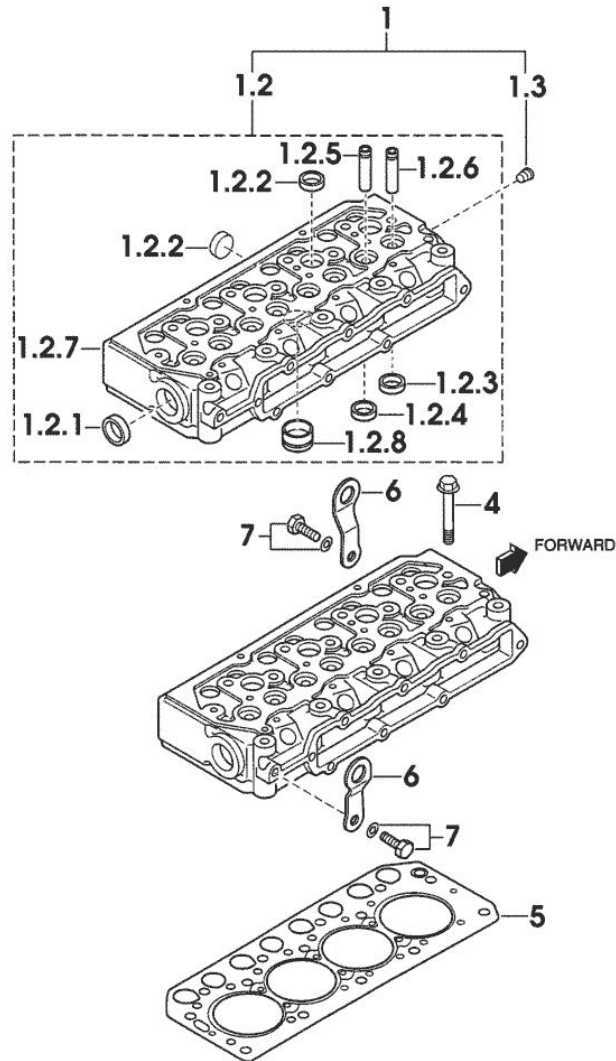

Fig.	P/n	QTY	Name
------	-----	-----	------

Notes:
 [R1.50]

1	0.010.3986.1	1	engine head
1.2	0.000.0000.1		cannot be supplied
1.2.1	0.010.2634.1	1	plug
1.2.2	0.009.4527.0	7	plug
1.2.3	0.000.0000.1		cannot be supplied
1.2.4	0.000.0000.1		cannot be supplied
1.2.5	0.010.2634.2	4	valve guide
1.2.6	0.010.2635.0	4	valve guide
1.2.7	0.000.0000.1		cannot be supplied
1.2.8	0.010.2636.2	4	special bushing
1.3	0.009.4545.1	1	plug
4	0.010.2633.1	14	screw
5	0.010.2635.2	1	gasket
6	0.009.4541.2	2	bracket
7	0.010.2633.0	2	screw

01011-001E 47CV

Section: ENGINE
CYLINDER HEAD

Fig.	P/n	QTY	Name
------	-----	-----	------

Notes:
[R1.50]

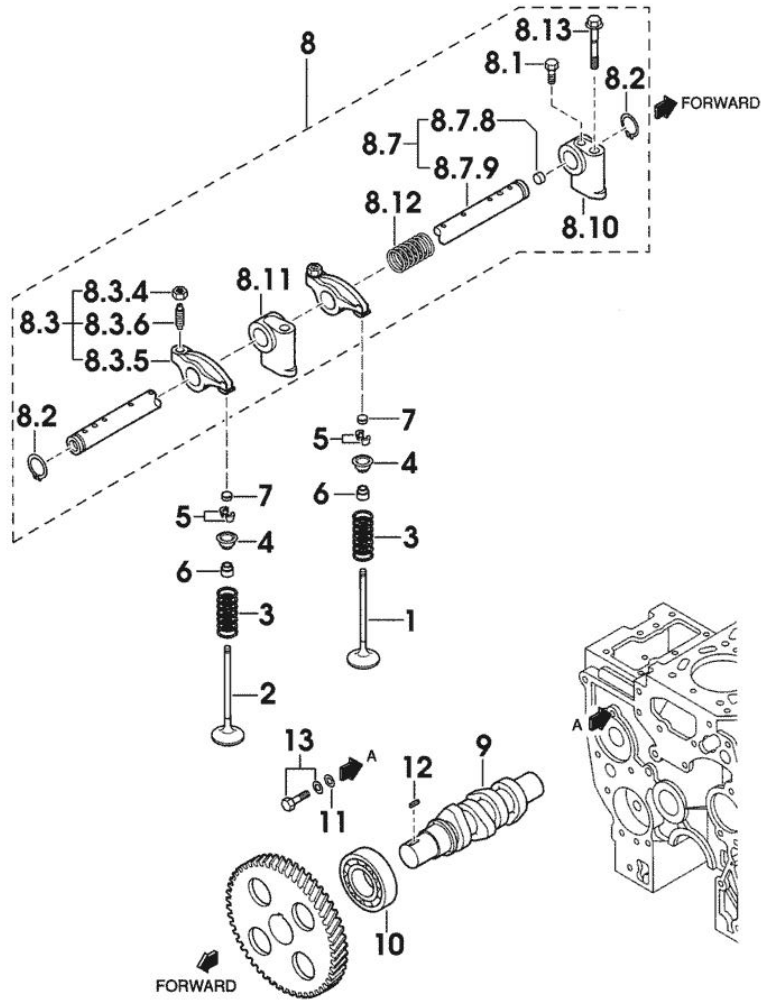

1	0.010.2637.2	4	inlet valve Ø mm 6.5
2	0.010.2638.0	4	exhaust valve Ø mm 6.5
3	0.010.2638.1	8	spring
4	0.010.3992.2	8	cup
5	0.009.4561.2	16	stop
6	0.009.4562.0	8	gasket
7	0.010.2639.0	8	cap
8	0.000.0000.1	1	cannot be supplied
8.1	0.010.2640.1	1	screw
8.2	0.009.4559.0	2	ring
8.3	0.010.3949.0	8	rocker arm
8.3.4	0.010.2641.0	8	nut
8.3.5	0.000.0000.1		cannot be supplied
8.3.6	0.010.3949.1	8	register
8.7	0.010.2644.1	1	shaft
8.7.8	0.010.2643.0	2	plug
8.7.9	0.000.0000.1		cannot be supplied
8.10	0.010.2642.0	1	support
8.11	0.010.2642.1	3	support
8.12	0.010.2643.1	3	spring
8.13	0.010.2643.2	4	screw
9	0.010.2644.0	1	camshaft
10	0.009.4567.0	1	special bearing
11	0.009.4566.0	1	washer
12	0.009.4567.2	1	stick
13	0.010.2639.1	1	screw

01021-013E

Section: ENGINE

CYLINDER HEAD COVER

Fig.	P/n	QTY	Name
------	-----	-----	------

Notes:
[R1.50]

1	0.010.2647.1	1	cover
1.1	0.000.0000.1		cannot be supplied
1.2	0.000.0000.1		cannot be supplied
2	0.010.2647.2	1	gasket
3	0.010.2645.2	5	screw
4	0.009.4548.0	1	plug
5	0.009.4781.2	1	tube
6	0.010.2206.0	1	clamp

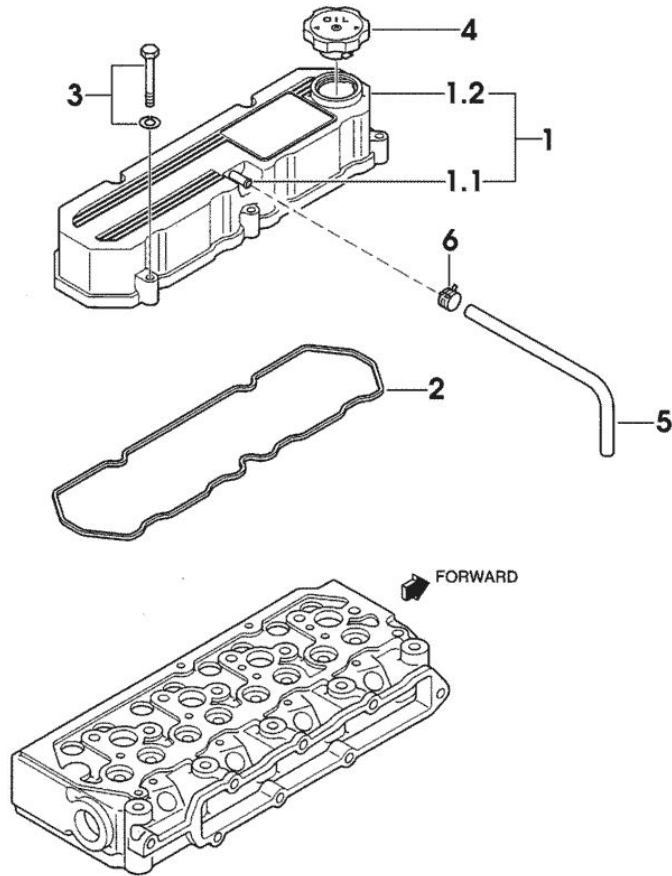

01031-015E

CAMSHAFT

Fig.	P/n	QTY	Name
------	-----	-----	------

Notes:
[R1.50]

1	0.010.3949.2	1	camshaft
2	0.009.4555.1	1	key
3	0.010.3950.0	1	small plate
4	0.010.2639.1	2	screw
5	0.010.3950.1	8	tappets
6	0.010.2646.2	8	rod

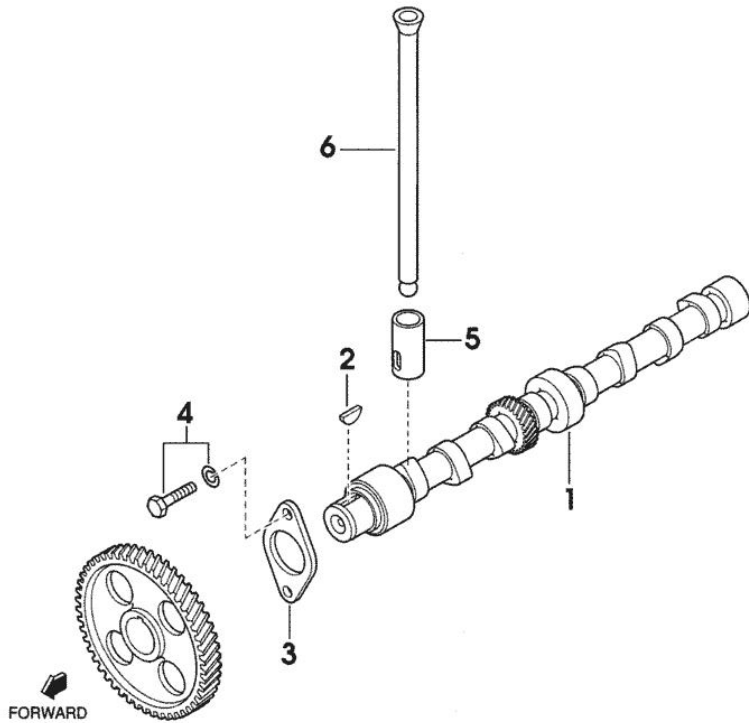

01031-016E

Section: ENGINE

CRANKCASE

Fig.	P/n	QTY	Name
------	-----	-----	------

Notes:
[R1.50]

1	0.010.3986.2	1	crankcase
1.2	0.000.0000.1		cannot be supplied
1.2.1	0.010.2652.1	3	special bushing
1.2.2	0.010.2652.2	3	special bushing
1.2.3	0.010.2653.0	10	screw
1.2.4	0.010.2653.1	1	special bushing
1.2.5	0.000.0000.1		cannot be supplied
1.2.5.6	0.000.0000.1		cannot be supplied
1.2.5.7	0.000.0000.1		cannot be supplied
1.2.5.8	0.000.0000.1		cannot be supplied
1.2.5.9	0.000.0000.1		cannot be supplied
1.2.5.10	0.000.0000.1		cannot be supplied
1.2.11	0.000.0000.1		cannot be supplied
1.3	0.009.4523.2	1	guide
1.4	0.010.2649.0	1	plug
1.5	0.010.2649.1	3	special bushing
1.6	0.009.4545.1	1	plug
1.7	0.009.4524.2	4	special bushing
1.8	0.009.4525.1	2	special bushing
1.9	0.009.4525.2	1	special bushing
1.10	0.009.4524.1	1	expansion plug
1.11	0.010.3951.0	1	pin
1.12	0.009.4523.0	2	pin
1.13	0.010.2650.0	1	pin
1.13.1	0.010.2650.1	1	ball
1.13.2	0.000.0000.1		cannot be supplied
1.15	0.010.2651.0	2	pin
1.16	0.010.2651.1	1	plug
1.17	0.010.3961.2	4	sprayers
18	0.010.2648.1	4	screw
20	0.010.2651.2	4	gasket

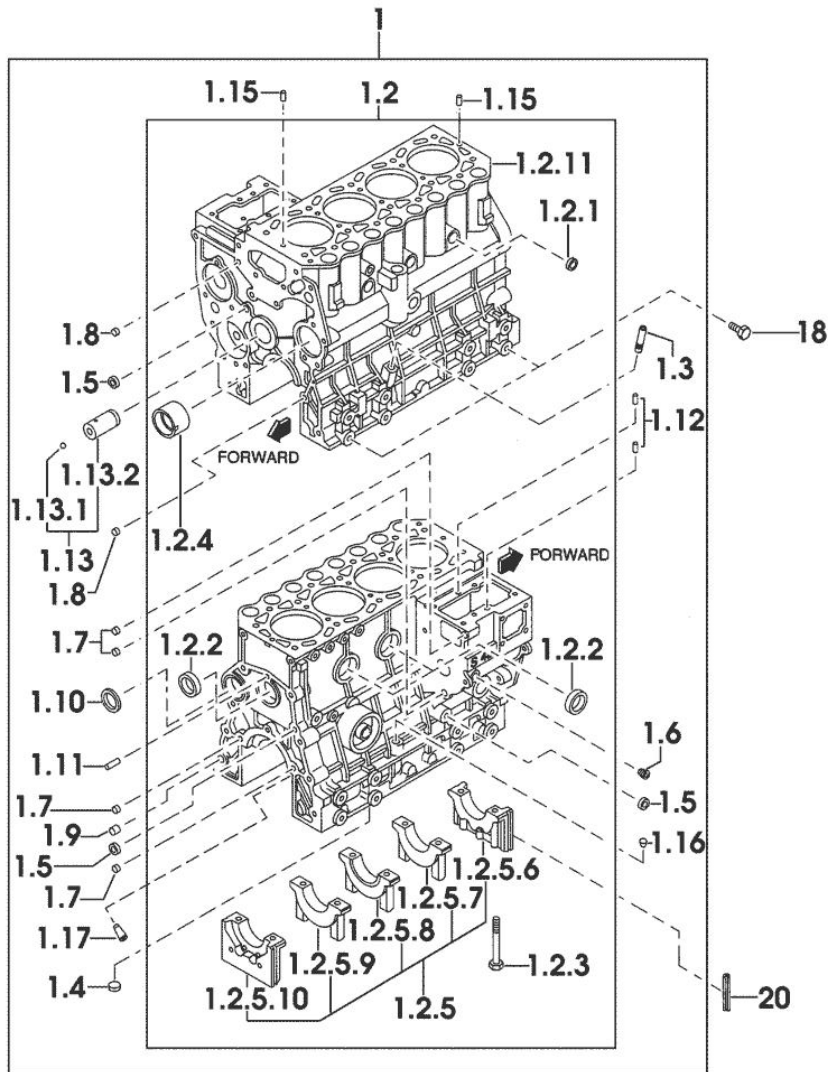

01041-019E 47CV

MAIN BEARINGS

Fig.	P/n	QTY	Name
------	-----	-----	------

Notes:
[R1.50]

1	0.010.2656.2	1	main half bushing STANDARD
2	0.010.2657.0	1	main half bushing - mm 0.25
3	0.010.2657.1	1	main half bushing - mm 0.50
4	0.010.2657.2	1	main half bushing - mm 0.75

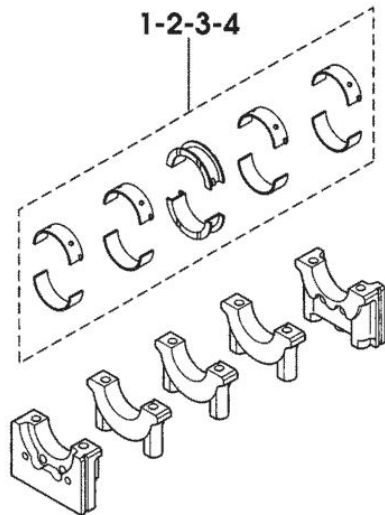
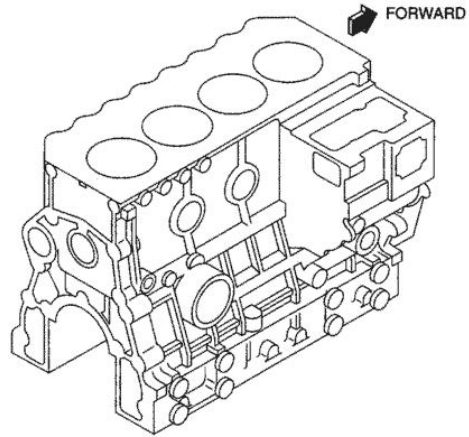

0104B1-001E

Section: ENGINE

TIMING CASE

Fig.	P/n	QTY	Name
------	-----	-----	------

Notes:

[R1.50]

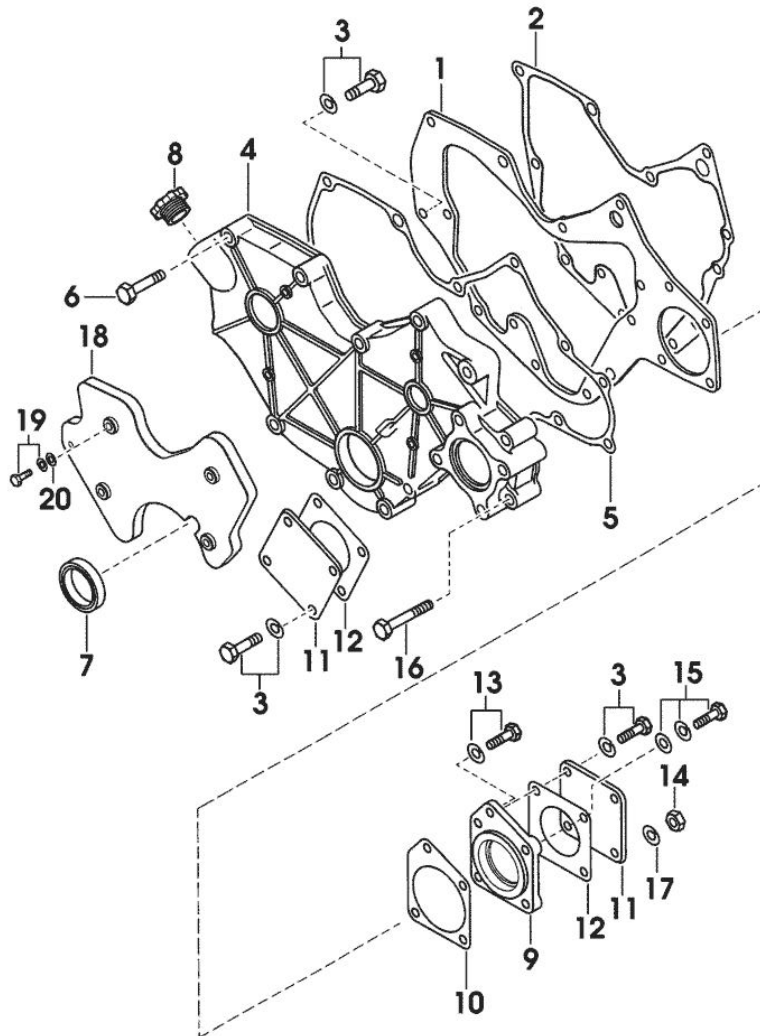

1	0.010.2658.0	1	plate
2	0.010.2658.1	1	gasket
3	0.010.2639.1	10	screw
4	0.010.3951.1	1	flange
5	0.010.2659.0	1	gasket
6	0.010.2659.1	8	screw
7	0.009.4537.0	1	gasket
8	0.010.3951.2	1	plug
9	0.010.2660.0	1	flange
10	0.010.2660.1	1	gasket
11	0.009.4756.0	2	cover
12	0.010.3952.0	2	gasket
13	0.010.2661.0	1	screw
14	0.010.2661.1	2	nut
15	0.010.3952.1	1	screw
16	0.010.3952.2	2	screw
17	0.009.4539.2	2	spring washer
18	0.010.3953.0	1	cover
19	0.010.2662.2	4	screw
20	0.010.2663.0	4	washer

01051-018

Buy Now



Our support email:

ebooklibonline@outlook.com