

VA Tractors

Operators Manual

RI-53

Reprinted

CASE III





THIS SAFETY ALERT SYMBOL INDICATES IMPORTANT SAFETY MESSAGES IN THIS MANUAL. WHEN YOU SEE THIS SYMBOL, CAREFULLY READ THE MESSAGE THAT FOLLOWS AND BE ALERT TO THE POSSIBILITY OF PERSONAL INJURY OR DEATH.

M171B

If Safety Decals on this machine use the words **Danger, Warning or Caution**, which are defined as follows:

- **DANGER:** Indicates an immediate hazardous situation which if not avoided, will result in death or serious injury. The color associated with Danger is RED.
- **WARNING:** Indicates an potentially hazardous situation which if not avoided, will result in serious injury. The color associated with Warning is ORANGE.
- **CAUTION:** Indicates an potentially hazardous situation which if not avoided, may result in minor or moderate injury. It may also be used to alert against unsafe practices. The color associated with Caution is YELLOW.

If Safety Decals on this machine are ISO two panel Pictorial, decals are defined as follows:

- The first panel indicates the nature of the hazard.
- The second panel indicates the appropriate avoidance of the hazard.
- Background color is YELLOW.
- Prohibition symbols such as   and  if used, are RED.



WARNING

IMPROPER OPERATION OF THIS MACHINE CAN CAUSE INJURY OR DEATH. BEFORE USING THIS MACHINE, MAKE CERTAIN THAT EVERY OPERATOR:

- Is instructed in safe and proper use of the machine.
- Reads and understands the Manual(s) pertaining to the machine.
- Reads and understands ALL Safety Decals on the machine.
- Clears the area of other persons.
- Learns and practices safe use of machine controls in a safe, clear area before operating this machine on a job site.

It is your responsibility to observe pertinent laws and regulations and follow Case Corporation instructions on machine operation and maintenance.



**VA Tractors
Operators Manual**

Rac 53 6th

J I Case
A Tenneco Company



TO PURCHASERS OF CASE TRACTORS

Congratulations on your purchase of a Case Tractor and welcome to the ever-increasing number of satisfied Case Owners.

The dependability and economical performance of your new Case Tractor will prove that you were wise in making this choice.

The organization back of your tractor has been building quality farm equipment for more than a century. Your Case Tractor was built in one of the largest and best equipped plants in the world. In this factory quality materials, precision machinery, high grade workmanship, thorough inspection, and complete testing equipment are combined to give you the best in performance and economical operation.

The care which you give your tractor will have a great deal to do with the service and satisfaction you get from it. By observing the precautions and suggestions in this manual, your Case Tractor will serve you well for many years. Make this manual your guide. Should you need information not covered here, or should your tractor require special servicing, contact your Case Dealer. He has trained men who are kept informed on the best methods of servicing Case Farming Equipment in the field or in his shop.

When it becomes necessary, after long use, to replace certain parts on your tractor, be sure to use only genuine Case Parts, which insure proper fit and continued good service. These may be obtained from your Case Dealer. It is always helpful to provide him with the Model and Serial Number of your tractor in addition to a description and part number, if available, of the parts required.

PRICE \$1.25

TABLE OF CONTENTS

Section	Page
SERIAL NUMBER	6
I GENERAL SPECIFICATIONS	7
II LUBRICATION	13
Recommended Engine, Transmission and Hydraulic Lubricants	15
Lubrication Points	16
Engine Lubrication	18
Transmission Lubrication	21
Hydraulic System	22
III OPERATING INSTRUCTIONS	23
Important Pre-starting Information	25
Starting Instructions	27
Rear Wheel Traction	30
Wheel Spacing	32
Low Cost Fuel Tractors	36
Fuels and Fuel Storage	38
Drawbar	40
Power Take-off	41
Belt Pulley Work	42
Eagle Hitch	45
Hydraulic Control Unit	50
Remote or Portable Cylinder Control	51
Periodic Checks During Operation	55
IV MAINTENANCE	57
Lubrication	59
Cooling System	59
Air Cleaner	64
Crankcase Breather	64
Transmission Breather	64
Fuel Strainer	65
Carburetor	65
Governor and Engine Speed	68
Valve Clearance	70
Oil Pump	70
Ignition and Electrical Equipment	72
Distributor	73
Magneto	75
Spark Plugs	78
Ignition Coil	79
Starting and Lighting Equipment	79
Steering Gear	83
Repacking and Adjusting Front Wheel Bearings	84
Differential Brake Adjustment	85
Clutch Adjustment	87
V SERVICE SUGGESTIONS	89
Tractor Storage	94
INDEX	96

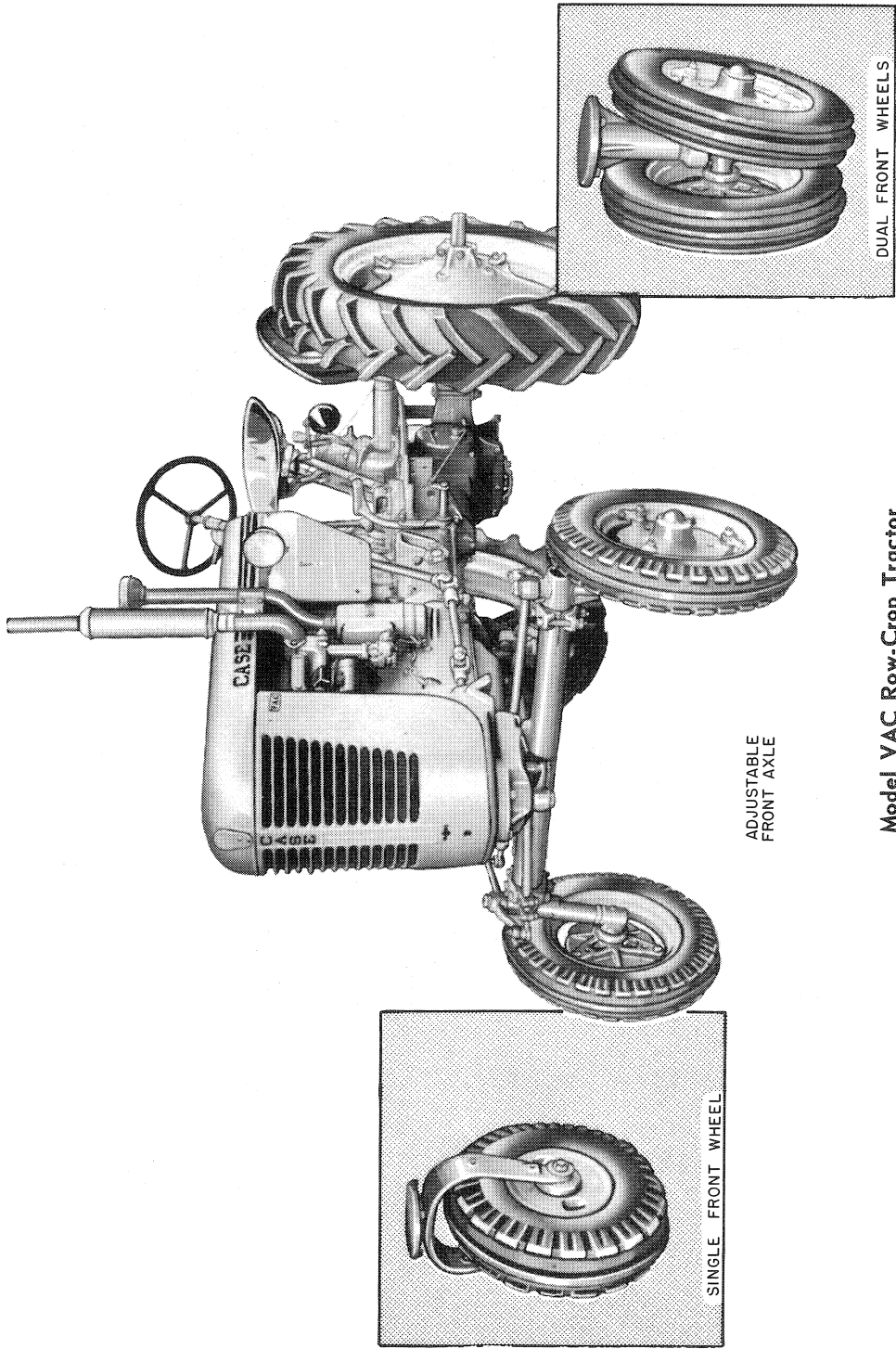

ADJUSTABLE
FRONT AXLE

Model VAC Row-Crop Tractor

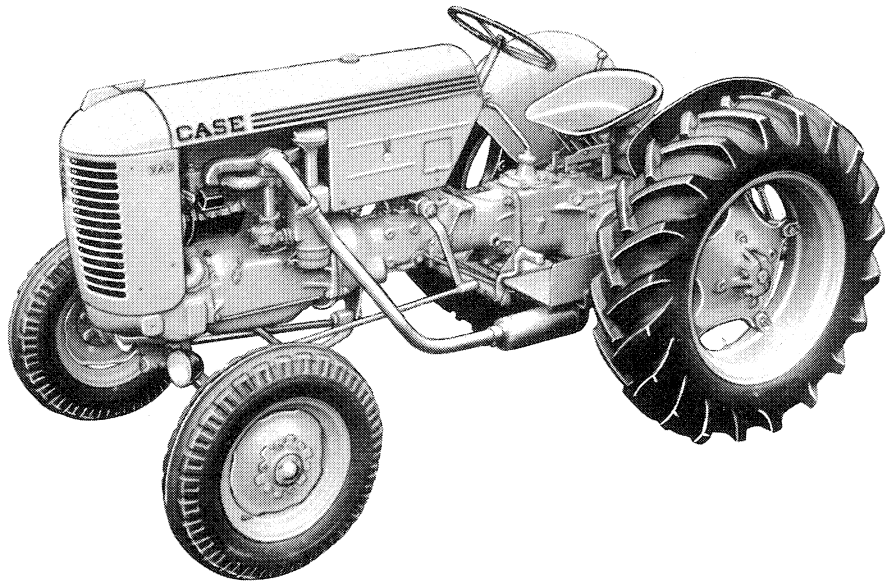

Model VAO — Orchard Tractor

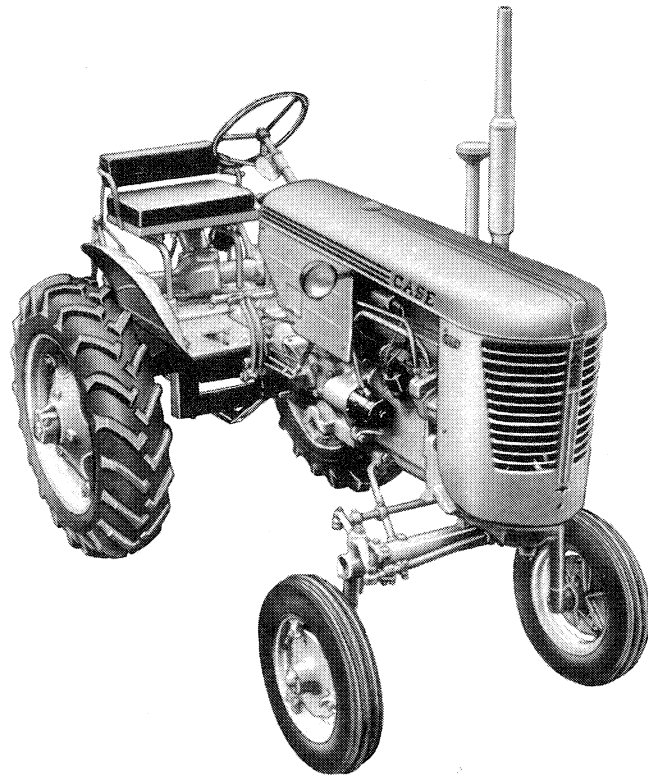

Model VAS — Off-Set High-Clearance Tractor

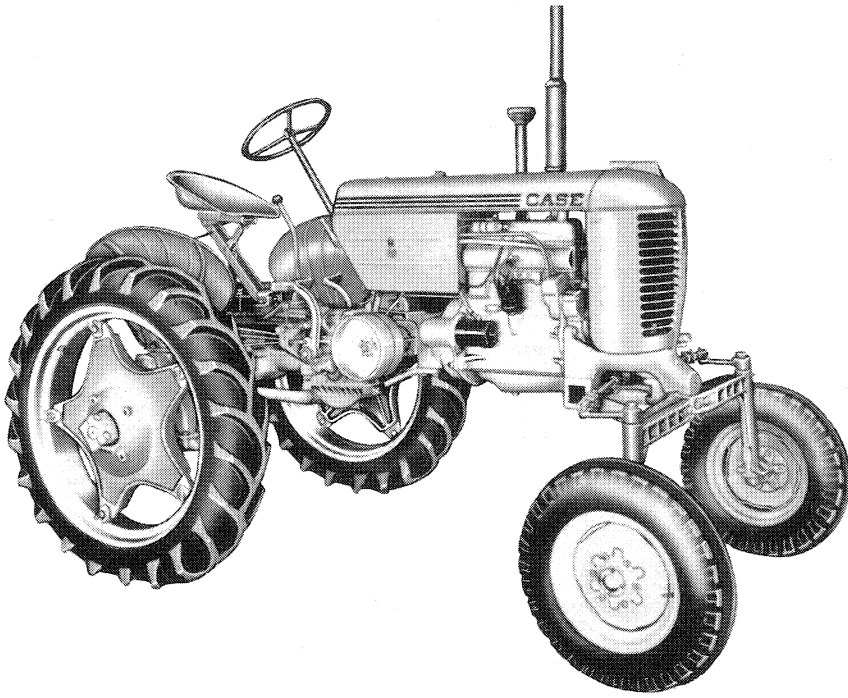

Model VAH — High-Clearance Tractor

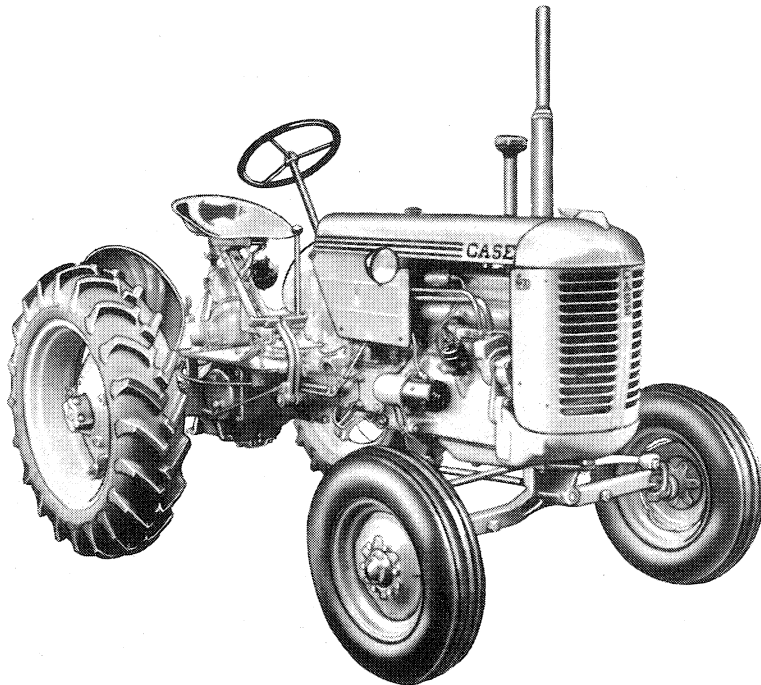

Model VA — General Purpose Tractor

Buy Now



Our support email:

ebooklibonline@outlook.com