



# Bobcat®

---

## Service Manual

# Three-Point Rotary Cutter

---

**(3RC60SB) S/N AL1M00101 & Above**  
**(3RC60SC) S/N AL1K00101 & Above**  
**(3RC72SB) S/N AL1N00101 & Above**  
**(3RC72SC) S/N AL1L00101 & Above**

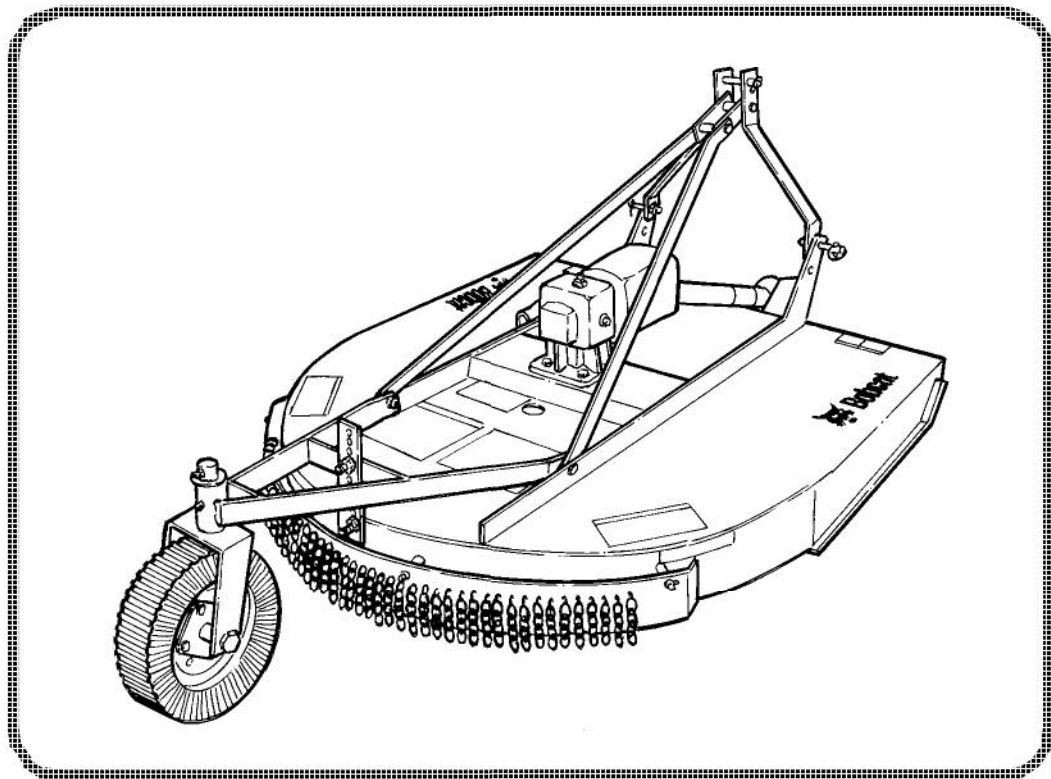

Dealer Copy -- Not for Resale

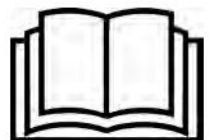

# MAINTENANCE SAFETY



## WARNING







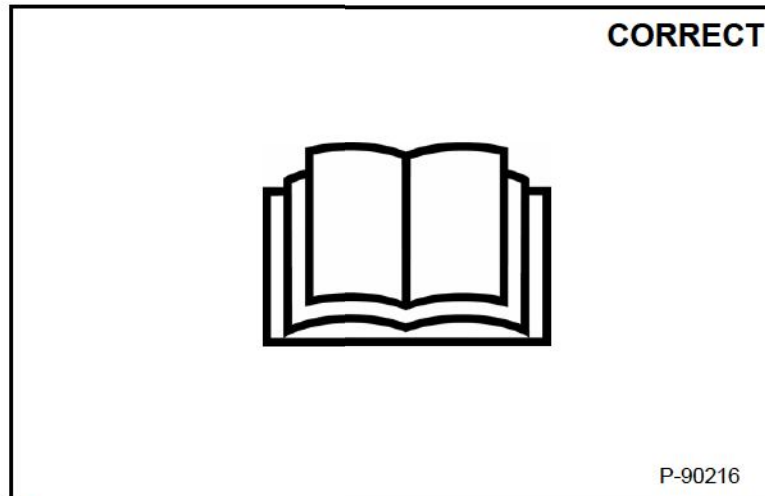

Instructions are necessary before operating or servicing machine. Read and understand the Operation & Maintenance Manual, Operator's Handbook and signs (decals) on machine. Follow warnings and instructions in the manuals when making repairs, adjustments or servicing. Check for correct function after adjustments, repairs or service. Untrained operators and failure to follow instructions can cause injury or death.

W-2003-0807



**Safety Alert Symbol:** This symbol with a warning statement, means: "Warning, be alert! Your safety is involved!" Carefully read the message that follows.



-  Never service attachments / implements without instructions. See Operation & Maintenance Manual and Attachment / Implement Service Manual.
-  Cleaning and maintenance are required daily.
-  Never service or adjust attachment / implement with the engine running unless instructed to do so in manual.
-  Always lower the attachment / implement to the ground before lubricating or servicing.
-  Avoid contact with leaking hydraulic fluid or diesel fuel under pressure. It can penetrate skin or eyes.
-  Stop, cool and clean engine of flammable materials before checking fluids.
-  Keep body, loose objects and clothing away from moving parts, electrical contacts, hot parts and exhaust.
-  Safety glasses are needed for eye protection from electrical arcs, battery acid, compressed springs, fluids under pressure and flying debris or when tools are used. Use eye protection approved for type of welding.

Dealer Copy -- Not for Resale

MSW30-0409

## CONTENTS

SAFETY & MAINTENANCE .....	10-01
MAINFRAME .....	20-01
SPECIFICATIONS .....	SPEC-01
ALPHABETICAL INDEX .....	INDEX-01

Dealer Copy -- Not for Resale

## FOREWORD

SERIAL NUMBER LOCATION .....	1-7
Implement Serial Number .....	1-7
MANUAL STORAGE LOCATION .....	1-7
DELIVERY REPORT .....	1-7
IMPLEMENT IDENTIFICATION .....	1-8
IMPLEMENT SIGNS (DECALS) .....	1-9

## SERIAL NUMBER LOCATION

### Implement Serial Number

Figure 1

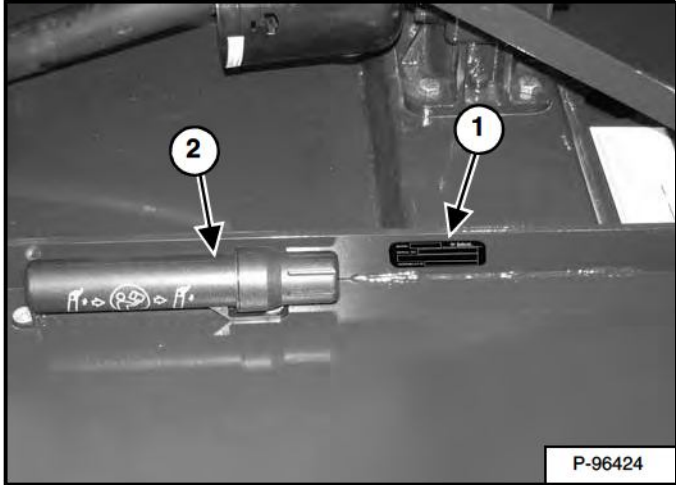

Always use the serial number (Item 1) [Figure 1] of the three-point rotary cutter when requesting service information or when ordering parts. Early or later models (identification made by serial number) may use different parts, or it may be necessary to use a different procedure in doing a specific service operation.

## MANUAL STORAGE LOCATION

Read and understand the Operation & Maintenance Manual before operating the three-point rotary cutter.

The Operation & Maintenance Manual and Safety Manual(s) are stored in a container (Item 2) [Figure 1] located on the three-point rotary cutter.

## DELIVERY REPORT

Figure 2

A schematic diagram of a 'DELIVERY REPORT' form. The form is divided into several sections. At the top right is the title 'DELIVERY REPORT'. Below it is a section with multiple lines for text entry. To the left of this section is a box labeled 'WARNING' with a black background and white text. Below the 'WARNING' box is another section with multiple lines for text entry. In the bottom right corner of the form, there is a small box containing the reference number 'B-16315'.

The delivery report [Figure 2] must be completed by the dealer and signed by the owner or operator when the Bobcat three-point rotary cutter is delivered. An explanation of the form must be given to the owner.

Dealer Copy -- Not for Resale

**IMPLEMENT IDENTIFICATION**

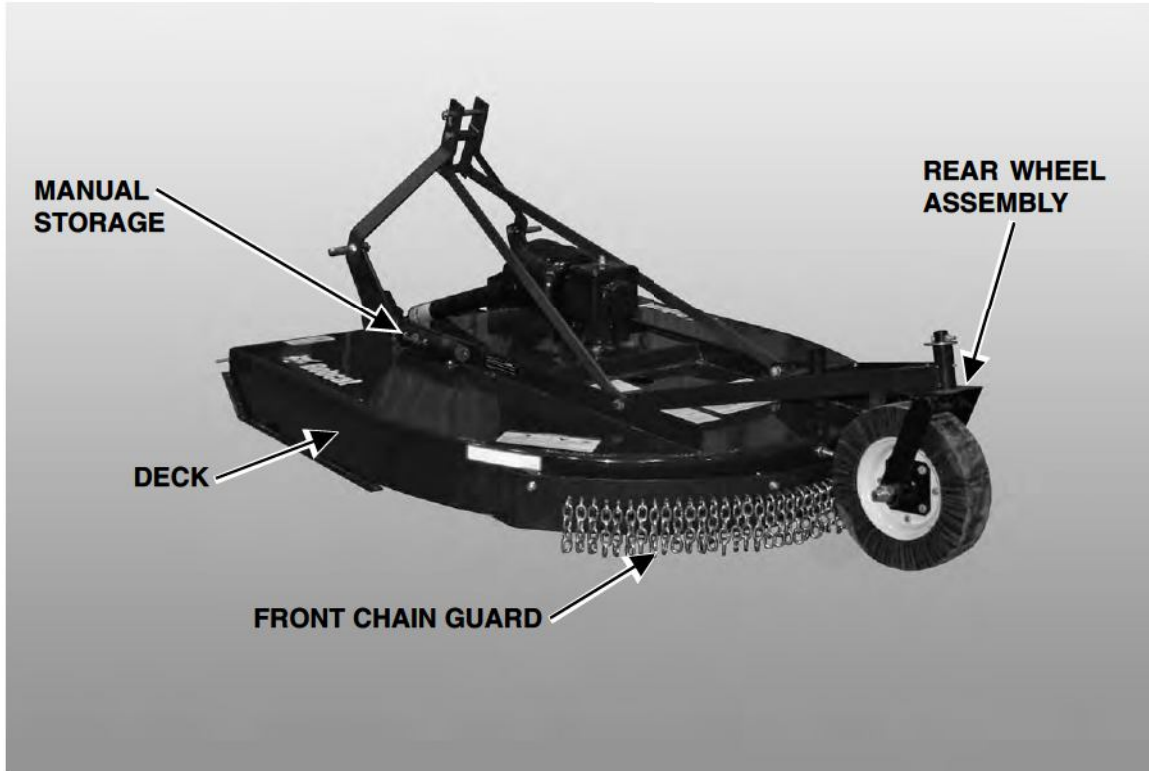

P-96425

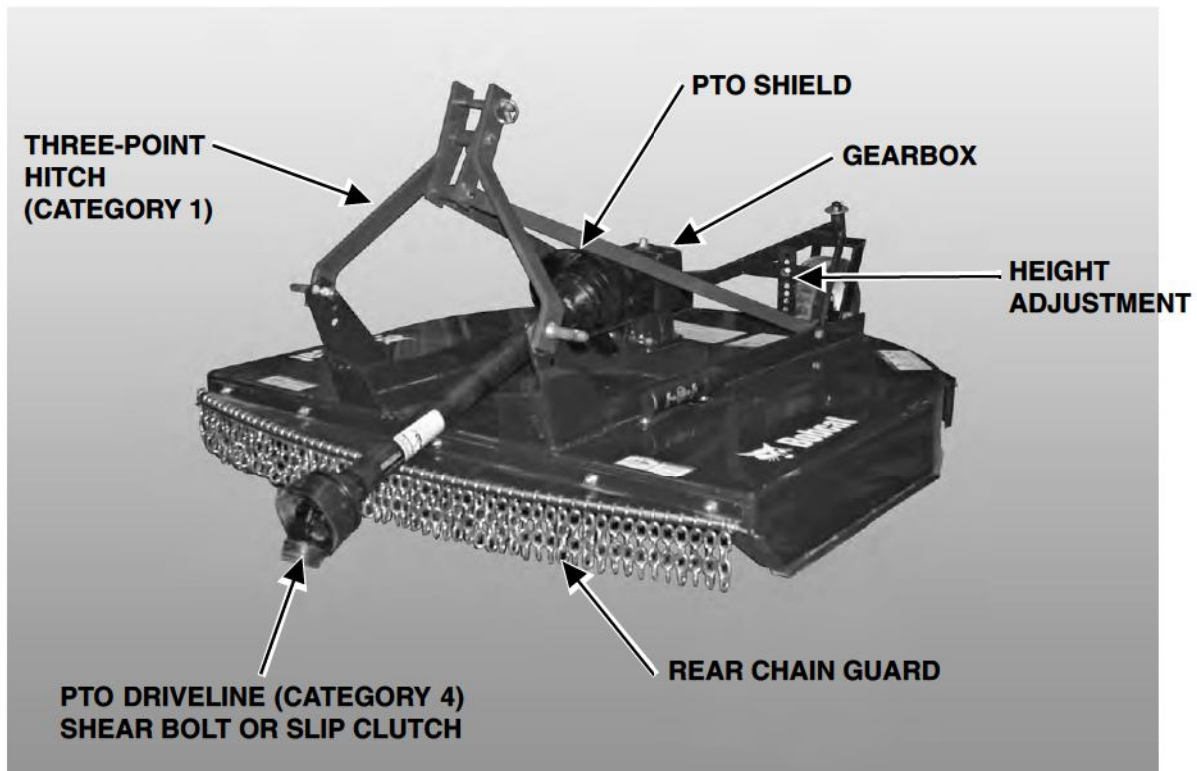





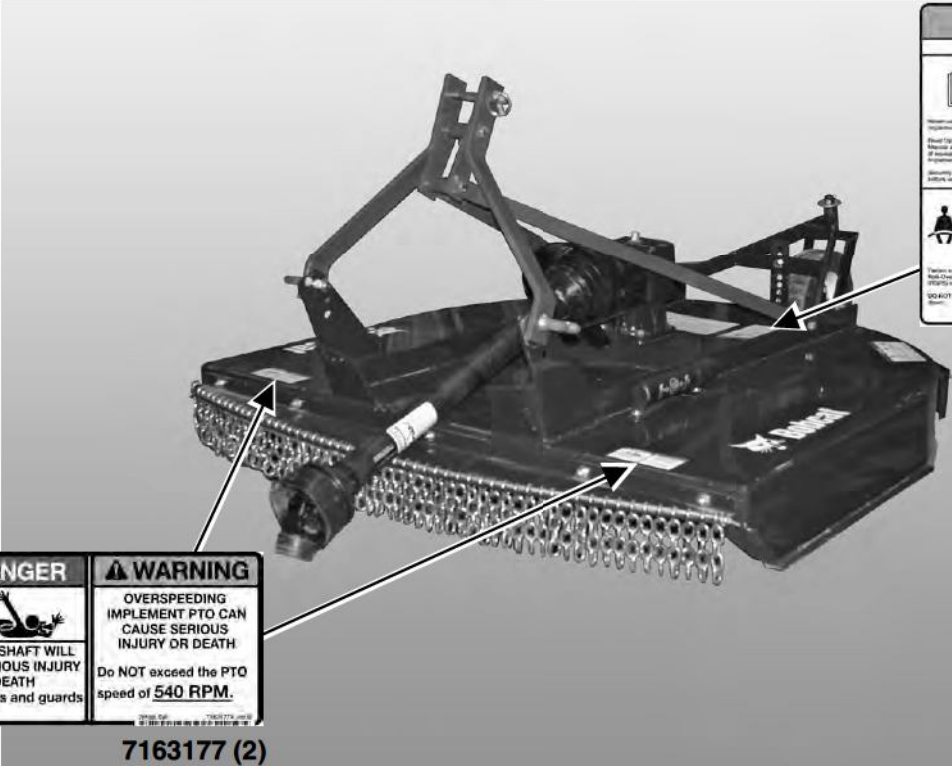

P-96407

Dealer Copy -- Not for Resale

## IMPLEMENT SIGNS (DECALS)

Follow the instructions on all the Implement Signs (Decals) that are on the implement. Replace any damaged implement signs and be sure they are in the correct locations. Implement signs are available from your Bobcat Implement dealer.





<b>WARNING</b> AVOID SERIOUS INJURY OR DEATH		
 <p>Read and understand all instructions before operating this implement without assistance.</p> <p><b>Read Operation &amp; Maintenance Manual</b> and operator's location of equipment for correct use and adjustment.</p> <p>Security blocks on the implement when working unattended.</p>	 <p>Never PTO (power take-off) shaft, mounting plate, and drive shaft in open.</p> <p>Keep away from moving parts.</p> <p>Always disengage PTO.</p> <p>Always disengage <b>ONLY</b> after PTO BRASS OF THE PTO.</p>	 <p>Observe all traffic regulations when on public roads. Use slow moving vehicle (SMV) emblem and flashing lights when required.</p> <p>Load limits apply to all implements.</p> <p>Always use proper tie-down technique.</p>
 <p>Person will fall severely when not over minimum safe height (PSH) in up and down.</p> <p><b>DO NOT</b> use seat belt if PTO is down.</p>	 <p><b>USE PTO'S AND AXLES REAR SIDE.</b></p> <p>Drive down when turning and operating in rough ground or ruts.</p>	<p><b>TO LEAVE CONTRACT TRACTOR:</b></p> <ol style="list-style-type: none"> <li>1. Lower all implements to the ground.</li> <li>2. Move all controls to neutral.</li> <li>3. Lock master parking brake and chock parking brake.</li> <li>4. Shut engine and remove key.</li> </ol>

**7139395**

**7163177 (2)**

P-96407

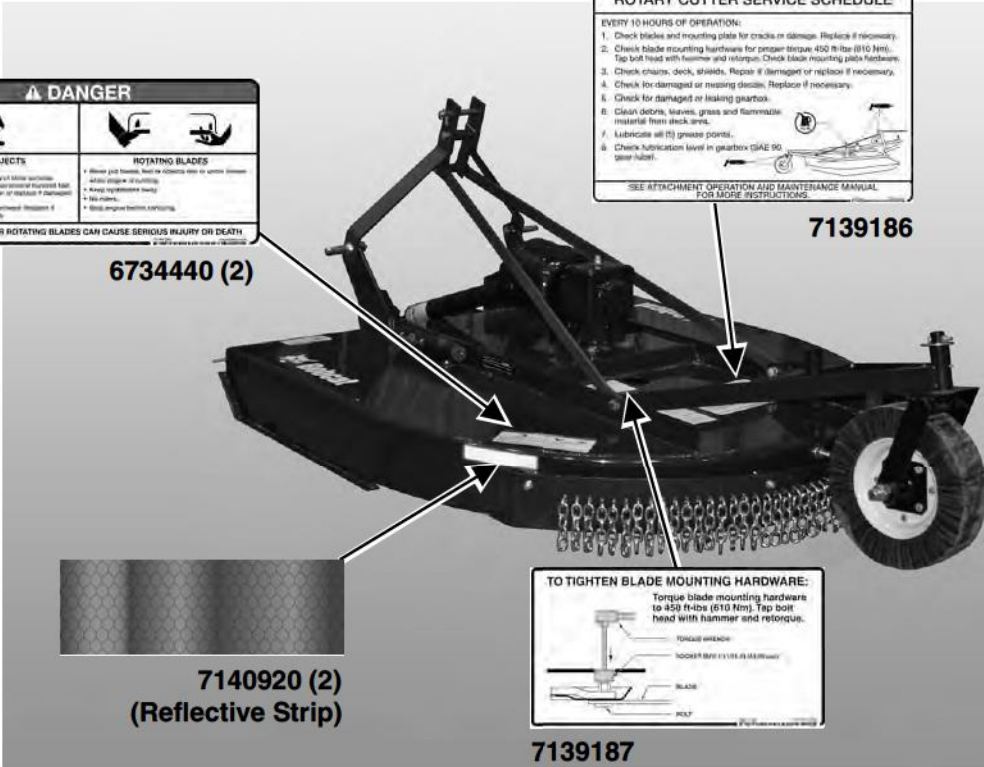

---

<b>DANGER</b>	
 <p><b>ROTATING SHAFT WILL CAUSE SERIOUS INJURY OR DEATH</b></p> <p>Keep shields and guards in place.</p>	 <p><b>OVERSPEEDING IMPLEMENT PTO CAN CAUSE SERIOUS INJURY OR DEATH</b></p> <p>Do <b>NOT</b> exceed the PTO speed of <b>540 RPM</b>.</p>



**7140920 (2) (Reflective Strip)**

P-96425

<b>DANGER</b>	
 <p><b>THROWN OBJECTS</b></p> <ul style="list-style-type: none"> <li>• Clear working area of debris.</li> <li>• Always wear seat belt or safety harness when operating.</li> <li>• Always use the correct PTO shaft and hardware.</li> <li>• Always use the correct PTO shaft and hardware.</li> <li>• Check blades and mounting hardware frequently if damaged, loose, bent or broken.</li> </ul>	 <p><b>ROTATING BLADES</b></p> <ul style="list-style-type: none"> <li>• Always use shields, feet or distance rods to open doors when changing blades.</li> <li>• Always disengage PTO.</li> <li>• Always use proper tie-down technique.</li> <li>• Use proper tie-down technique.</li> </ul>

**THROWN OBJECTS OR ROTATING BLADES CAN CAUSE SERIOUS INJURY OR DEATH**

**7139186**

**7139187**

**7139187**

**ROTARY CUTTER SERVICE SCHEDULE**

EVERY 10 HOURS OF OPERATION:

1. Check blades and mounting plate for cracks or damage. Replace if necessary.
2. Check blade mounting hardware for proper torque (450 ft-lbs (610 Nm)). Tap bolt head with hammer and retorquing. Check blade mounting plate hardware.
3. Check chains, deck, shields. Repair if damaged or replace if necessary.
4. Check for damaged or missing decals. Replace if necessary.
5. Check for damaged or leaking gearbox.
6. Clean debris, leaves, grass and flammable material from deck area.
7. Lubricate all (5) grease points.
8. Check lubrication level in gearbox (SAE 90 gear oil).

SEE ATTACHMENT OPERATION AND MAINTENANCE MANUAL FOR MORE INSTRUCTIONS.

**TO TIGHTEN BLADE MOUNTING HARDWARE:**

Torque blade mounting hardware to 450 ft-lbs (610 Nm). Tap bolt head with hammer and retorquing.



## SAFETY & MAINTENANCE

TROUBLESHOOTING .....	10-10-1
Chart .....	10-10-1
SERVICE SCHEDULE .....	10-20-1
Chart .....	10-20-1
Description .....	10-20-1
LUBRICATING THE IMPLEMENT .....	10-30-1
Lubrication Locations .....	10-30-1
REMOVAL AND INSTALLATION OF CHAIN GUARDS .....	10-40-1
Procedure .....	10-40-1
REMOVAL AND INSTALLATION OF SHEAR BOLT (GRADE 2) .....	10-50-1
Procedure .....	10-50-1
IMPLEMENT STORAGE AND RETURN TO SERVICE .....	10-60-1
Storage .....	10-60-1
Return to Service .....	10-60-1
REGULAR MAINTENANCE ITEMS .....	10-70-1
Gearbox Fluid .....	10-70-1
Cleaning The Three-Point Rotary Cutter .....	10-70-1

Dealer Copy -- Not for Resale



## TROUBLESHOOTING

### Chart

 <b style="font-size: 24pt; margin-left: 10px;">WARNING</b>	<p>Instructions are necessary before operating or servicing machine. Read and understand the Operation &amp; Maintenance Manual, Operator's Handbook and signs (decals) on machine. Follow warnings and instructions in the manuals when making repairs, adjustments or servicing. Check for correct function after adjustments, repairs or service. Untrained operators and failure to follow instructions can cause injury or death.</p> <p style="text-align: right; font-size: 10pt;">W-2003-0903</p>
--	---

Use the following troubleshooting chart to locate and correct problems which most often occur with the implement.

*(3RC60SB & 3RC72SB) Three-Point Rotary Cutter*

PROBLEM	CAUSE	CORRECTION
Poor cutting.	Travel speed too fast.	Reduce travel speed.
	Debris on blade mounting plate.	Clean mounting plate.
	Blades worn or damaged.	Sharpen or replace blades.
Excessive vibration.	Build up of material.	Clean three-point rotary cutter.
	Broken or missing blade.	Replace blades.
Blades will not rotate.	Debris between blades and mounting plate.	Remove debris.
	Broken shear bolt.	Replace shear bolt.

*(3RC60SC & 3RC72SC) Three-Point Rotary Cutter*

PROBLEM	CAUSE	CORRECTION
Poor cutting.	Travel speed too fast.	Reduce travel speed.
	Debris on blade mounting plate.	Clean mounting plate.
	Blades worn or damaged.	Sharpen or replace blades.
Excessive vibration.	Build up of material.	Clean three-point rotary cutter.
	Broken or missing blade.	Replace blades.
Blades will not rotate.	Debris between blades and mounting plate.	Remove debris.
	PTO slip clutch worn excessively.	See your Bobcat dealer for service.

Dealer Copy -- Not for Resale

***Buy Now***



Our support email:

[ebooklibonline@outlook.com](mailto:ebooklibonline@outlook.com)