

**Combination  
Bucket  
80" & 90"**



**Bobcat®**

**VersaHANDLER  
Attachment  
Service  
Manual**

**S/N 028500101 & Above  
S/N 028700101 & Above**

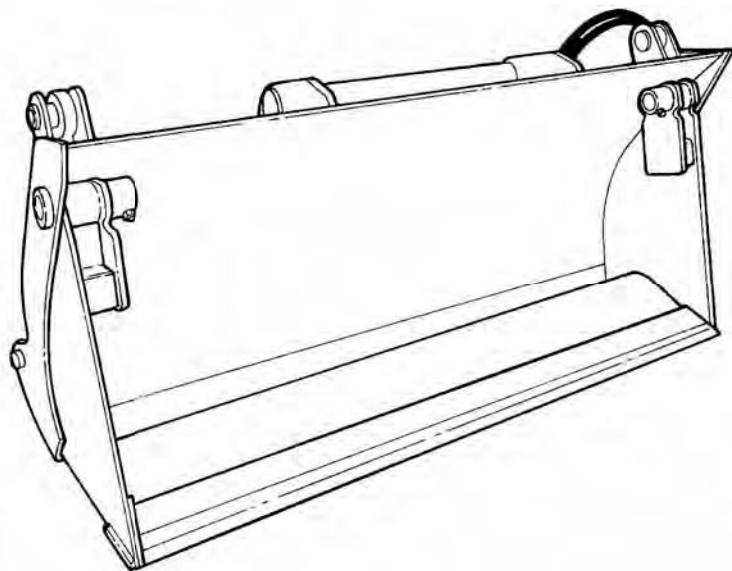

*Doosan purchased Bobcat Company from Ingersoll-Rand Company in 2007. Any reference to Ingersoll-Rand Company or use of trademarks, service marks, logos, or other proprietary identifying marks belonging to Ingersoll-Rand Company in this manual is historical or nominative in nature, and is not meant to suggest a current affiliation between Ingersoll-Rand Company and Bobcat Company or the products of either.*

# MAINTENANCE SAFETY



## WARNING







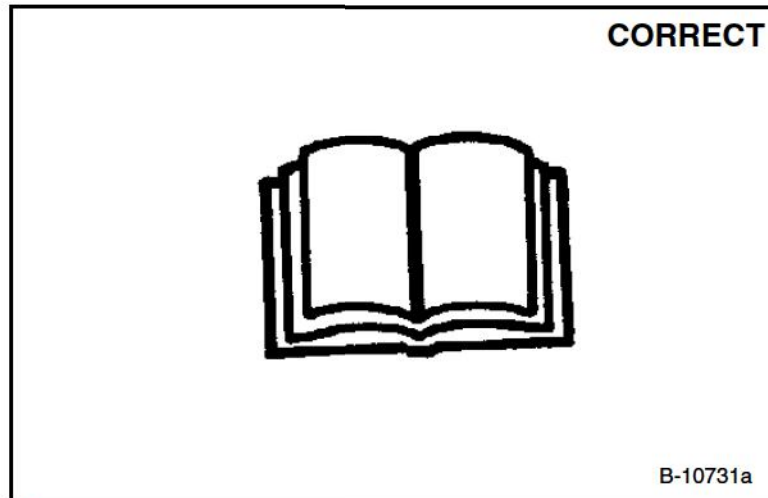

Instructions are necessary before operating or servicing machine. Read and understand the Operation & Maintenance Manual, Operator's Handbook and signs (decals) on machine. Follow warnings and instructions in the manuals when making repairs, adjustments or servicing. Check for correct function after adjustments, repairs or service. Untrained operators and failure to follow instructions can cause injury or death.

W-2003-0903



**Safety Alert Symbol:** This symbol with a warning statement, means: "Warning, be alert! Your safety is involved!" Carefully read the message that follows.



-  Never service attachments without instructions. See Operation & Maintenance Manual and Attachment Service Manual.
-  Cleaning and maintenance are required daily.
-  Never service or adjust attachment with the engine running unless instructed to do so in manual.
-  Always lower the attachment to the ground before lubricating or servicing.
-  Avoid contact with leaking hydraulic fluid or diesel fuel under pressure. It can penetrate skin or eyes.
-  Stop, cool and clean engine of flammable materials before checking fluids.
-  Keep body, loose objects and clothing away from moving parts, electrical contacts, hot parts and exhaust.
-  Safety glasses are needed for eye protection from electrical arcs, battery acid, compressed springs, fluids under pressure and flying debris or when tools are used. Use eye protection approved for type of welding.

## ALPHABETICAL INDEX

CLAM SHELL.....	30-01
GLOSSARY OF HYDRAULIC SYMBOLS .....	40-01
HYDRAULIC CYLINDERS.....	20-01
HYDRAULIC SCHEMATIC .....	40-01
INSPECTION .....	10-01
LOAD CHECK VALVE.....	20-01
LUBRICATION .....	10-01
PARTS IDENTIFICATION .....	IV
SERIAL NUMBER LOCATION.....	III
SPECIFICAITONS .....	40-01
TROUBLESHOOTING .....	10-01

Dealer Copy -- Not for Resale

# CONTENTS

**SAFETY AND  
MAINTENANCE**

**HYDRAULIC  
SYSTEM**

**MAIN  
FRAME**

**SPECIFICATIONS  
AND  
SCHEMATICS**

SERIAL NUMBER LOCATION ..... III

PARTS IDENTIFICATION ..... IV

SAFETY AND MAINTENANCE..... 10-01

HYDRAULIC SYSTEM ..... 20-01

MAIN FRAME ..... 30-01

SPECIFICATIONS AND SCHEMATICS ..... SPEC-01

**CALIFORNIA  
PROPOSITION 65 WARNING**  
Diesel engine exhaust and some of its  
constituents are known to the State of California  
to cause cancer, birth defects and other  
reproductive harm.

Dealer Copy -- Not for Resale

## SERIAL NUMBER LOCATION

Figure 1

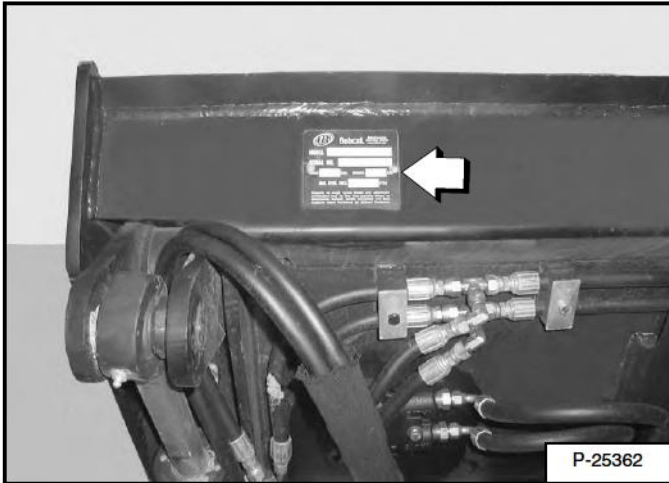

Always use the serial number of the machine when requesting service information or when ordering parts. Early or later models (identification made by serial number) may use different parts, or it may be necessary to use a different procedure in doing a specific service [Figure 1].

PARTS IDENTIFICATION

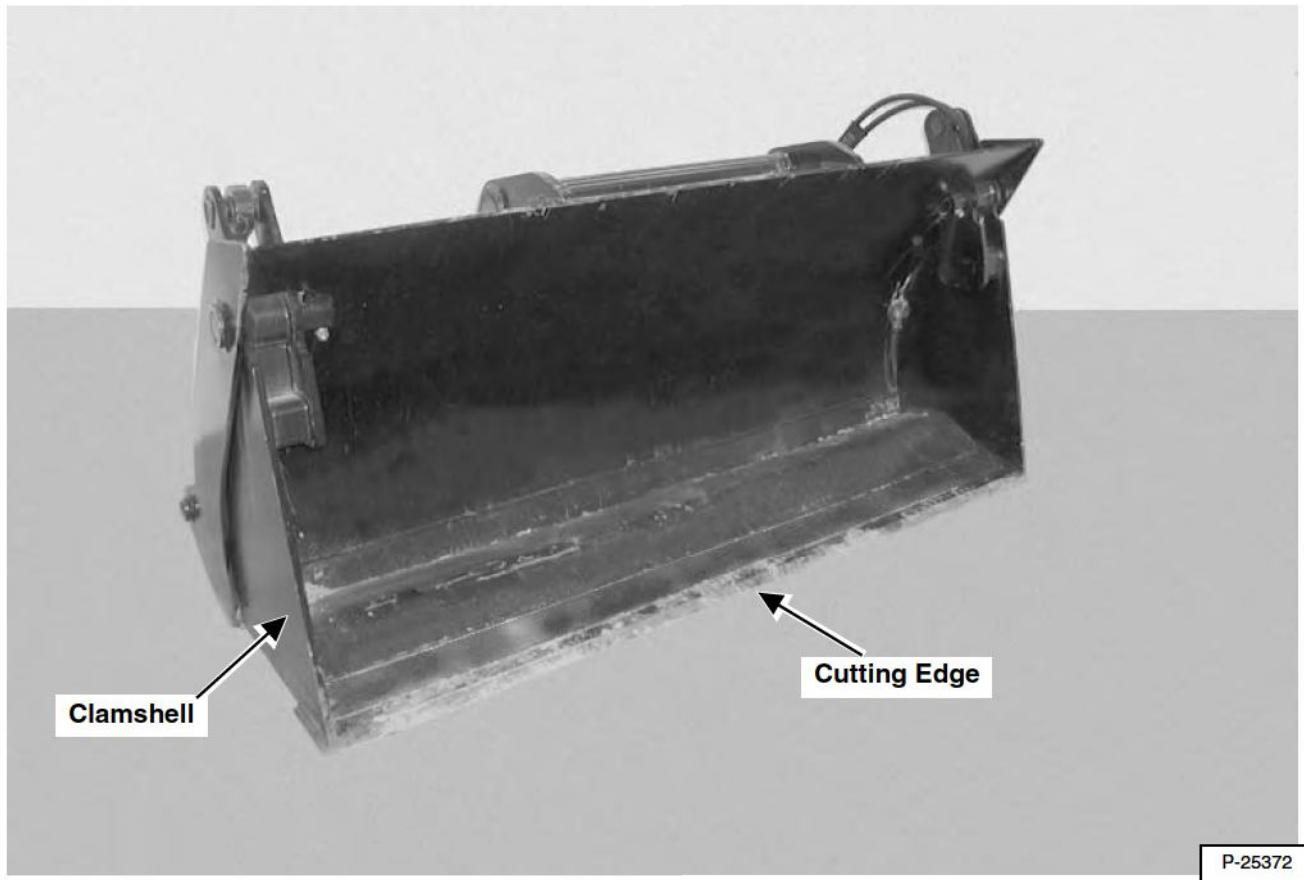
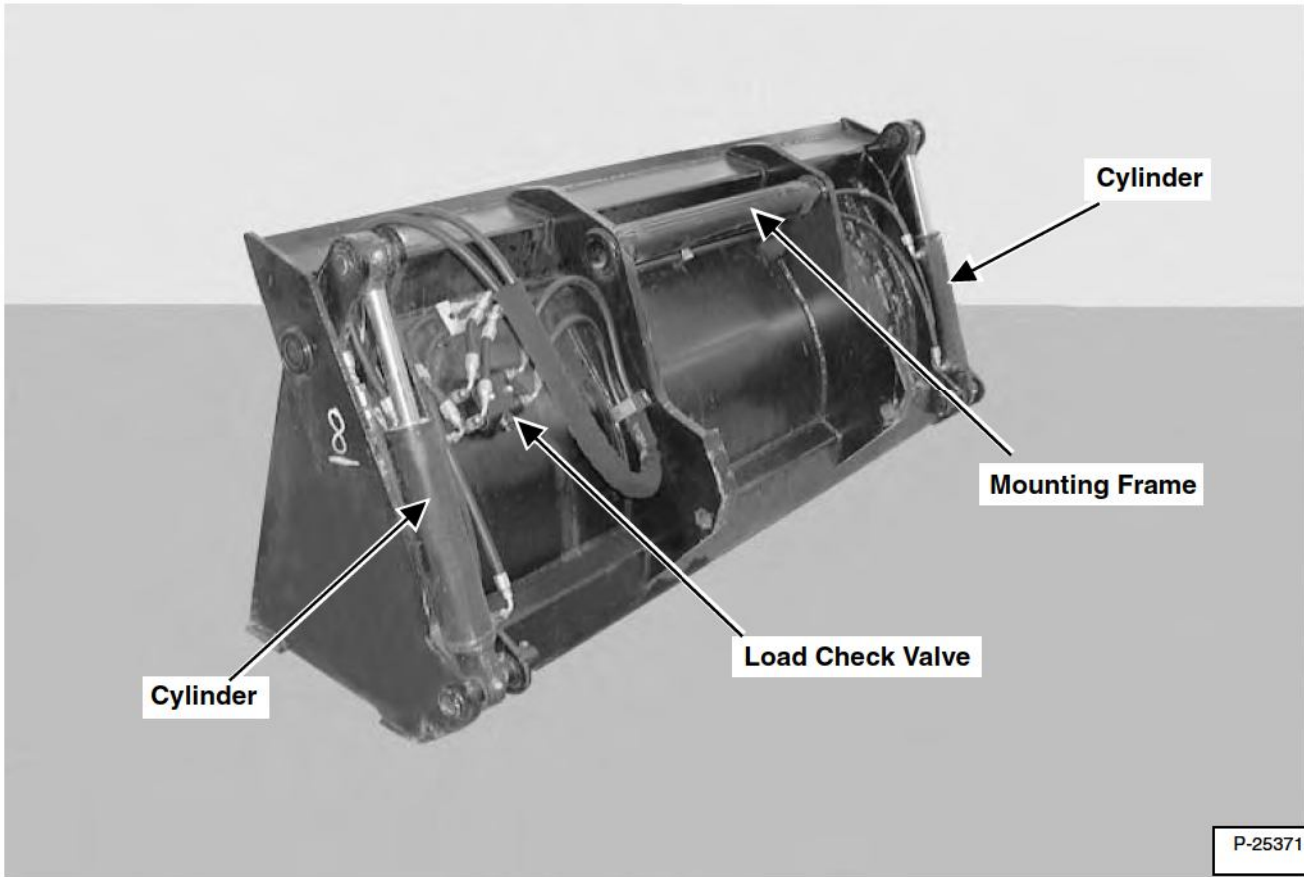

Dealer Copy -- Not for Resale

## SAFETY AND MAINTENANCE

**SAFETY AND  
MAINTENANCE**

INSPECTION .....	10-20-1
VersaHANDLER Mounting Frame Inspection .....	10-20-1
Combination Bucket Mount Inspection .....	10-20-2
LUBRICATION .....	10-30-1
TROUBLESHOOTING .....	10-10-1

Dealer Copy -- Not for Resale

**TROUBLESHOOTING**

 <b style="font-size: 24pt; margin-left: 10px;">WARNING</b>	<p>Instructions are necessary before operating or servicing machine. Read and understand the Operation &amp; Maintenance Manual, Operator's Handbook and signs (decals) on machine. Follow warnings and instructions in the manuals when making repairs, adjustments or servicing. Check for correct function after adjustments, repairs or service. Untrained operators and failure to follow instructions can cause injury or death.</p> <p style="text-align: right; font-size: 10pt;">W-2003-0903</p>
--	---

If the Combination Bucket is not working correctly, check the hydraulic system of the VersaHANDLER thoroughly before making any repairs on the Combination Bucket. Combination Bucket problems can be affected by a hydraulic system that is not operating to specifications.

If the VersaHANDLER operation is found to be correct, use the following troubleshooting chart to locate and correct problems with the Combination Bucket.

PROBLEM	CAUSE	CORRECTION
Combination Bucket does not mount properly on the VersaHANDLER.	VersaHANDLER attachment locking pins are not fully retracted.	Retract VersaHANDLER attachment locking pins.
	Mud, dirt or stones are lodged between the VersaHANDLER mounting frame and the Combination Bucket mount.	Remove debris between the VersaHANDLER mounting frame and Combination Bucket mount.
Grapple does not open or close.	No hydraulic flow	Activate VersaHANDLER hydraulic on/off switch.
	No Hydraulic flow	Activate VersaHANDLER secondary auxiliary hydraulic switch.
	No hydraulic flow	Check quick couplers connection. Check for damaged hose ends and fittings.

Dealer Copy -- Not for Resale



## INSPECTION

### VersaHANDLER Mounting Frame Inspection

Figure 10-20-1

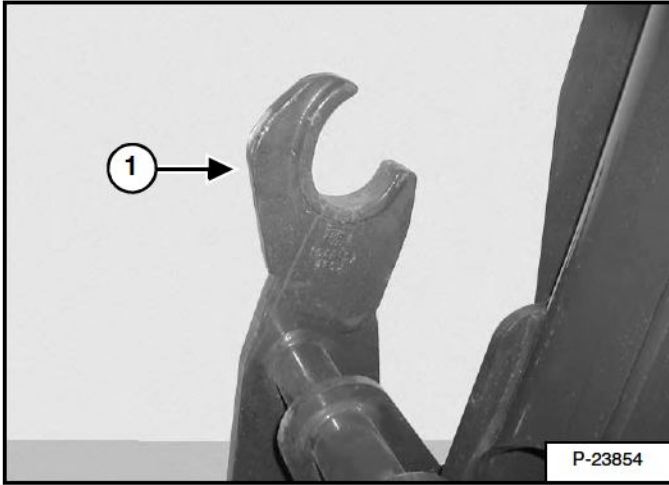

The VersaHANDLER mounting hooks (item 1) [Figure 10-20-1] must not be damaged. Check for cracked or broken hooks.

Figure 10-20-2

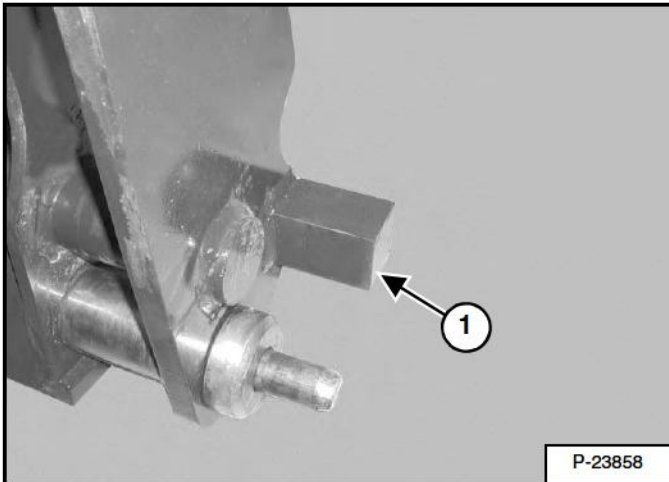

The stop blocks (Item 1) [Figure 10-20-2] must not be damaged. Check for bent or broken stop blocks.

Figure 10-20-3

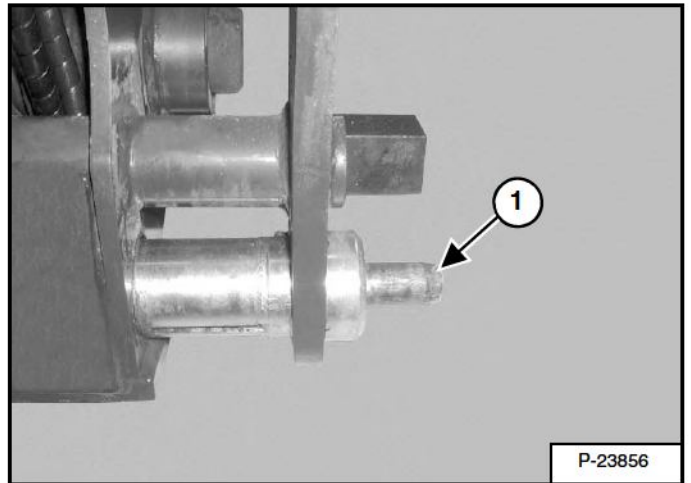

Move the VersaHANDLER locking pins to engage the pins (Item 1) [Figure 10-20-3]. The pins must move freely. The pins must not be bent or the ends mushroomed.

Figure 10-20-4

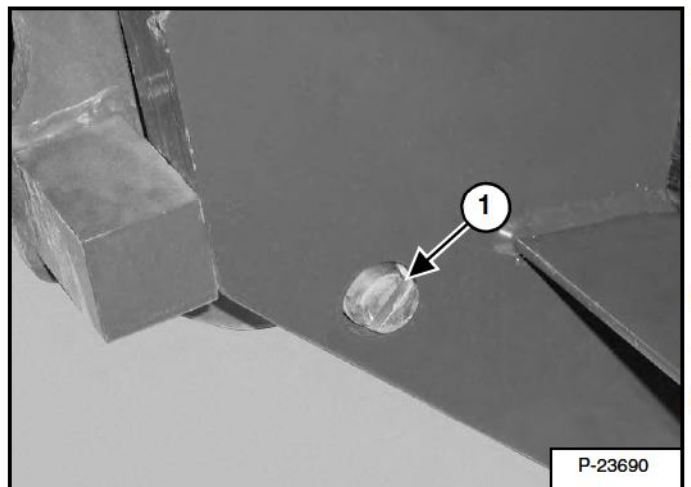

The pins must extend through the holes in the attachment mounting frame (Item 1) [Figure 10-20-4].

Dealer Copy -- Not for Resale

**Buy Now**



Our support email:

[ebooklibonline@outlook.com](mailto:ebooklibonline@outlook.com)