



---

# Service Manual

## T870 Compact Track Loader

---

S/N ASWT11001 & Above  
S/N B3BZ11001 & Above

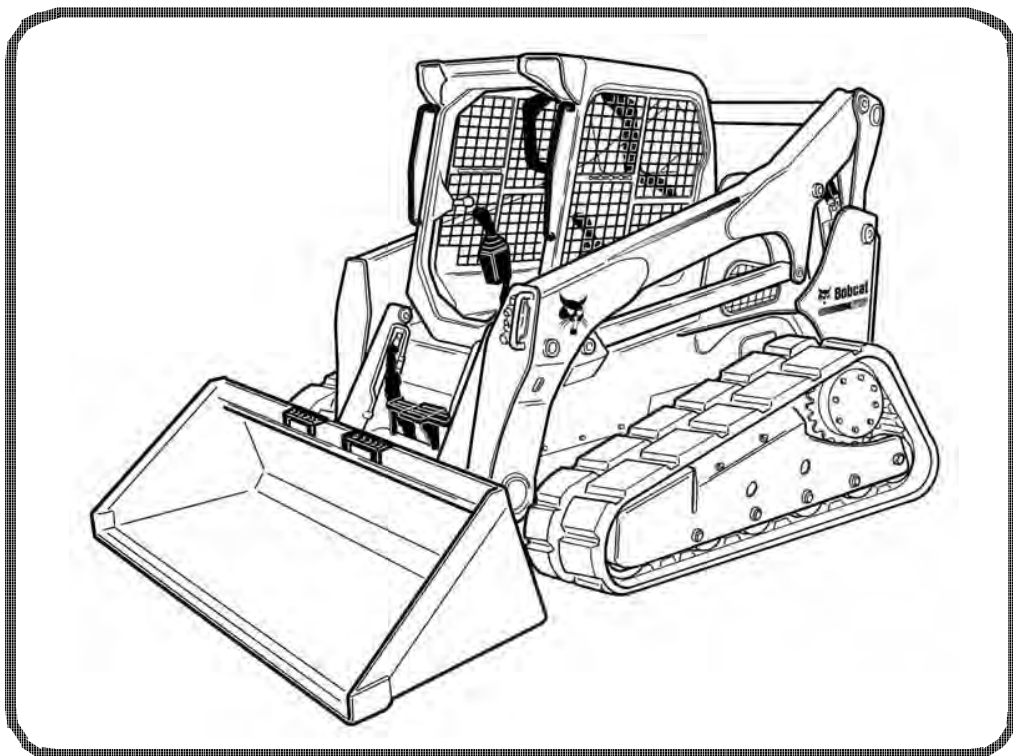

EQUIPPED WITH  
BOBCAT INTERLOCK  
CONTROL SYSTEM (BICS™)



# MAINTENANCE SAFETY



## WARNING

Instructions are necessary before operating or servicing machine. Read and understand the Operation & Maintenance Manual, Operator's Handbook and signs (decals) on machine. Follow warnings and instructions in the manuals when making repairs, adjustments or servicing. Check for correct function after adjustments, repairs or service. Untrained operators and failure to follow instructions can cause injury or death.

W-2003-0807



**Safety Alert Symbol:** This symbol with a warning statement, means: "Warning, be alert! Your safety is involved!" Carefully read the message that follows.

### CORRECT

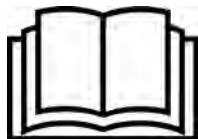

P-90216

- Never service the Bobcat Skid-Steer Loader without instructions.

### CORRECT

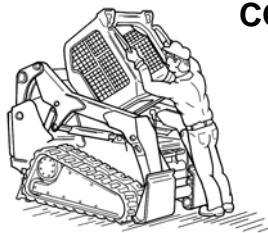

NA1711

- Use the correct procedure to lift or lower operator cab.

### CORRECT

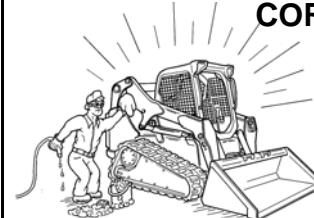

NA1715

- Cleaning and maintenance are required daily.

### WRONG



NA1714

- Have good ventilation when welding or grinding painted parts.
- Wear dust mask when grinding painted parts. Toxic dust and gas can be produced.
- Avoid exhaust fume leaks which can kill without warning. Exhaust system must be tightly sealed.

### WRONG

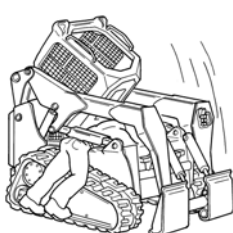

NA1710

- Disconnecting or loosening any hydraulic tubeline, hose, fitting, component or a part failure can cause lift arms to drop. Do not go under lift arms when raised unless supported by an approved lift arm support device. Replace it if damaged.

### WRONG

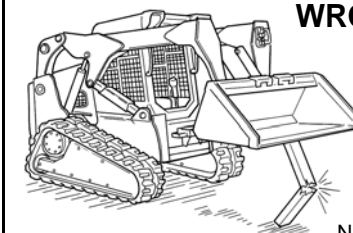

NA1712

- Never work on loader with lift arms up unless lift arms are held by an approved lift arm support device. Replace if damaged.
- Never modify equipment or add attachments not approved by Bobcat Company.

### WRONG



NA1722

- Stop, cool and clean engine of flammable materials before checking fluids.
- Never service or adjust loader with the engine running unless instructed to do so in the manual.
- Avoid contact with leaking hydraulic fluid or diesel fuel under pressure. It can penetrate the skin or eyes.
- Never fill fuel tank with engine running, while smoking or when near open flame.

### WRONG

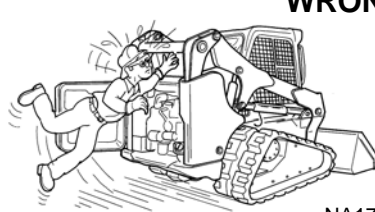

NA1725

- Keep body, jewelry and clothing away from moving parts, electrical contact, hot parts and exhaust.
- Wear eye protection to guard from battery acid, compressed springs, fluids under pressure and flying debris when engines are running or tools are used. Use eye protection approved for type of welding.
- Keep rear door closed except for service. Close and latch door before operating the loader.

### WRONG



B-6589

- Lead-acid batteries produce flammable and explosive gases.
- Keep arcs, sparks, flames and lighted tobacco away from batteries.
- Batteries contain acid which burns eyes or skin on contact.
- Wear protective clothing. If acid contacts body, flush well with water. For eye contact flush well and get immediate medical attention.

Maintenance procedures which are given in the Operation & Maintenance Manual can be performed by the owner/operator without any specific technical training. Maintenance procedures which are **not** in the Operation & Maintenance Manual must be performed **ONLY BY QUALIFIED BOBCAT SERVICE PERSONNEL**. Always use genuine Bobcat replacement parts. The Service Safety Training Course is available from your Bobcat dealer.

MSW40-0609

## CONTENTS

SAFETY AND MAINTENANCE .....	10-01
HYDRAULIC SYSTEM .....	20-01
HYDROSTATIC SYSTEM .....	30-01
DRIVE SYSTEM .....	40-01
MAINFRAME .....	50-01
ELECTRICAL SYSTEM AND ANALYSIS .....	60-01
ENGINE SERVICE .....	70-01
HEATING, VENTILATION AND AIR CONDITIONING (HVAC) .....	80-01
SPECIFICATIONS .....	SPEC-01
ALPHABETICAL INDEX .....	INDEX-01

## FOREWORD

FOREWORD .....	1-7
SAFETY INSTRUCTIONS .....	1-9
FIRE PREVENTION .....	1-11
Maintenance .....	1-11
Operation .....	1-11
Electrical .....	1-11
Hydraulic System .....	1-11
Fueling .....	1-11
Starting .....	1-11
Spark Arrester Exhaust System .....	1-11
Welding And Grinding .....	1-12
Fire Extinguishers .....	1-12
SERIAL NUMBER LOCATIONS .....	1-13
Loader Serial Number .....	1-13
Engine Serial Number .....	1-13
DELIVERY REPORT .....	1-14
LOADER IDENTIFICATION .....	1-15

# FOREWORD

This manual is for the Bobcat loader mechanic. It provides necessary servicing and adjustment procedures for the Bobcat loader and its component parts and systems. Refer to the Operation & Maintenance Manual for operating instructions, starting procedure, daily checks, etc.

A general inspection of the following items must be made after the loader has had service or repair:

1. Check that the ROPS/FOPS (Including side screens) is in good condition and is not modified.

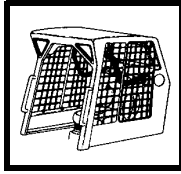

2. Check that ROPS mounting hardware is tightened and is Bobcat approved.

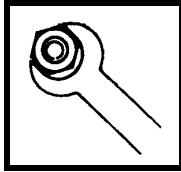

3. The seat belt must be correctly installed, functional and in good condition.

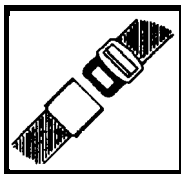

4. The seat bar must be correctly adjusted, clean and lubricated.

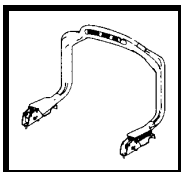

5. Check lift arm support device, replace if damaged.



6. Machine signs (decals) must be legible and in the correct location.



7. Steering levers, hand controls and foot pedals must return to neutral (as applicable).

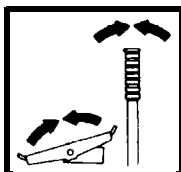

8. Check for correct function of the work lights.



9. The parking brake must function correctly.



10. Enclosure door latches must open and close freely.

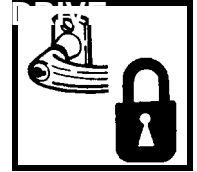

11. Bob-Tach® wedges and linkages must function correctly and be in good condition.

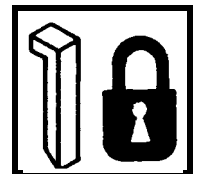

12. Safety treads must be in good condition.

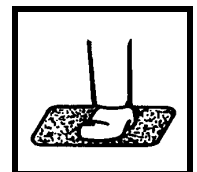

13. Check for correct function of indicator lamps.

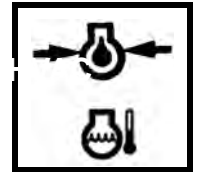

14. Check all machine fluid levels.

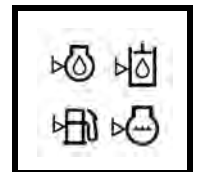

15. Inspect for fuel, oil or hydraulic fluid leaks.

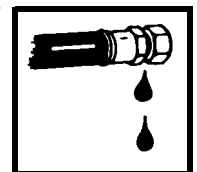

16. Lubricate the loader.



FW SSL-0617 SM

17. Check the condition of the battery and cables.

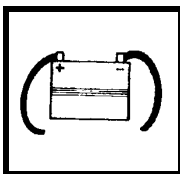

18. Inspect the air cleaner for damage or leaks. Check the condition of the element.

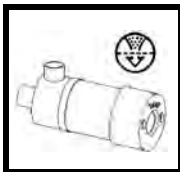

19. Check the electrical charging system.

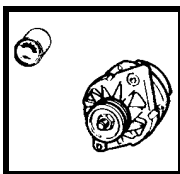

20. Check tires for wear and pressure. Check tracks for wear and tension. Use only approved tires or tracks.



21. Inspect for loose or broken parts or connections.



22. Check for any field modification not completed.



23. Operate the machine and check all functions.



24. Check for correct function of the Bobcat Interlock Control System (BICS™) before the machine is returned to the customer.



25. Check for proper function of front horn and back-up alarm (if equipped).

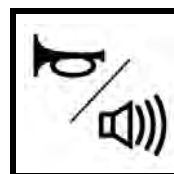

26. Check function or condition of all equipped options and accessories (examples: fire extinguisher, rotating beacon, lift kits, etc.).



27. Recommend to the owner that all necessary corrections be made before the machine is returned to service.

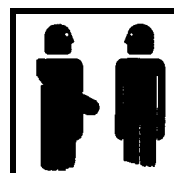

**CALIFORNIA  
PROPOSITION 65 WARNING**

Diesel engine exhaust and some of its constituents are known to the state of California to cause cancer, birth defects and other reproductive harm.

## SAFETY INSTRUCTIONS



### Safety Alert Symbol

This symbol with a warning statement means: "Warning, be alert! Your safety is involved!" Carefully read the message that follows.



## WARNING

### AVOID INJURY OR DEATH

Instructions are necessary before operating or servicing machine. Read and understand the Operation & Maintenance Manual, Operator's Handbook and signs (decals) on machine. Follow warnings and instructions in the manuals when making repairs, adjustments or servicing. Check for correct function after adjustments, repairs or service. Untrained operators and failure to follow instructions can cause injury or death.

W-2003-0807

## IMPORTANT

This notice identifies procedures which must be followed to avoid damage to the machine.

I-2019-0284



## DANGER

The signal word DANGER on the machine and in the manuals indicates a hazardous situation which, if not avoided, will result in death or serious injury.

D-1002-1107



## WARNING

The signal word WARNING on the machine and in the manuals indicates a potentially hazardous situation which, if not avoided, could result in death or serious injury.

W-2044-1107

The following publications provide information on the safe use and maintenance of the Bobcat machine and attachments:

- The Delivery Report is used to assure that complete instructions have been given to the new owner and that the machine is in safe operating condition.
- The Operation & Maintenance Manual delivered with the machine or attachment contains operating information as well as routine maintenance and service procedures. It is a part of the machine and can be stored in a container provided on the machine. Replacement Operation & Maintenance Manuals can be ordered from your Bobcat dealer.
- Machine signs (decals) instruct on the safe operation and care of your Bobcat machine or attachment. The signs and their locations are shown in the Operation & Maintenance Manual. Replacement signs are available from your Bobcat dealer.
- An Operator's Handbook fastened to the operator cab. It's brief instructions are convenient to the operator. The handbook is available from your dealer in an English edition or one of many other languages. See your Bobcat dealer for more information on translated versions.
- The AEM Safety Manual delivered with the machine gives general safety information.
- The Service Manual and Parts Manual are available from your dealer for use by mechanics to do shop-type service and repair work.
- The Skid-Steer Loader Operator Training Course is available through your local dealer or at [bobcat.com/training](http://bobcat.com/training) or [bobcat.com](http://bobcat.com). This course is intended to provide rules and practices of correct operation of the skid-steer loader. The course is available in English and Spanish versions.
- Service Safety Training Courses are available from your Bobcat dealer or at [bobcat.com/training](http://bobcat.com/training) or [bobcat.com](http://bobcat.com). They provide information for safe and correct service procedures.
- The Skid-Steer Loader Safety Video is available from your Bobcat dealer or at [bobcat.com/training](http://bobcat.com/training) or [bobcat.com](http://bobcat.com).

SI SSL-1016 SM

## FIRE PREVENTION



### Maintenance

The machine and some attachments have components that are at high temperatures under normal operating conditions. The primary source of high temperatures is the engine and exhaust system. The electrical system, if damaged or incorrectly maintained, can be a source of arcs or sparks.

Flammable debris (leaves, straw, etc.) must be removed regularly. If flammable debris is allowed to accumulate, it can cause a fire hazard. Clean often to avoid this accumulation. Flammable debris in the engine compartment is a potential fire hazard.

The operator's area, engine compartment and engine cooling system must be inspected every day and cleaned if necessary to prevent fire hazards and overheating.

All fuels, most lubricants and some coolants mixtures are flammable. Flammable fluids that are leaking or spilled onto hot surfaces or onto electrical components can cause a fire.

### Operation

Do not use the machine where exhaust, arcs, sparks or hot components can contact flammable material, explosive dust or gases.

### Electrical



Check all electrical wiring and connections for damage. Keep the battery terminals clean and tight. Repair or replace any damaged part or wires that are loose or frayed.

Battery gas can explode and cause serious injury. Use the procedure in the Operation & Maintenance Manual for connecting the battery and for jump starting. Do not jump start or charge a frozen or damaged battery. Keep any open flames or sparks away from batteries. Do not smoke in battery charging area.

## Hydraulic System

Check hydraulic tubes, hoses and fittings for damage and leakage. Never use open flame or bare skin to check for leaks. Hydraulic tubes and hoses must be properly routed and have adequate support and secure clamps. Tighten or replace any parts that show leakage.

Always clean fluid spills. Do not use gasoline or diesel fuel for cleaning parts. Use commercial nonflammable solvents.

### Fueling



Stop the engine and let it cool before adding fuel. No smoking! Do not refuel a machine near open flames or sparks. Fill the fuel tank outdoors.

Ultra Low Sulfur Diesel (ULSD) poses a greater static ignition hazard than earlier diesel formulations with higher Sulfur content. Avoid death or serious injury from fire or explosion. Consult with your fuel or fuel system supplier to ensure the delivery system is in compliance with fueling standards for proper grounding and bonding practices.

### Starting

Do not use ether or starting fluids on any engine that has glow plugs or air intake heater. These starting aids can cause explosion and injure you or bystanders.

Use the procedure in the Operation & Maintenance Manual for connecting the battery and for jump starting.

### Spark Arrester Exhaust System

The spark arrester exhaust system is designed to control the emission of hot particles from the engine and exhaust system, but the muffler and the exhaust gases are still hot.

Check the spark arrester exhaust system regularly to make sure it is maintained and working properly. Use the procedure in the Operation & Maintenance Manual for cleaning the spark arrester muffler (if equipped).



Thank you so much for reading.  
Please click the “Buy Now!”  
button below to download the  
complete manual.



After you pay.

You can download the most  
perfect and complete manual in  
the world immediately.

Our support email:

[ebooklibonline@outlook.com](mailto:ebooklibonline@outlook.com)