

**Toolcat™**  
**5600**



**Bobcat®**

# **Service Manual**

**S/N 520511001 & Above**

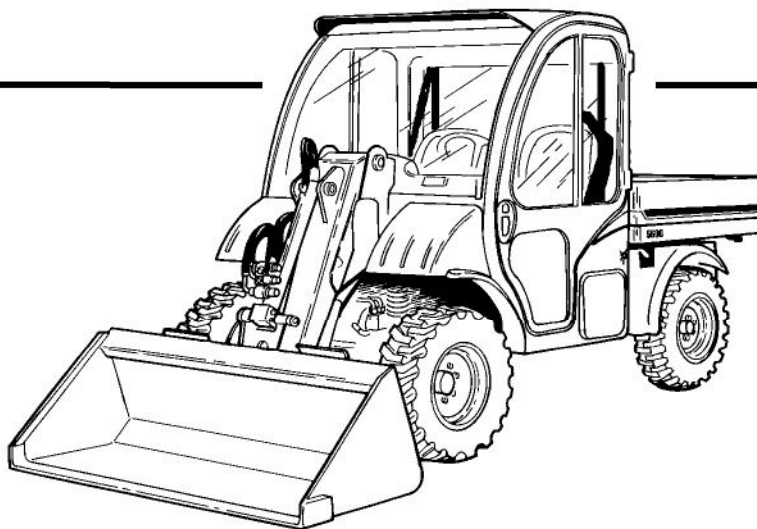

**Equipped With Toolcat Interlock  
Control System (TICS)**

6901892 (5-09)

Printed in U.S.A.

© Bobcat Company 2009

# MAINTENANCE SAFETY



## WARNING

Instructions are necessary before operating or servicing machine. Read and understand the Operation & Maintenance Manual, Operator's Handbook and signs (decals) on machine. Follow warnings and instructions in the manuals when making repairs, adjustments or servicing. Check for correct function after adjustments, repairs or service. Untrained operators and failure to follow instructions can cause injury or death. W-2003-0903



**Safety Alert Symbol:** This symbol with a warning statement, means: "Warning, be alert! Your safety is involved!" Carefully read the message that follows.

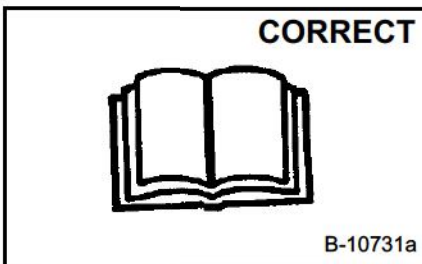

⚠ Never service the machine without instructions.

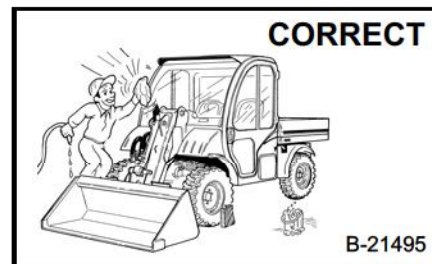

⚠ Cleaning and maintenance are required daily.

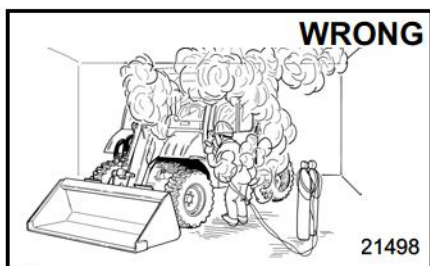

- ⚠ Have good ventilation when welding or grinding painted parts.
- ⚠ Wear dust mask when grinding painted parts. Toxic dust and gas can be produced.
- ⚠ Avoid exhaust fume leaks which can kill without warning. Exhaust system must be tightly sealed.

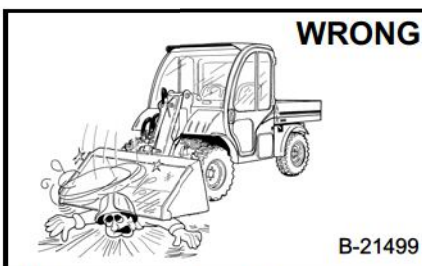

⚠ Disconnecting or loosening any hydraulic tubeline, hose, fitting, component or a part failure can cause lift arm or cargo box to drop. Do not go under lift arm or cargo box when raised unless supported by an approved lift arm or cargo box support device. Replace it if damaged.

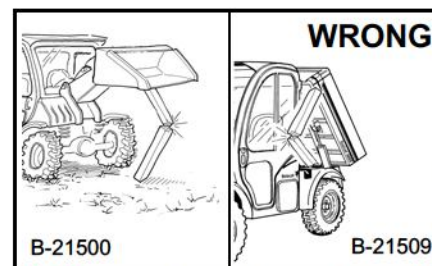

- ⚠ Never work on the machine with lift arm or cargo box up unless supported by an approved support device. Replace if damaged.
- ⚠ Never modify equipment or add attachments not approved by Bobcat Company.

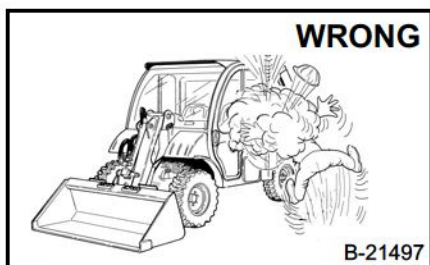

- ⚠ Stop, cool and clean engine of flammable materials before checking fluids.
- ⚠ Never service or adjust machine with the engine running unless instructed to do so in the manual.
- ⚠ Avoid contact with leaking hydraulic fluid or diesel fuel under pressure. It can penetrate the skin or eyes.
- ⚠ Never fill fuel tank with engine running, while smoking or when near open flame.

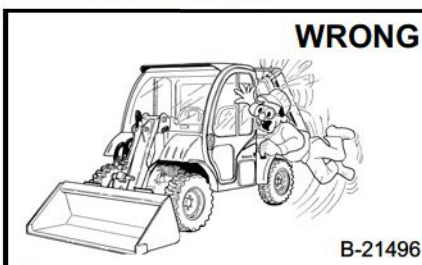

- ⚠ Keep body, jewelry and clothing away from moving parts, electrical contact, hot parts and exhaust.
- ⚠ Wear eye protection to guard from battery acid, compressed springs, fluids under pressure and flying debris when engines are running or tools are used. Use eye protection approved for type of welding.
- ⚠ Keep side access doors closed except for service.



- ⚠ Lead-acid batteries produce flammable and explosive gases.
- ⚠ Keep arcs, sparks, flames and lighted tobacco away from batteries.
- ⚠ Batteries contain acid which burns eyes or skin on contact. Wear protective clothing. If acid contacts body, flush well with water. For eye contact, flush well and get immediate medical attention.

Maintenance procedures which are given in the Operation & Maintenance Manual can be performed by the owner/operator without any specific technical training. Maintenance procedures which are **not** in the Operation & Maintenance Manual must be performed **ONLY BY QUALIFIED BOBCAT SERVICE PERSONNEL**. Always use genuine Bobcat replacement parts.

MSW25-0805



## ALPHABETICAL INDEX

AIR CLEANER .....	70-01	GENERAL AIR CONDITIONING SERVICE	
AIR CLEANER SERVICE .....	10-01	GUIDELINES .....	80-01
AIR CONDITIONING SERVICE .....	80-01	HEATER/AC FAN .....	80-01
AIR CONDITIONING SYSTEM FLOW .....	80-01	HEATER VALVE .....	80-01
ALTERNATOR .....	60-01	HITCH .....	50-01
ARM REST SENSOR .....	60-01	HYDRAULIC FLUID RESERVOIR .....	20-01
AUXILIARY HYDRAULIC VALVE .....	20-01	HYDRAULIC PUMP .....	20-01
AXLE .....	40-01	HYDRAULIC/HYDROSTATIC FILTER .....	20-01
AXLE/DIFFERENTIAL (FRONT & REAR) .....	10-01	HYDRAULIC/HYDROSTATIC	
AXLE HUB WITH AXLE SHAFT .....	40-01	FLUID SPECIFICATIONS .....	SPEC-01
AXLE HUB WITHOUT AXLE SHAFT .....	40-01	HYDRAULIC/HYDROSTATIC SYSTEM .....	10-01
AXLE SHAFT .....	40-01	HYDRAULIC SYSTEM INFORMATION .....	20-01
		HYDROSTATIC MOTOR .....	30-01
BATTERY .....	60-01	HYDROSTATIC PUMP .....	30-01
BOB-TACH .....	10-01, 50-01	HYDROSTATIC SYSTEM INFORMATION .....	30-01
BRAKE .....	40-01		
		INSTRUMENT PANEL .....	60-01
CALIBRATION .....	60-01	LEAF SPRING .....	50-01
CARGO BOX .....	50-01	LIFT ARM .....	50-01
CARGO BOX SUPPORT DEVICE .....	10-01	LIFT ARM BY-PASS CONTROL VALVE .....	20-01
CENTER CONSOLE .....	50-01	LIFT ARM SUPPORT DEVICE .....	10-01
CHARGE PRESSURE .....	30-01	LIFTING AND BLOCKING THE LOADER .....	10-01
COMPONENTS .....	80-01	LIGHTS .....	60-01
COMPRESSOR .....	80-01	LUBRICATION .....	10-01
CODENSER .....	80-01		
CONTROL LEVER (JOYSTICK) .....	20-01	MAIN RELIEF VALVE .....	20-01
CONVERSIONS .....	SPEC-01	MUFFLER .....	70-01
COOLING FAN .....	70-01		
CYLINDER (CARGO BOX) .....	20-01	OIL COOLER .....	30-01
CYLINDER (LIFT) .....	20-01	OPERATOR CAB .....	10-01, 50-01
CYLINDER (TILT) .....	20-01	OPERATOR SEAT .....	50-01
DIAGNOSTICS .....	60-01	PARKING BRAKE .....	40-01
DISPLAY CONTROLLER .....	60-01	PASSENGER SEAT .....	50-01
DRIVE BELT .....	30-01	PILOT VALVE .....	20-01
DRIVE CONTROLLER .....	60-01	PORT BLOCK .....	30-01
		PORT RELIEF .....	20-01
ELECTRICAL SYSTEM INFORMATION .....	60-01	POWER STEERING PUMP .....	20-01
ENGINE .....	70-01		
ENGINE COMPONENTS AND TESTING .....	70-01	RPM SENSOR .....	70-01
ENGINE COOLING SYSTEM .....	10-01	RADIATOR .....	70-01
ENGINE LUBRICATION SYSTEM .....	10-01	RECEIVER/DRIER .....	80-01
ENGINE SPECIFICATIONS .....	SPEC-01	RECONDITIONING THE ENGINE .....	70-01
ENGINE SPEED CONTROL .....	70-01	REGULAR MAINTENANCE .....	80-01
EVAPORATOR/HEATER UNIT .....	80-01	REMOTE START .....	10-01
EXPANSION VALVE .....	80-01	REMOTE HYDRAULICS DIVERTER VALVE .....	20-01
FENDER (FRONT LEFT) .....	50-01		
FENDER (FRONT RIGHT) .....	50-01		
FENDER (REAR LEFT) .....	50-01		
FENDER (REAR RIGHT) .....	50-01		
FLOOR CONSOLE .....	50-01		
FLYWHEEL AND HOUSING .....	70-01		
FRONT AUXILIARY HYD. COUPLER BLOCK .....	20-01		
FUEL SYSTEM .....	10-01		
FUEL TANK .....	50-01		

**Continued On Next Page**

Dealer Copy -- Not for Resale

## ALPHABETICAL INDEX (CONT'D)

SAFETY .....	80-01
SERVICE PC (LAPTOP COMPUTER) .....	60-01
SERVICE SCHEDULE .....	10-01
SHOCKS.....	50-01
SPARK ARRESTOR MUFFLER .....	10-01
STARTER .....	60-01
STEERING AND CARGO BOX VALVE .....	20-01
STEERING COLUMN .....	50-01
SYSTEM CHARGING AND RECLAMATION .....	80-01
SYSTEM TROUBLESHOOTING.....	80-01
TEMPERATURE/PRESSURE .....	80-01
THERMOSTAT .....	80-01
TICS SYSTEM.....	60-01
TIE ROD .....	40-01
TIRE MAINTENANCE .....	10-01
TORQUE SPECIFICATIONS FOR BOLTS ....	SPEC-01
TOWING THE MACHINE .....	10-01
TRAILING ARMS.....	50-01
TRANSPORTING THE TOOLCAT .....	10-01
TRAVEL AND BRAKE PEDALS .....	50-01
TRAVEL DIRECTION CONTROL LEVER.....	60-01
TROUBLESHOOTING.....	70-01
UTILITY WORK MACHINE SPECIFICATIONS .	SPEC-01
WHEEL POSITION SENSOR.....	60-01
WHEEL SPEED SENSOR.....	60-01
WORK VALVE.....	20-01



# CONTENTS

FOREWORD.....	II
SAFETY INSTRUCTIONS .....	V
FIRE PREVENTION .....	VII
SERIAL NUMBER LOCATIONS .....	IX
DELIVERY REPORT.....	IX
BOBCAT UTILITY WORK MACHINE IDENTIFICATION .....	X
SAFETY AND MAINTENANCE.....	10-01
HYDRAULIC SYSTEM .....	20-01
HYDROSTATIC SYSTEM.....	30-01
DRIVE SYSTEM .....	40-01
MAIN FRAME .....	50-01
ELECTRICAL SYSTEM & ANALYSIS.....	60-01
ENGINE SERVICE .....	70-01
HEATING, VENTILATION, AIR CONDITIONING .....	80-01
SPECIFICATIONS.....	SPEC-01

**SAFETY &  
MAINTENANCE**

**HYDRAULIC  
SYSTEM**

**HYDROSTATIC  
SYSTEM**

**DRIVE  
SYSTEM**

**MAIN FRAME**

**ELECTRICAL  
SYSTEM &  
ANALYSIS**

**ENGINE  
SERVICE**

**HVAC**

**SPECIFICATIONS**

# FOREWORD

This manual is for the Toolcat Utility Work Machine mechanic. It provides necessary servicing and adjustment procedures for the Toolcat Utility Work Machine and its component parts and systems. Refer to the for operating instructions, starting procedure, daily checks, etc.

A general inspection of the following items must be made after the loader has had service or repair:

1. Check that the ROPS/FOPS (Including front and rear window) is in good condition and is not modified.



10. The parking brake must function correctly.



2. Check that ROPS mounting hardware is tightened and is Bobcat approved.



11. Enclosure door latches must open and close freely.



3. The operator and passenger seat belts must be correctly installed, functional and in good condition.



12. Bob-Tach wedges and linkages must function correctly and be in good condition.

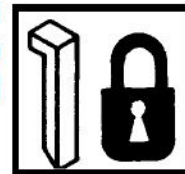

5. Check lift arm support device, replace if damaged.



13. Safety treads and floor mats must be in good condition.

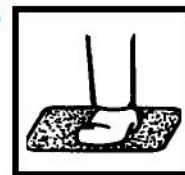

6. Check cargo box support device, replace if damaged.



14. Check for correct function of indicator lamps.

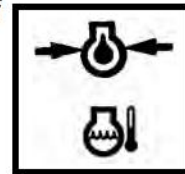

7. Machine signs (decals) must be legible and in the correct location.



15. Check hydraulic fluid level, engine oil level and fuel supply.



8. Joystick control lever and foot pedals must return to neutral.

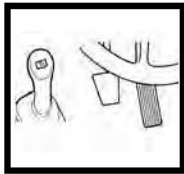

16. Inspect for fuel, oil or hydraulic fluid leaks.

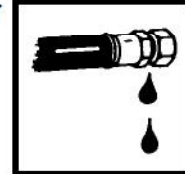

9. Check for correct function of the work lights.



17. Lubricate the machine.



FW TC-0308 SM

Dealer Copy -- Not for Resale

18. Check the condition of the battery and cables.

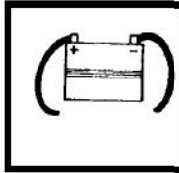

23. Check for any field modification not completed.



19. Inspect the air cleaner for damage or leaks. Check the condition of the element.

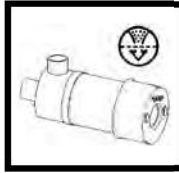

23. Operate the machine and check all functions.

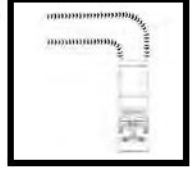

20. Check the electrical charging system.

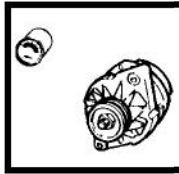

25. Check for correct function of the Toolcat Interlock Control System (TICS) before the machine is returned to the customer.



21. Check tires for wear and pressure. Use only approved tires.



26. Check function or condition of all equipped options and accessories (examples: back-up alarm, fire extinguisher, rotating beacon, etc.).



22. Inspect for loose or broken parts or connections.

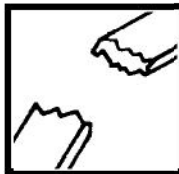

27. Recommend to the owner that all necessary corrections be made before the machine is returned to service.

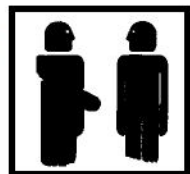

Dealer Copy -- Not for Resale

**CALIFORNIA  
PROPOSITION 65 WARNING**

Diesel engine exhaust and some of its constituents are known to the state of California to cause cancer, birth defects and other reproductive harm.



## FIRE PREVENTION



### Maintenance

The machine and some attachments have components that are at high temperatures under normal operating conditions. The primary source of high temperatures is the engine and exhaust system. The electrical system, if damaged or incorrectly maintained, can be a source of arcs or sparks.

Flammable debris (leaves, straw, etc.) must be removed regularly. If flammable debris is allowed to accumulate, it can cause a fire hazard. Clean often to avoid this accumulation. Flammable debris in the engine compartment is a potential fire hazard.

The operator's area, engine compartment and engine cooling system must be inspected every day and cleaned if necessary to prevent fire hazards and overheating.

All fuels, most lubricants and some coolants mixtures are flammable. Flammable fluids that are leaking or spilled onto hot surfaces or onto electrical components can cause a fire.

### Operation

Do not use the machine where exhaust, arcs, sparks or hot components can contact flammable material, explosive dust or gases.

### Electrical



Check all electrical wiring and connections for damage. Keep the battery terminals clean and tight. Repair or replace any damaged part or wires that are loose or frayed.

Battery gas can explode and cause serious injury. Use the procedure in the Operation & Maintenance Manual for connecting the battery and for jump starting. Do not jump start or charge a frozen or damaged battery. Keep any open flames or sparks away from batteries. Do not smoke in battery charging area.

## Hydraulic System

Check hydraulic tubes, hoses and fittings for damage and leakage. Never use open flame or bare skin to check for leaks. Hydraulic tubes and hoses must be properly routed and have adequate support and secure clamps. Tighten or replace any parts that show leakage.

Always clean fluid spills. Do not use gasoline or diesel fuel for cleaning parts. Use commercial nonflammable solvents.

### Fueling



Stop the engine and let it cool before adding fuel. No smoking! Do not refuel a machine near open flames or sparks. Fill the fuel tank outdoors.

### Starting

Do not use ether or starting fluids on any engine that has glow plugs. These starting aids can cause explosion and injure you or bystanders.

Use the procedure in the Operation & Maintenance Manual for connecting the battery and for jump starting.

## Spark Arrestor Exhaust System

The spark arrestor exhaust system is designed to control the emission of hot particles from the engine and exhaust system, but the muffler and the exhaust gases are still hot.

Check the spark arrestor exhaust system regularly to make sure it is maintained and working properly. Use the procedure in the Operation & Maintenance Manual for cleaning the spark arrestor muffler (if equipped).

Dealer Copy - Not for Resale



## FIRE PREVENTION (CONT'D)

### Welding And Grinding

Always clean the machine and attachment, disconnect the battery, and disconnect the wiring from the Bobcat controllers before welding. Cover rubber hoses, battery and all other flammable parts. Keep a fire extinguisher near the machine when welding.

Have good ventilation when grinding or welding painted parts. Wear dust mask when grinding painted parts. Toxic dust or gas can be produced.

Dust generated from repairing nonmetallic parts such as hoods, fenders or covers can be flammable or explosive. Repair such components in a well ventilated area away from open flames or sparks.

### Fire Extinguishers

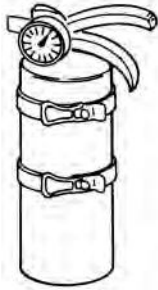

Know where fire extinguishers and first aid kits are located and how to use them. Inspect the fire extinguisher and service the fire extinguisher regularly. Obey the recommendations on the instructions plate.

## SERIAL NUMBER LOCATIONS

Always use the serial number of the machine when requesting service information or when ordering parts. Early or later models (identification made by serial number) may use different parts, or it may be necessary to use a different procedure in doing a specific service operation.

### Work Machine Serial Number

Figure 1



The Toolcat Utility Work Machine serial number plate is located on the rear of the frame below the Cargo Box [Figure 1].

Explanation of machine Serial Number:

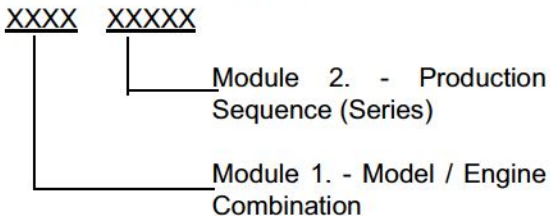

1. The four digit Model/Engine Combination Module number identifies the model number and engine combination.

2. The five digit Production Sequence Number identifies the order which the machine is produced.

### Engine Serial Number

Figure 1-1-1

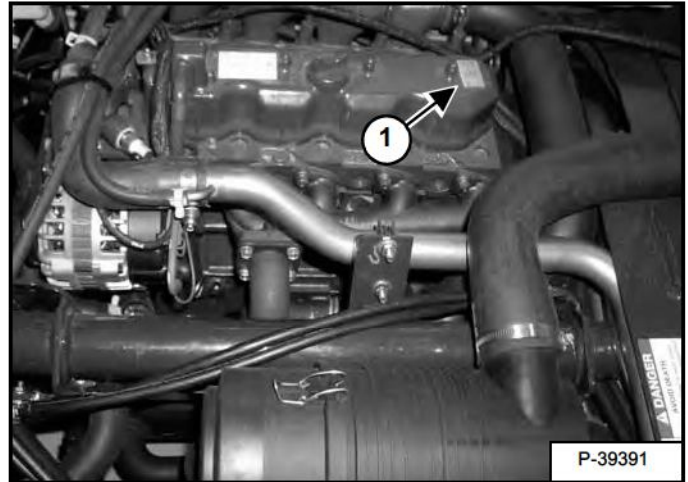

### DELIVERY REPORT

The engine serial number is located at the right end of the valve cover (Item 1) [Figure 1-1-1].

Figure 1-1-2

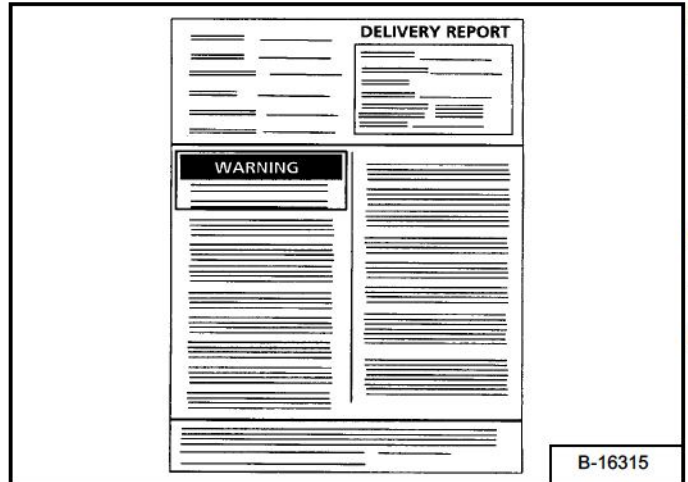

The delivery report must be filled out by the dealer and signed by the owner or operator when the Toolcat Utility Work Machine is delivered. An explanation of the form must be given to the owner. Make sure it is filled out completely [Figure 1-1-2].

Dealer Copy -- Not for Resale



**BOBCAT UTILITY WORK MACHINE IDENTIFICATION**

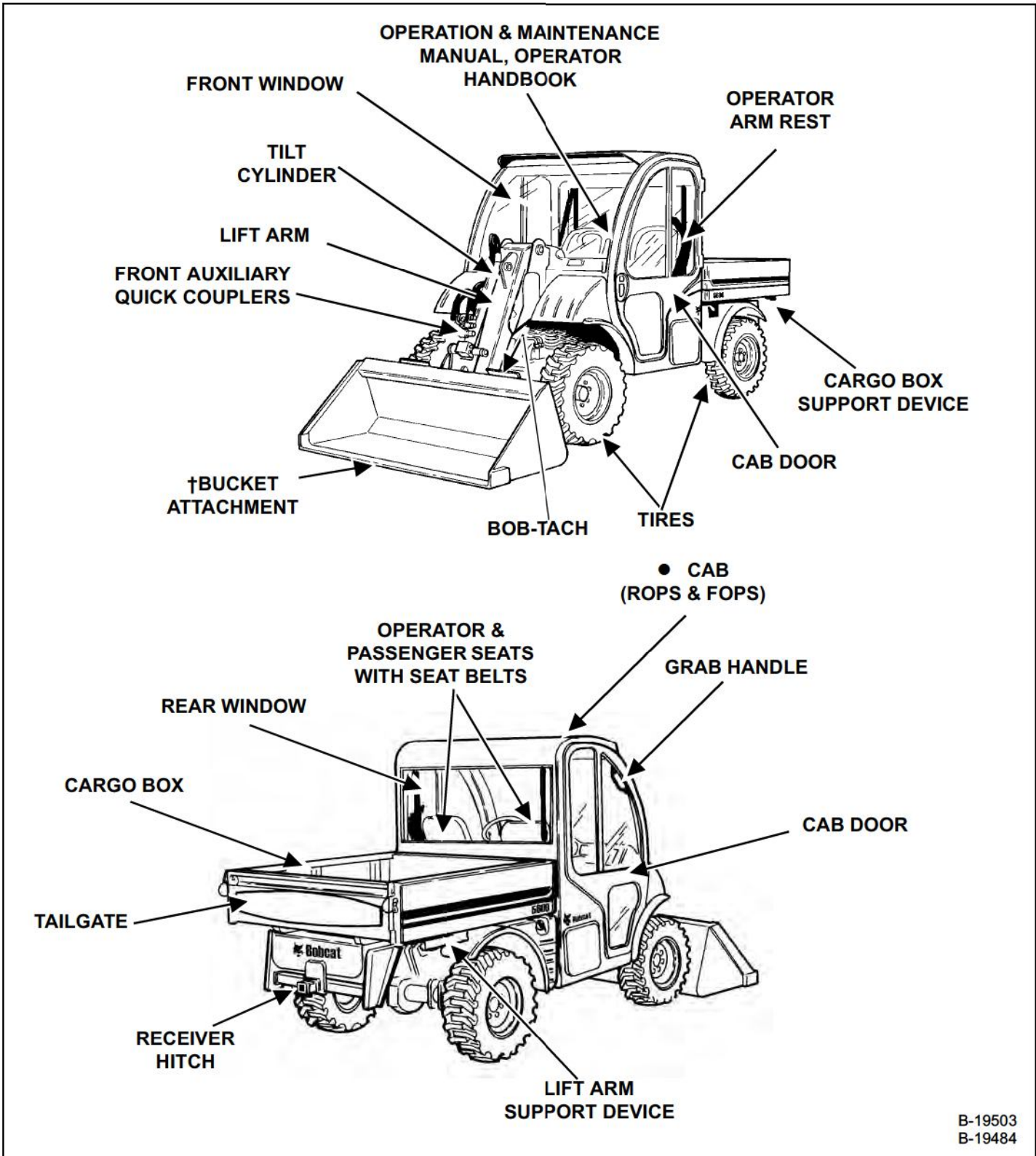

† BUCKET - Several different buckets and other attachments are available for the Toolcat Utility Work Machine.  
 ● ROPS, FOPS - Roll Over Protective Structure, per SAE J1040 and ISO 3471, and Falling Object Protective Structure per SAEJ1043 and ISO 3449, Level I.

Dealer Copy -- Not for Resale

B-19503  
B-19484

**SAFETY AND MAINTENANCE**

AIR CLEANER SERVICE . . . . . 10-80-1  
 Replacing Filter Elements . . . . . 10-80-1

AXLE/DIFFERENTIAL (FRONT & REAR) . . . . . 10-130-1  
 Checking And Adding Lubricant. . . . . 10-130-1  
 Replacing Lubricant. . . . . 10-130-1

BOB-TACH . . . . . 10-140-1  
 Inspection And Maintenance . . . . . 10-140-1

CARGO BOX SUPPORT DEVICE . . . . . 10-21-1  
 Installing The Cargo Box Support Device . . . . . 10-21-1  
 Removing the Cargo Box Support Device . . . . . 10-21-1

ENGINE COOLING SYSTEM . . . . . 10-90-1  
 Cleaning The Cooling System . . . . . 10-90-1  
 Checking The Coolant Level . . . . . 10-90-1  
 Removing & Replacing Coolant. . . . . 10-90-2

ENGINE LUBRICATION SYSTEM . . . . . 10-110-1  
 Checking Engine Oil . . . . . 10-110-1  
 Oil Chart. . . . . 10-110-1  
 Replacing The Oil And Filter . . . . . 10-110-2

FUEL SYSTEM . . . . . 10-100-1  
 Filling The Fuel Tank . . . . . 10-100-1  
 Fuel Filter. . . . . 10-100-1  
 Fuel Specifications. . . . . 10-100-1  
 Removing Air From The Fuel System . . . . . 10-100-2

HYDRAULIC / HYDROSTATIC SYSTEM . . . . . 10-120-1  
 Checking And Adding Fluid . . . . . 10-120-1  
 Hydraulic Fluid Chart . . . . . 10-120-2  
 Replacing Hydraulic Fluid . . . . . 10-120-2  
 Replacing Hydraulic/Hydrostatic Filter. . . . . 10-120-1  
 Reservoir Breather. . . . . 10-120-2

LIFT ARM SUPPORT DEVICE . . . . . 10-20-1  
 Installing The Lift Arm Support Device. . . . . 10-20-1  
 Removing the Lift Arm Support Device . . . . . 10-20-1

LIFTING AND BLOCKING THE MACHINE. . . . . 10-10-1  
 Procedure For Jackstand Placement On The Axle . . . . . 10-10-1  
 Procedure For Jackstand Placement On The Frame . . . . . 10-10-2

LUBRICATION . . . . . 10-150-1  
 Lubrication Locations. . . . . 10-150-1

**Continued On Next Page**

Dealer Copy -- Not for Resale



## SAFETY AND MAINTENANCE (CONT'D)

OPERATOR CAB .....	10-30-1
Description .....	10-30-1
REMOTE START .....	10-60-1
Procedure .....	10-60-1
SERVICE SCHEDULE .....	10-70-1
Chart .....	10-70-1
SPARK ARRESTOR MUFFLER .....	10-170-1
Maintenance .....	10-170-1
TIRE MAINTENANCE .....	10-160-1
Mounting .....	10-160-1
Tire Rotation .....	10-160-1
Wheel Nuts .....	10-160-1
TOWING THE MACHINE .....	10-50-1
Procedure .....	10-50-1
TRANSPORTING THE TOOLCAT .....	10-40-1
Fastening To Transport Vehicle .....	10-40-1
Loading Onto Transport Vehicle .....	10-40-1

**TIGHTEN ALL HARDWARE PER SIZE TO GRADE 5 TORQUE (SEE STANDARD TORQUE SPECIFICATIONS FOR BOLTS, SPEC SECTION) UNLESS OTHERWISE SPECIFIED.**

**SPECIFICATIONS SUBJECT TO CHANGE WITHOUT NOTICE AND STANDARD ITEMS MAY VARY.**

## LIFTING AND BLOCKING THE MACHINE

### Procedure For Jackstand Placement On The Axle

**NOTE:** For jackstand placement procedure used for axle removals and other axle related component procedures (See Procedure For Jackstand Placement On The Frame on Page 10-10-2.)

	<b>⚠ DANGER</b>
	<b>AVOID DEATH</b> <ul style="list-style-type: none"><li>• Never reach under or stand under raised lift arm unless supported by an approved lift arm support.</li><li>• Moving a lift arm control or failure of a part can cause lift arm to drop.</li></ul>

<b>⚠ WARNING</b>
------------------

#### AVOID INJURY OR DEATH

Instructions are necessary before operating or servicing machine. Read and understand the Operation & Maintenance Manual, Operator's Handbook and signs (decals) on machine. Follow warnings and instructions in the manuals when making repairs, adjustments or servicing. Check for correct function after adjustments, repairs or service. Untrained operators and failure to follow instructions can cause injury or death.

W-2003-0807

Always park the machine on a level surface.

Install the approved lift arm support device. (See Installing The Lift Arm Support Device on Page 10-20-1.)

Figure 10-10-1

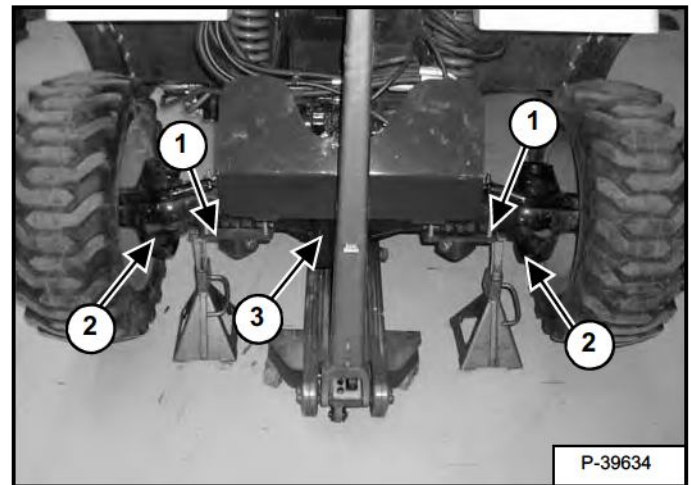

Place the jackstands on the front axle between the axle mounts (Item 1) and the axle hub (Item 2) [Figure 10-10-1].

**NOTE:** When lifting the machine place the jack under the frame. Do not lift from the axle differential housing (Item 3) [Figure 10-10-1] this can cause the machine to tilt due to the suspension and the offset axle differential housing.

Figure 10-10-2

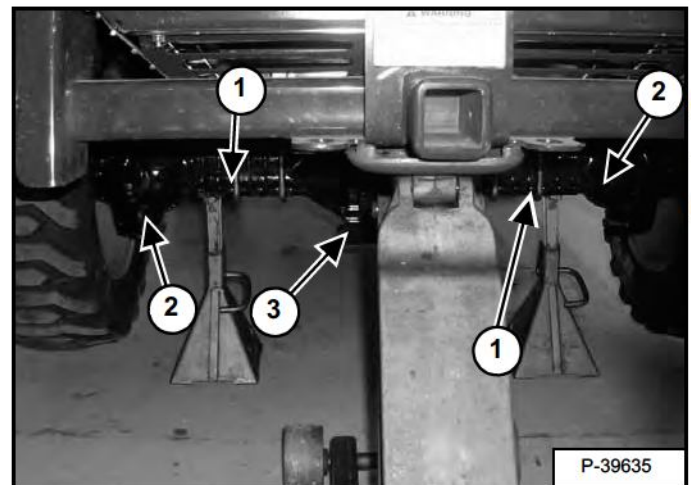

Place the jackstands on the rear axle between the axle mounts (Item 1) and the axle hub (Item 2) [Figure 10-10-2].

**NOTE:** When lifting the machine place the jack under the rear hitch. Do not lift from the axle differential housing (Item 3) [Figure 10-10-2] this can cause the machine to tilt due to the suspension and the offset axle differential housing.

Dealer Copy -- Not for Resale



Thank you so much for reading.  
Please click the “Buy Now!”  
button below to download the  
complete manual.



After you pay.

You can download the most  
perfect and complete manual in  
the world immediately.

Our support email:

[ebooklibonline@outlook.com](mailto:ebooklibonline@outlook.com)