



# Bobcat®

---

## Service Manual V417 VersaHANDLER®

---

S/N AC1C11001 & Above (with Cab)  
S/N AC1D11001 & Above (with Canopy)

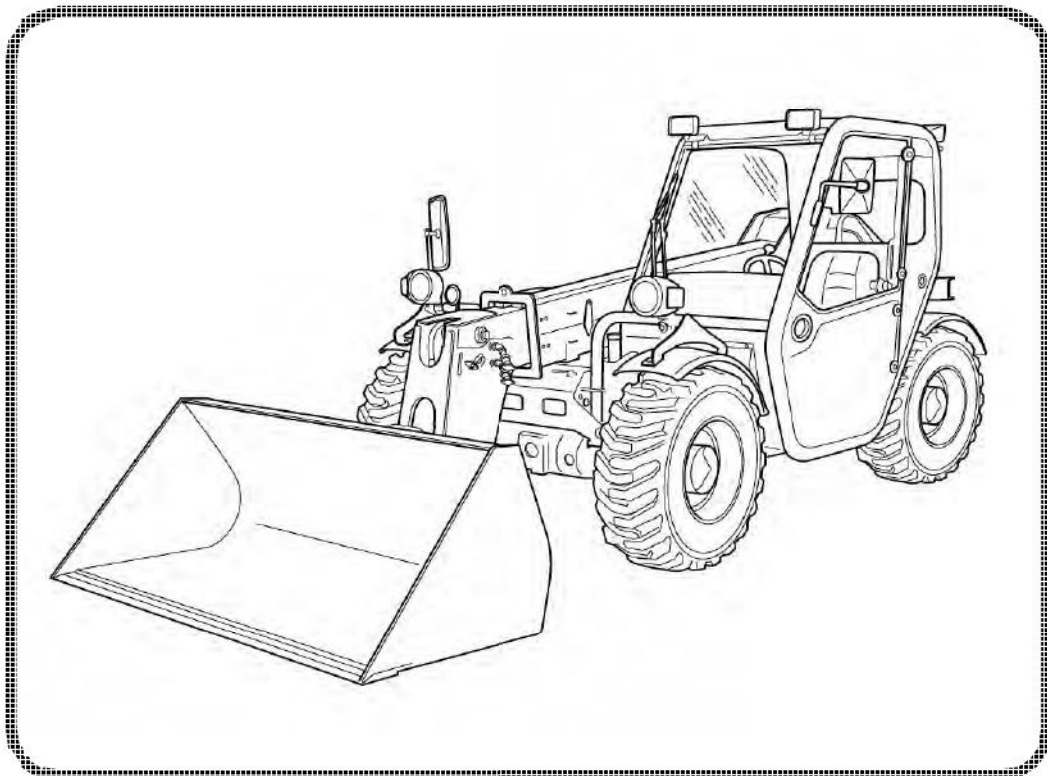

Dealer Copy -- Not for Resale



# MAINTENANCE SAFETY



## WARNING

Instructions are necessary before operating or servicing machine. Read and understand the Operation & Maintenance Manual, Operator's Handbook and signs (decals) on machine. Follow warnings and instructions in the manuals when making repairs, adjustments or servicing. Check for correct function after adjustments, repairs or service. Untrained operators and failure to follow instructions can cause injury or death.

W-2003-0807

### CORRECT

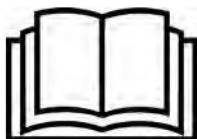

P-90216

⚠ Never service the Bobcat VersaHANDLER without instructions.



**Safety Alert Symbol:** This symbol with a warning statement, means: "Warning, be alert! Your safety is involved!" Carefully read the message that follows.

### CORRECT

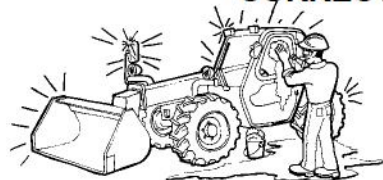

B-16082

⚠ Cleaning and maintenance are required daily.

### WRONG

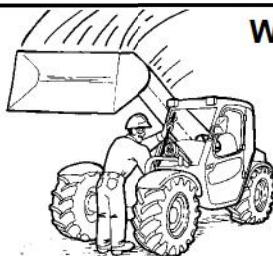

B-16080

⚠ Disconnecting or loosening any hydraulic tubeline, hose, fitting, component or a part failure can cause boom to drop. Do not go under boom when raised unless supported by an approved boom stop. Replace if damaged.

### WRONG

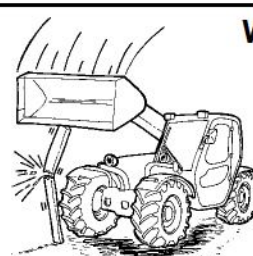

B-16079

⚠ Never work on VersaHANDLER with boom up unless boom is held by an approved boom stop. Replace if damaged.  
⚠ Never modify equipment or add attachments not approved by Bobcat Company.

### WRONG

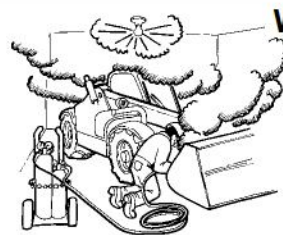

B-16081

⚠ Have good ventilation when welding or grinding painted parts.  
⚠ Wear dust mask when grinding painted parts. Toxic dust and gas can be produced.  
⚠ Avoid exhaust fume leaks which can kill without warning. Exhaust system must be tightly sealed.

### WRONG



B-16078

⚠ Keep body, jewelry and clothing away from moving parts, electrical contact, hot parts and exhaust.  
⚠ Wear eye protection to guard from battery acid, compressed springs, fluids under pressure and flying debris when engines are running or tools are used. Use eye protection approved for type of welding.

### WRONG



B-6589

⚠ Lead-acid batteries produce flammable and explosive gases.  
⚠ Keep arcs, sparks, flames and lighted tobacco away from batteries.  
⚠ Batteries contain acid which burns eyes or skin on contact. Wear protective clothing. If acid contacts body, flush well with water. For eye contact flush well and get immediate medical attention.

Dealer Copy -- Not for Resale

Maintenance procedures which are given in the Operation & Maintenance Manual can be performed by the owner/operator without any specific technical training. Maintenance procedures which are not in the Operation & Maintenance Manual must be performed **ONLY BY QUALIFIED BOBCAT SERVICE PERSONNEL**. Always use genuine Bobcat replacement parts.

MSW12-0409

## CONTENTS

SAFETY & MAINTENANCE .....	10-01
HYDRAULIC SYSTEM .....	20-01
HYDROSTATIC SYSTEM .....	30-01
DRIVE SYSTEM .....	40-01
MAINFRAME .....	50-01
ELECTRICAL SYSTEM & ANALYSIS .....	60-01
ENGINE SERVICE .....	70-01
HEATING, VENTILATION AND AIR CONDITIONING (HVAC) .....	80-01
SPECIFICATIONS .....	SPEC-01
ALPHABETICAL INDEX .....	INDEX-01

Dealer Copy -- Not for Resale

## FOREWORD













FOREWORD .....	1-7
SAFETY INSTRUCTIONS .....	1-9
FIRE PREVENTION .....	1-10
Maintenance .....	1-10
Operation .....	1-10
Electrical .....	1-10
Hydraulic System .....	1-11
Fueling .....	1-11
Starting .....	1-11
Spark Arrestor Exhaust System .....	1-11
Welding And Grinding .....	1-11
Fire Extinguishers .....	1-11
SERIAL NUMBER LOCATION .....	1-12
VersaHANDLER Serial Number .....	1-12
Engine Serial Number .....	1-12
Other Serial Numbers .....	1-12
DELIVERY REPORT .....	1-13
BOBCAT VERSAHANDLER IDENTIFICATION .....	1-14

Dealer Copy -- Not for Resale

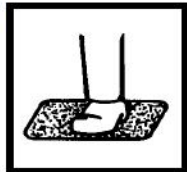
# FOREWORD

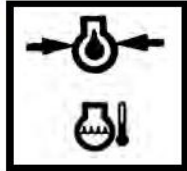
This manual is for the Bobcat VersaHANDLER mechanic. It provides necessary servicing and adjustment procedures for the Bobcat VersaHANDLER and its component parts and systems. Refer to the Operation & Maintenance Manual for operating instructions, starting procedure, daily checks, etc.

A general inspection of the following items must be made after the VersaHANDLER has had service or repair:

- |   |   |  |   |
|---|---|--|---|
| 1. Check that ROPS/FOPS (including right side window) is in good condition and is not modified. |    | 8. The parking brake must function correctly.  |    |
| 2. Check that ROPS mounting hardware is tightened and is Bobcat approved.                       |    | 9. Enclosure door latches must open and close freely.  |    |
| 3. The seat belt must be correctly installed, functional and in good condition.                 |    | 10. Attachment locking pins must function correctly and be in good condition. Bob-Tach wedges and linkages (if equipped) must function correctly and be in good condition. |    |
| 4. Check boom stop, replace if damaged.   |  | 11. Safety treads must be in good condition.   |  |
| 5. Machine signs (decals) must be legible and in the correct location.                          |  | 12. Check for correct function of indicator lamps and gauges.  |  |
| 6. Joystick control lever and foot pedals must return to neutral.                               |  | 13. Check hydraulic fluid level, engine oil level and fuel supply.   |  |
| 7. Check for correct function of the work lights.   |  | 14. Inspect for fuel, oil or hydraulic fluid leaks.  |  |

Dealer Copy -- Not for Resale

15. Lubricate the VersaHANDLER.



20. Check for any field modification not completed.



16. Check the condition of the battery and cables.

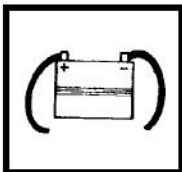

20. Operate the machine and check all functions.

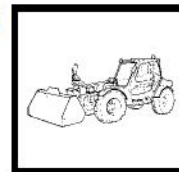

17. Inspect the air cleaner for damage or leaks. Check the condition of the element.



21. Check for correct function of the Lateral Operator Restraint System (LORS) if equipped.



18. Check the electrical charging system.

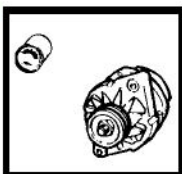

22. Check function or condition of all equipped options and accessories (examples: back-up alarm, fire extinguisher, rotating beacon, front stabilizers, etc.).



19. Check tires for wear and pressure. Use only approved tires.

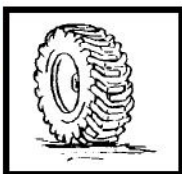

23. Recommend to the owner that all necessary corrections be made before the machine is returned to service.

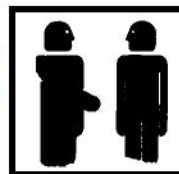

20. Inspect for loose or broken parts or connections.



**CALIFORNIA  
PROPOSITION 65 WARNING**  
Diesel engine exhaust and some of its constituents are known to the state of California to cause cancer, birth defects and other reproductive harm.

## SAFETY INSTRUCTIONS

 <b>Safety Alert Symbol</b>
This symbol with a warning statement means: “Warning, be alert! Your safety is involved!” Carefully read the message that follows.

 <b>WARNING</b>
--

Instructions are necessary before operating or servicing machine. Read and understand the Operation & Maintenance Manual, Operator's Handbook and signs (decals) on machine. Follow warnings and instructions in the manuals when making repairs, adjustments or servicing. Check for correct function after adjustments, repairs or service. Untrained operators and failure to follow instructions can cause injury or death.

W-2003-0903

<b>IMPORTANT</b>
------------------

This notice identifies procedures which must be followed to avoid damage to the machine.

I-2019-0284

 <b>DANGER</b>
---

The signal word DANGER on the machine and in the manuals indicates a hazardous situation which, if not avoided, will result in death or serious injury.

D-1002-1107

 <b>WARNING</b>
--

The signal word WARNING on the machine and in the manuals indicates a potentially hazardous situation which, if not avoided, could result in death or serious injury.

W-2044-1107

The following publications provide information on the safe use and maintenance of the Bobcat machine and attachments:

- The Delivery Report is used to assure that complete instructions have been given to the new owner and that the machine is in safe operating condition.
- The Operation & Maintenance Manual delivered with the machine or attachment contains operating information as well as routine maintenance and service procedures. It is a part of the machine and can be stored in a container provided on the machine. Replacement Operation & Maintenance Manuals can be ordered from your Bobcat dealer.
- Machine signs (decals) instruct on the safe operation and care of your Bobcat machine or attachment. The signs and their locations are shown in the Operation & Maintenance Manual. Replacement signs are available from your Bobcat dealer.
- An Operator's Handbook fastened to the operator cab. It's brief instructions are convenient to the operator. The handbook is available from your dealer in an English edition or one of many other languages. See your Bobcat dealer for more information on translated versions.
- The AEM Safety Manual delivered with the machine gives general safety information.
- The Service Manual and Parts Manual are available from your dealer for use by mechanics to do shop-type service and repair work.
- The VersaHANDLER Operator Training Course is available through your local dealer or at [www.training.bobcat.com](http://www.training.bobcat.com) or [www.bobcat.com](http://www.bobcat.com). This course is intended to provide rules and practices of correct operation of the VersaHANDLER.
- The VersaHANDLER Safety Video is available from your Bobcat dealer or at [www.training.bobcat.com](http://www.training.bobcat.com) or [www.bobcat.com](http://www.bobcat.com).

Dealer Copy -- Not for Resale

SI VH-0308 SM

## FIRE PREVENTION



### Maintenance

The machine and some attachments have components that are at high temperatures under normal operating conditions. The primary source of high temperatures is the engine and exhaust system. The electrical system, if damaged or incorrectly maintained, can be a source of arcs or sparks.

Flammable debris (leaves, straw, etc.) must be removed regularly. If flammable debris is allowed to accumulate, it can cause a fire hazard. Clean often to avoid this accumulation. Flammable debris in the engine compartment is a potential fire hazard.

The operator's area, engine compartment and engine cooling system must be inspected every day and cleaned if necessary to prevent fire hazards and overheating.

All fuels, most lubricants and some coolants mixtures are flammable. Flammable fluids that are leaking or spilled onto hot surfaces or onto electrical components can cause a fire.

### Operation

Do not use the machine where exhaust, arcs, sparks or hot components can contact flammable material, explosive dust or gases.

### Electrical



Check all electrical wiring and connections for damage. Keep the battery terminals clean and tight. Repair or replace any damaged part or wires that are loose or frayed.

Battery gas can explode and cause serious injury. Use the procedure in the Operation & Maintenance Manual for connecting the battery and for jump starting. Do not jump start or charge a frozen or damaged battery. Keep any open flames or sparks away from batteries. Do not smoke in battery charging area.

## Hydraulic System

Check hydraulic tubes, hoses and fittings for damage and leakage. Never use open flame or bare skin to check for leaks. Hydraulic tubes and hoses must be properly routed and have adequate support and secure clamps. Tighten or replace any parts that show leakage.

Always clean fluid spills. Do not use gasoline or diesel fuel for cleaning parts. Use commercial nonflammable solvents.

### Fueling



Stop the engine and let it cool before adding fuel. No smoking! Do not refuel a machine near open flames or sparks. Fill the fuel tank outdoors.

### Starting

Do not use ether or starting fluids on any engine that has glow plugs. These starting aids can cause explosion and injure you or bystanders.

Use the procedure in the Operation & Maintenance Manual for connecting the battery and for jump starting.

## Spark Arrestor Exhaust System

The spark arrestor exhaust system is designed to control the emission of hot particles from the engine and exhaust system, but the muffler and the exhaust gases are still hot.

Check the spark arrestor exhaust system regularly to make sure it is maintained and working properly. Use the procedure in the Operation & Maintenance Manual for cleaning the spark arrestor muffler (if equipped).

Dealer Copy - Not for Resale



## FIRE PREVENTION (CONT'D)

### Welding And Grinding

Always clean the machine and attachment, disconnect the battery, and disconnect the wiring from the Bobcat controllers before welding. Cover rubber hoses, battery and all other flammable parts. Keep a fire extinguisher near the machine when welding.

Have good ventilation when grinding or welding painted parts. Wear dust mask when grinding painted parts. Toxic dust or gas can be produced.

Dust generated from repairing nonmetallic parts such as hoods, fenders or covers can be flammable or explosive. Repair such components in a well ventilated area away from open flames or sparks.

### Fire Extinguishers

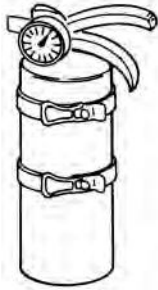

Know where fire extinguishers and first aid kits are located and how to use them. Inspect the fire extinguisher and service the fire extinguisher regularly. Obey the recommendations on the instructions plate.

## SERIAL NUMBER LOCATION

Always use the serial number of the VersaHANDLER when requesting service information or when ordering parts. Early or later models (identification made by serial number) may use different parts, or it may be necessary to use a different procedure in doing a specific service operation.

### VersaHANDLER Serial Number

Figure 1



The VersaHANDLER serial number plate is located on the right front side of the chassis (Item 1) [Figure 1].

Figure 2

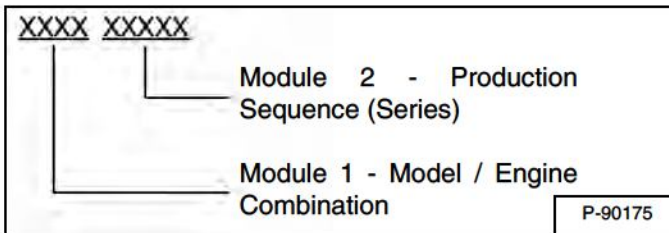

Explanation of VersaHANDLER Serial Number [Figure 2]:

1. The four digit Model / Engine Combination Module number identifies the model number and engine combination.
2. The five digit Production Sequence Number identifies the order which the VersaHANDLER is produced.

## Engine Serial Number

Figure 3



The engine serial number can be found on top of the valve cover (Item 1) [Figure 3]. Always use the full number when ordering replacement parts.

### Other Serial Numbers

Other components may also have serial numbers and an identification plate. Always use these serial numbers when ordering parts.

## DELIVERY REPORT

Figure 4

The diagram shows a form layout with a header section at the top right, a warning box on the left, and two columns of text input fields. A small box at the bottom right contains the code B-16315.

The Delivery Report must be filled out by the dealer and signed by the owner or operator when the VersaHANDLER is delivered. An explanation of the form must be given to the owner. Make sure it is filled out completely **[Figure 4]**.

**VERSAHANDLER IDENTIFICATION**

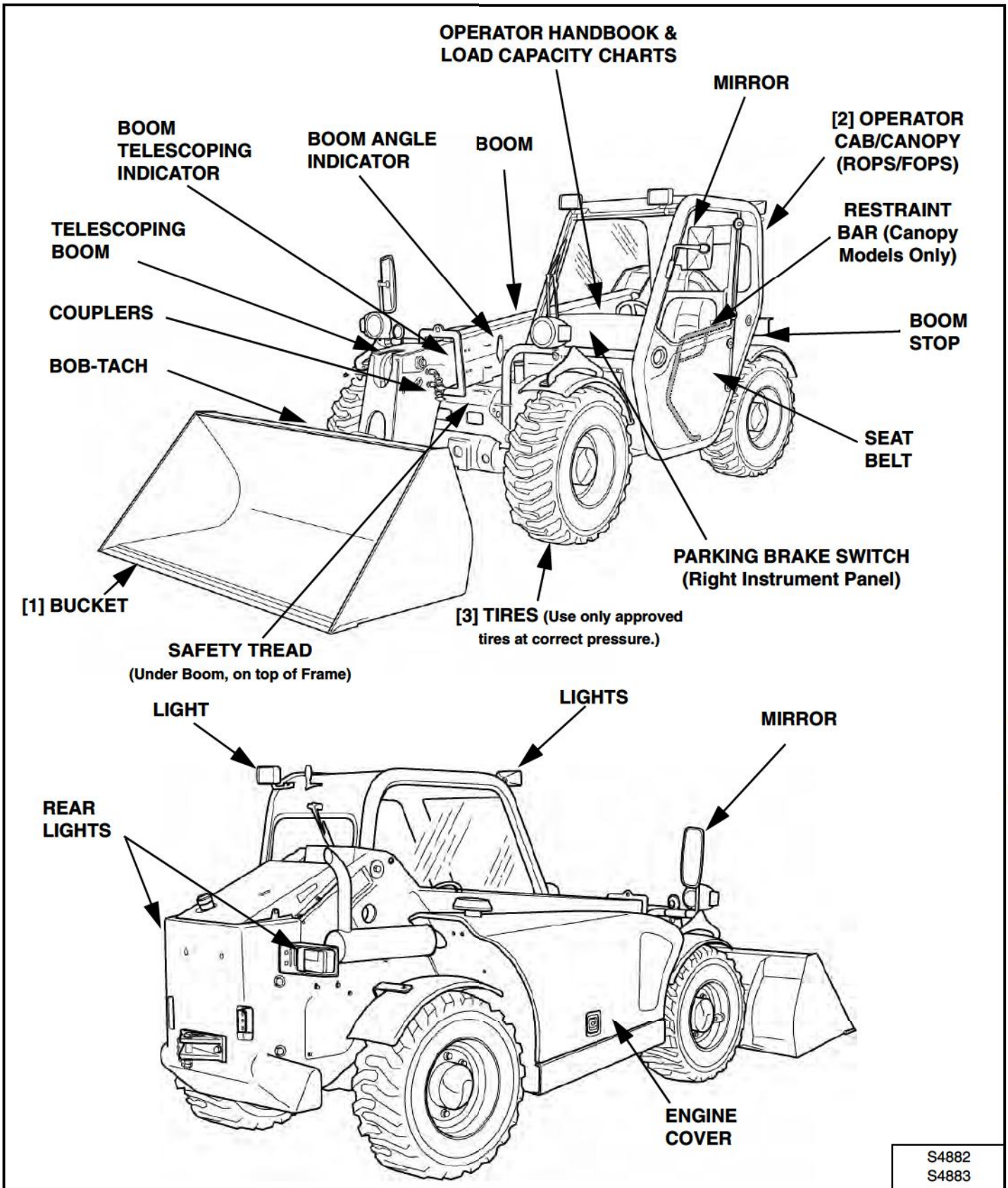

Dealer Copy -- Not for Resale

- [1] BUCKETS - Several different buckets and other attachments are available for the Bobcat loader.
- [2] ROPS, FOPS - Roll Over Protective Structure, per ISO 3471, and Falling Object Protective Structure per ISO 3449, Level I.
- [3] TIRES - Standard tires are shown. Several different tire styles and sizes are available for the Bobcat loader.

S4882  
S4883

## SAFETY & MAINTENANCE

LIFTING AND BLOCKING THE VERSAHANDLER .....	10-10-1
Procedure .....	10-10-1
OPERATOR CAB / CANOPY .....	10-20-1
Cab Door .....	10-20-1
Cab Door Window .....	10-20-2
TRANSPORTING THE VERSAHANDLER ON A TRAILER .....	10-30-1
Loading And Unloading .....	10-30-1
Fastening .....	10-30-1
TOWING THE VERSAHANDLER .....	10-40-1
Releasing The Brake Discs .....	10-40-1
Towing .....	10-40-2
Engaging The Brake Discs .....	10-40-2
SERVICE SCHEDULE .....	10-50-1
Chart .....	10-50-1
AIR CLEANER SERVICE .....	10-60-1
Replacing The Filter Element .....	10-60-1
ENGINE COOLING SYSTEM .....	10-70-1
Cleaning .....	10-70-1
Removing And Replacing The Coolant .....	10-70-2
Checking Level .....	10-70-3
FUEL SYSTEM .....	10-80-1
Fuel Specifications .....	10-80-1
Filling The Fuel Tank .....	10-80-1
Fuel Filter .....	10-80-2
ENGINE LUBRICATION SYSTEM .....	10-90-1
Checking Engine Oil .....	10-90-1
Oil Chart .....	10-90-1
Replacing Oil And Filter .....	10-90-1
HYDRAULIC / HYDROSTATIC SYSTEM .....	10-100-1
Checking And Adding Fluid .....	10-100-1
Replacing The Hydraulic / Hydrostatic Filters .....	10-100-1
Replacing Hydraulic Fluid .....	10-100-2

**Buy Now**



Our support email:

[ebooklibonline@outlook.com](mailto:ebooklibonline@outlook.com)