

Wheeled Loading Shovel - 426, 436, 446

[Section 1 - General Information](#)

[Section 2 - Care and Safety](#)

[Section 3 - Routine Maintenance](#)

[Section A - Attachments](#)

[Section B - Body and Framework](#)

[Section C - Electrics](#)

[Section E - Hydraulics](#)

[Section F - Transmission](#)

[Section G - Brakes](#)

[Section H - Hydraulic Steering](#)

[Section K - Engine](#)



Publication No.
9803-4160-16



Copyright © 2004 JCB SERVICE. All rights reserved. No part of this publication may be reproduced, stored in a retrieval system, or transmitted in any form or by any other means, electronic, mechanical, photocopying or otherwise, without prior permission from JCB SERVICE.



Section 1 - General Information

Contents	Page No.
Introduction	
About this Manual	1 - 1
Machine Model and Serial Number	1 - 1
Using the Service Manual	1 - 1
Section Numbering	1 - 1
Left Side, Right Side	1 - 2
Cross References	1 - 2
Identifying Your Machine	1 - 3
Machine Identification Plate	1 - 3
Component Identification Plates	1 - 5
Standard Torque Settings	
Zinc Plated Fasteners and Dacromet Fasteners	1 - 7
Introduction	1 - 7
Bolts and Screws	1 - 7
Hydraulic Connections	1 - 11
'O' Ring Face Seal System	1 - 11
'Torque Stop' Hose System	1 - 14
Service Tools	
Numerical List	1 - 15
Tool Detail Reference	1 - 16
Section B - Body and Framework	1 - 16
Section C - Electrics	1 - 20
Section E- Hydraulics	1 - 22
Section F - Transmission	1 - 30
Section H - Steering	1 - 33
Section K - Engine	1 - 33
Service Consumables	
Sealing and Retaining Compounds	1 - 35
Terms and Definitions	
Colour Coding	1 - 37
Hydraulic Schematic Colour Codes	1 - 37



Section 1 - General Information

Contents

Page No.

Introduction

About this Manual

Machine Model and Serial Number

This manual provides information for the following model(s) in the JCB machine range:

- 426 Wheeled Loading Shovel from machine serial number 531001
- 436 Wheeled Loading Shovel from machine serial number 533001
- 446 Wheeled Loading Shovel from machine serial number 540000 to 540011

Note: *The information provided in this manual for the 436 machine also applies to the 446 machine, except where specified.*

Note: *USA ONLY - For 426 machines built after November 1998, Hydraulic and Electrical Information is as for 436 machines. Also, machine serial numbers start at 544001.*

Note: *USA ONLY - For 426 machines built after October 2000, Hydraulic and Electrical Information is as for 426 machines. Also, machine serial numbers revert to the normal 426 series.*

Using the Service Manual

T11-004

This publication is designed for the benefit of JCB Distributor Service Engineers who are receiving, or have received, training by JCB Technical Training Department.

These personnel should have a sound knowledge of workshop practice, safety procedures, and general techniques associated with the maintenance and repair of hydraulic earthmoving equipment.

The illustrations in this publication are for guidance only. Where the machines differ, the text and/or the illustration will specify.

General warnings in Section 2 are repeated throughout the manual, as well as specific warnings. Read all safety statements regularly, so you do not forget them.

Renewal of oil seals, gaskets, etc., and any component showing obvious signs of wear or damage is expected as

a matter of course. It is expected that components will be cleaned and lubricated where appropriate, and that any opened hose or pipe connections will be blanked to prevent excessive loss of hydraulic fluid and ingress of dirt.

Where a torque setting is given as a single figure it may be varied by plus or minus 3%. Torque figures indicated are for dry threads, hence for lubricated threads may be reduced by one third.

The manufacturer's policy is one of continuous improvement. The right to change the specification of the machine without notice is reserved. No responsibility will be accepted for discrepancies which may occur between specifications of the machine and the descriptions contained in this publication.

Finally, please remember above all else safety must come first!

Section Numbering

T11-005

The manual is compiled in sections, the first three are numbered and contain information as follows:

- 1 General Information - includes torque settings and service tools.
- 2 Care and Safety - includes warnings and cautions pertinent to aspects of workshop procedures etc.
- 3 Maintenance - includes service schedules and recommended lubricants for all the machine.

The remaining sections are alphabetically coded and deal with Dismantling, Overhaul etc. of specific components, for example:

- A Attachments
- B Body and Framework, etc.

Section contents, technical data, circuit descriptions, operation descriptions etc. are inserted at the beginning of each alphabetically coded section.

Left Side, Right Side

In this manual, 'left' **A** and 'right' **B** mean your left and right when you are seated correctly in the machine.

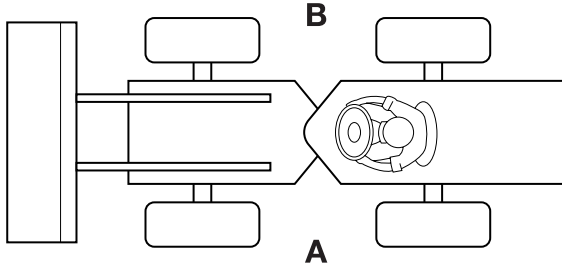

Fig 1.

Cross References

T1-004_2

In this publication, page cross references are made by presenting the subject title printed in bold, italic and underlined. It is preceded by the 'go to' symbol. The number of the page upon which the subject begins, is indicated within the brackets. For example: [⇒ ***Cross References*** \(***1-2***\).](#)

Identifying Your Machine

Machine Identification Plate

Your machine has an identification plate mounted as shown. The serial numbers of the machine and its major units are stamped on the plate.

Note: The machine model and build specification is indicated by the VIN (earlier machines) or PIN (later machines). Refer to **Typical Vehicle Identification Number (VIN)** or **Typical Product Identification Number (PIN)**.

The serial number of each major unit is also stamped on the unit itself. If a major unit is replaced by a new one, the serial number on the identification plate will be wrong. Either stamp the new number of the unit on the identification plate, or simply stamp out the old number. This will prevent the wrong unit number being quoted when replacement parts are ordered.

The machine and engine serial numbers can help identify exactly the type of equipment you have.

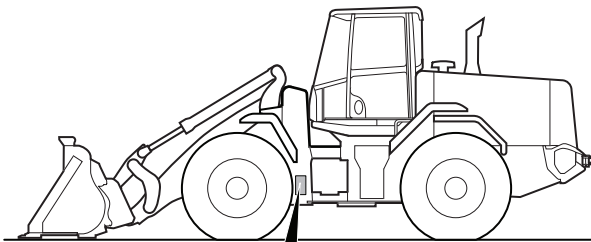

J.C.B. EARTHMOVERS LIMITED LAKESIDE WORKS, ROCESTER UTTOXETER, UNITED KINGDOM ST14 5JP	
VIN Vehicle Identification Number	PIN Product Identification Number
ENGINE SERIAL NUMBER	FRONT AXLE SERIAL NUMBER
TRANSMISSION SERIAL NUMBER	REAR AXLE SERIAL NUMBER
WEIGHT kg	YEAR OF CONST.
	ENGINE POWER kW @ RPM
MACHINE TYPE	HOMOLOGATION No.

Fig 2.

Typical Vehicle Identification Number

1	2	3	4	5
SLP	42600	S	E	0531001

- 1 World Manufacturer Identification, SLP = JCB
- 2 Machine Model, 42600 = 426
- 3 Year of Manufacture S, (P = 1993, R = 1994, S = 1995, T = 1996, V = 1997, W = 1998, X = 1999, Y = 2000, 1 = 2001, 2 = 2002, 3 = 2003, 4 = 2004)
- 4 Manufacturing Location (E = England)
- 5 Machine Serial Number (0531001)

The serial number of each major unit is also stamped on the unit itself. If a major unit is replaced by a new one, the serial number on the identification plate will be wrong. Either stamp the new number of the unit on the identification plate, or simply stamp out the old number. This will prevent the wrong unit number being quoted when replacement parts are ordered.

The machine and engine serial numbers can help identify exactly the type of equipment you have.

Typical Product Identification Number

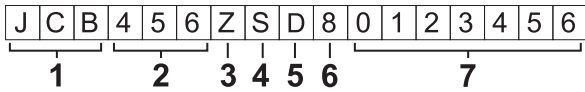

Fig 3.

1 World Manufacturer Identification (3 Digits)

2 Model Number (3 Digits)

3 Loader End Type (1 Digit)

O = HT Loader End

Z = ZX Loader End

4 Designation (1 Digit)

S = Farmmaster

O = None Farmmaster

I = India

5 Check Letter (1 Digit)

The Check Letter is used to verify the authenticity of the machine's PIN.

6 Year of Manufacture (1 Digit)

7 = 2007

A = 2010

8 = 2008

B = 2011

9 = 2009

C = 2012

7 Machine Serial Number (7 Digits)

Each machine has a unique serial number.

Note: On later models, the year of manufacture digit was removed and the machine serial number was increased to 8 digits.

Component Identification Plates

Typical Engine Identification Number

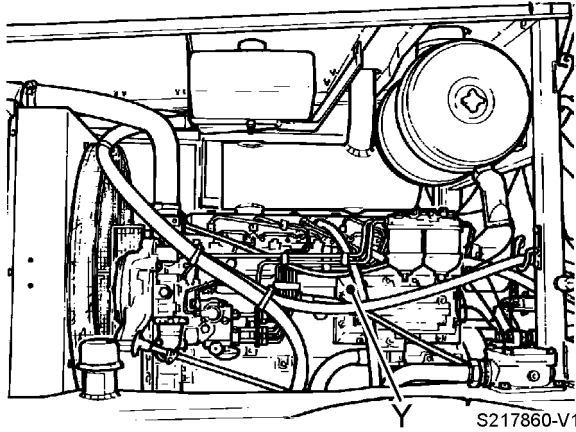

Fig 4.

The engine serial number is stamped on a plate **4Y** which is fastened to the right side of the cylinder block, near the fuel filter.

1	2	3	4	5
YB	50457	U	576887	Y

- 1 Engine Type, YB = 6 cylinder turbo
- 2 Build Number
- 3 Country of Origin
- 4 Engine Sequence Number
- 5 Year of Manufacture

The Transmission serial number is stamped on plate **5Z** as shown.

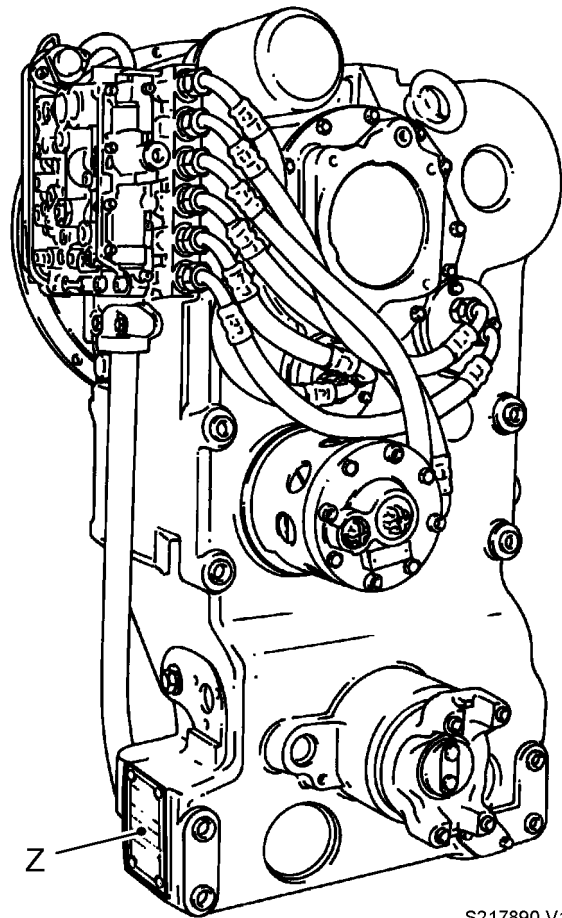

Fig 5.

S217890-V1

FOPS Data Plate

WARNING

Do not use the machine if the falling objects protection level provided by the structure is not sufficient for the application. Falling objects can cause serious injury.

8-2-8-17

If the machine is used in any application where there is a risk of falling objects then a falling-objects protective structure (FOPS) must be installed. For further information contact your JCB Dealer

The falling objects protection structure (FOPS) is fitted with a dataplate. The dataplate indicates what level protection the structure provides.

There are two levels of FOPS:

- **Level I Impact Protection** - impact strength for protection from small falling objects (e.g. bricks, small concrete blocks, hand tools) encountered in operations such as highway maintenance, landscaping and other construction site services.
- **Level II Impact Protection** - impact strength for protection from heavy falling objects (e.g. trees, rocks) for machines involved in site clearing, overhead demolition or forestry.

ROPS Data Plate

WARNING

You could be killed or seriously injured if you operate a machine with a damaged or missing ROPS/FOPS. If the Roll Over Protection Structure (ROPS)/Falling Objects Protection Structure (FOPS) has been in an accident, do not use the machine until the structure has been renewed. Modifications and repairs that are not approved by the manufacturer may be dangerous and will invalidate the ROPS/FOPS certification.

INT-2-1-9_6

WARNING

Seat Belts

The ROPS/FOPS is designed to give you protection in an accident. If you do not wear your seat belt, you could be thrown out of the machine and crushed. You must wear a seat belt when using the machine. Fasten the seat belt before starting the engine.

0153

Machines built to the ROPS/FOPS standard have a data plate attached to the inside of the cab.

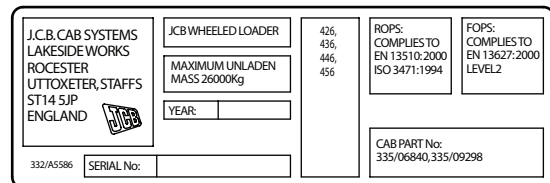

Fig 6.

Standard Torque Settings

Zinc Plated Fasteners and Dacromet Fasteners

T11-002

Introduction

Some external fasteners on JCB machines are manufactured using an improved type of corrosion resistant finish. This type of finish is called Dacromet and replaces the original Zinc and Yellow Plating used on earlier machines.

The two types of fasteners can be readily identified by colour and part number suffix. ⇒ [Table 1. Fastener Types](#) (1-7).

Table 1. Fastener Types

Fastener Type	Colour	Part No. Suffix
Zinc and Yellow	Golden finish	'Z' (e.g. 1315/3712Z)
Dacromet	Mottled silver finish	'D' (e.g. 1315/3712D)

Note: As the Dacromet fasteners have a lower torque setting than the Zinc and Yellow fasteners, the torque figures used must be relevant to the type of fastener.

Note: A Dacromet bolt should not be used in conjunction with a Zinc or Yellow plated nut, as this could change the torque characteristics of the torque setting further. For the same reason, a Dacromet nut should not be used with a Zinc or Yellow plated bolt.

Note: All bolts used on JCB machines are high tensile and must not be replaced by bolts of a lesser tensile specification.

Note: Dacromet bolts, due to their high corrosion resistance are used in areas where rust could occur. Dacromet bolts are only used for external applications. They are not used in applications such as gearbox or engine joint seams or internal applications.

Bolts and Screws

Use the following torque setting tables only where no torque setting is specified in the text.

Note: Dacromet fasteners are lubricated as part of the plating process, do not lubricate.

Torque settings are given for the following conditions:

Condition 1

- Un-lubricated fasteners
- Zinc fasteners
- Yellow plated fasteners

Condition 2

- Zinc flake (Dacromet) fasteners
- Lubricated zinc and yellow plated fasteners
- Where there is a natural lubrication. For example, cast iron components

Verbus Ripp Bolts

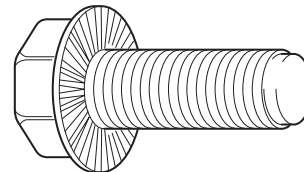

Fig 1.

Torque settings for these bolts are determined by the application. Refer to the relevant procedure for the required settings.



Section 1 - General Information Standard Torque Settings

Zinc Plated Fasteners and Dacromet Fasteners

Table 2. Torque Settings - UNF Grade 'S' Fasteners

Bolt Size		Hexagon (A/F)	Condition 1			Condition 2		
in.	mm	in.	Nm	kgf m	lbf ft	Nm	kgf m	lbf ft
1/4	6.3	7/16	11.2	1.1	8.3	10.0	1.0	7.4
5/16	7.9	1/2	22.3	2.3	16.4	20.0	2.0	14.7
3/8	9.5	9/16	40.0	4.1	29.5	36.0	3.7	26.5
7/16	11.1	5/8	64.0	6.5	47.2	57.0	5.8	42.0
1/2	12.7	3/4	98.0	10.0	72.3	88.0	9.0	64.9
9/16	14.3	13/16	140.0	14.3	103.2	126.0	12.8	92.9
5/8	15.9	15/16	196.0	20.0	144.6	177.0	18.0	130.5
3/4	19.0	1 1/8	343.0	35.0	253.0	309.0	31.5	227.9
7/8	22.2	1 15/16	547.0	55.8	403.4	492.0	50.2	362.9
1	25.4	1 1/2	814.0	83.0	600.4	732.0	74.6	539.9
1 1/8	31.7	1 7/8	1181.0	120.4	871.1	1063.0	108.4	784.0
1 1/4	38.1	2 1/4	1646.0	167.8	1214.0	1481.0	151.0	1092.3

Table 3. Torque Settings - Metric Grade 8.8 Fasteners

Bolt Size		Hexagon (A/F)	Condition 1			Condition 2		
ISO Metric Thread	mm	mm	Nm	kgf m	lbf ft	Nm	kgf m	lbf ft
M5	5	8	5.8	0.6	4.3	5.2	0.5	3.8
M6	6	10	9.9	1.0	7.3	9.0	0.9	6.6
M8	8	13	24.0	2.4	17.7	22.0	2.2	16.2
M10	10	17	47.0	4.8	34.7	43.0	4.4	31.7
M12	12	19	83.0	8.5	61.2	74.0	7.5	54.6
M16	16	24	205.0	20.9	151.2	184.0	18.8	135.7
M20	20	30	400.0	40.8	295.0	360.0	36.7	265.5
M24	24	36	690.0	70.4	508.9	621.0	63.3	458.0
M30	30	46	1372.0	139.9	1011.9	1235.0	125.9	910.9
M36	36	55	2399.0	244.6	1769.4	2159.0	220.0	1592.4



Section 1 - General Information Standard Torque Settings

Zinc Plated Fasteners and Dacromet Fasteners

Table 4. Metric Grade 10.9 Fasteners

Bolt Size		Hexagon (A/F)	Condition 1			Condition 2		
ISO Metric Thread	mm	mm	Nm	kgf m	lbf ft	Nm	kgf m	lbf ft
M5	5	8	8.1	0.8	6.0	7.3	0.7	5.4
M6	6	10	13.9	1.4	10.2	12.5	1.3	9.2
M8	8	13	34.0	3.5	25.0	30.0	3.0	22.1
M10	10	17	67.0	6.8	49.4	60.0	6.1	44.2
M12	12	19	116.0	11.8	85.5	104.0	10.6	76.7
M16	16	24	288.0	29.4	212.4	259.0	26.4	191.0
M20	20	30	562.0	57.3	414.5	506.0	51.6	373.2
M24	24	36	971.0	99.0	716.9	874.0	89.1	644.6
M30	30	46	1930.0	196.8	1423.5	1737.0	177.1	1281.1
M36	36	55	3374.0	344.0	2488.5	3036.0	309.6	2239.2

Table 5. Metric Grade 12.9 Fasteners

Bolt Size		Hexagon (A/F)	Condition 1			Condition 2		
ISO Metric Thread	mm	mm	Nm	kgf m	lbf ft	Nm	kgf m	lbf ft
M5	5	8	9.8	1.0	7.2	8.8	0.9	6.5
M6	6	10	16.6	1.7	12.2	15.0	1.5	11.1
M8	8	13	40.0	4.1	29.5	36.0	3.7	26.5
M10	10	17	80.0	8.1	59.0	72.0	7.3	53.1
M12	12	19	139.0	14.2	102.5	125.0	12.7	92.2
M16	16	24	345.0	35.2	254.4	311.0	31.7	229.4
M20	20	30	674.0	68.7	497.1	607.0	61.9	447.7
M24	24	36	1165.0	118.8	859.2	1048.0	106.9	773.0
M30	30	46	2316.0	236.2	1708.2	2084.0	212.5	1537.1
M36	36	55	4049.0	412.9	2986.4	3644.0	371.6	2687.7



Section 1 - General Information Standard Torque Settings

Zinc Plated Fasteners and Dacromet Fasteners

Table 6. Torque Settings - Rivet Nut Bolts/Screws

Bolt Size		Nm	kgf m	lbf ft
ISO Metric Thread	mm			
M3	3	1.2	0.1	0.9
M4	4	3.0	0.3	2.0
M5	5	6.0	0.6	4.5
M6	6	10.0	1.0	7.5
M8	8	24.0	2.5	18.0
M10	10	48.0	4.9	35.5
M12	12	82.0	8.4	60.5

Table 7. Torque Settings - Internal Hexagon Headed Cap Screws (Zinc)

Bolt Size	Nm	kgf m	lbf ft
ISO Metric Thread			
M3	2.0	0.2	1.5
M4	6.0	0.6	4.5
M5	11.0	1.1	8.0
M6	19.0	1.9	14.0
M8	46.0	4.7	34.0
M10	91.0	9.3	67.0
M12	159.0	16.2	117.0
M16	395.0	40.0	292.0
M18	550.0	56.0	406.0
M20	770.0	79.0	568.0
M24	1332.0	136.0	983.0

Buy Now



Our support email:

ebooklibonline@outlook.com