

Service Manual

HM Range Medium and Large Hydraulic Breakers, Serial Nos. 1095001 onwards

PUBLISHED BY THE
JCB ATTACHMENTS
RIVERSIDE, RUGELEY
STAFFORDSHIRE, WS15 2WA
ENGLAND
Tel. ROCESTER (01889) 572700
PRINTED IN ENGLAND
Publication No. 9803/1420_02

HM Medium Breakers 1

HM Large Breakers 2

HM Range Medium and Large Hydraulic Breakers, Serial Nos. 1095001 onwards

Section 1 Medium Breakers

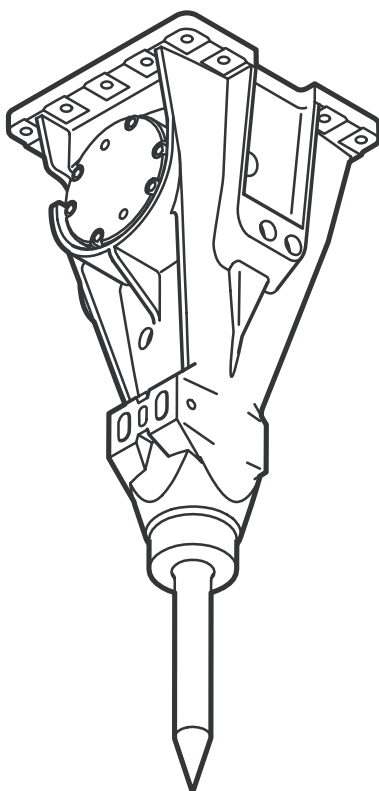

Publication No.
9803/1420-02



Copyright © 2004 JCB SERVICE. All rights reserved. No part of this publication may be reproduced, stored in a retrieval system, or transmitted in any form or by any other means, electronic, mechanical, photocopying or otherwise, without prior permission from JCB SERVICE.



Chapter	Page
Introduction	1
Safety Regulation	1
General	1
Workshop Standards	1
Service Personnel	1
Layout of the Instructions	1
Symbols	2
List of Tools/Standard Tools	4
Charging Equipment	6
Disassemble Accumulator	7
Disassemble Piston	10
Assemble Bushing and Piston	14
Assemble Accumulator	18
Field Bushing Exchange	21
Charge Accumulator	23
Exploded Views	25
Appendix - Breaker Operating Principles	29
Technical Specifications	33
Nitrogen Adaptor Reference Chart	35
Tool Part Numbers	36
Breaker Part Number Matrix	37

Safety regulation



This symbol, plus a word, is used to draw your attention to safety hazards. Read the instructions accompanying this symbol carefully.

The words WARNING and CAUTION have the following significance:

- | | |
|---------|---|
| WARNING | Indicates a hazard or hazardous procedures which COULD result in serious injury or death if the warning is not observed. |
| CAUTION | Indicates a hazard or hazardous procedures which COULD result in injury or damage to equipment if the warning is not observed. |

General

The following instructions are intended to guide service personnel in the repair or overhauling of the JCB Medium Breakers.



WARNING

Never intervene in the breaker when it is connected to the hydraulic system, or when the accumulator is charged!

Workshop standards

JCB HM Breakers have hydraulically powered percussion mechanisms. Since all hydraulically powered equipment is sensitive to dirt, the breakers must always be disassembled in a place that is:

- Isolated from all dust and particle-generating activities such as grinding and welding.
- Very clean, i.e. free of dust and dirt.
- Equipped with washing facilities and compressed air for the blow cleaning of components.
- Equipped with all necessary standard and special tools.



WARNING

The tool must not be modified without the manufacturer's permission. Use only original parts and accessories approved by JCB Service. If modifications are made that are not approved by JCB Service, serious harm to yourselves or others may result.

All users of this instruction manual are asked to inform JCB Attachments if they find any errors or discrepancies, especially any affecting product safety.

Use only authorized parts. Any damage or malfunction caused by the use of unauthorized parts will not be covered by any Warranty or Product Liability.

Any unauthorized use or copying of the contents of this manual or any part hereof is prohibited. This applies in particular to trademarks, model denominations, part numbers and drawings.









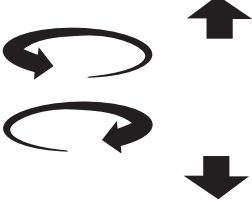

Service Personnel

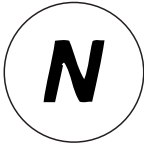



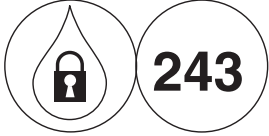

This publication is designed for the benefit of JCB Distributor Service Engineers who are receiving, or have received, training by the JCB Training Centre or by JCB Service Personnel. These personnel should have a sound knowledge of workshop practice, safety procedures and general techniques associated with the maintenance and repair of hydraulic equipment.











Renewal of seals, gaskets etc. and any component showing obvious signs of wear or damage is expected as a matter of course. It is expected that components will be cleaned and lubricated where appropriate, and that any opened hose or pipe connections will be blanked to prevent excessive loss of hydraulic fluid and ingress of dirt. Finally, please remember above all else - SAFETY MUST COME FIRST!

Layout of the instructions

The instructions begin with a list of the standard symbols and special tools needed to overhaul the breakers. This is followed by instructions on how to disassemble the breaker into its main parts. Then, under sub-headings for each of the main parts, detailed instructions are given on further disassembly, the checking and inspection of parts, and reassembly.

 <p>Important positional relationship</p>	 <p>Direction</p>	 <p>Inspect and replace damaged parts</p>
 <p>New part</p>	 <p>To be avoided</p>	 <p>Okay</p>
 <p>Force</p>	 <p>Turning to end position</p>	 <p>Oil</p>
 <p>Loctite 243</p>	 <p>Gas release</p>	 <p>Scrap</p>

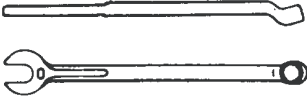
 <p>Contact sound</p>	 <p>Minutes</p>	 <p>Grease</p>
 <p>Frozen</p>	 <p>Torque</p>	 <p>On the excavator</p>

	<p>1. Plastic hammer</p>
	<p>2. Allen socket: 5, 8, 14 mm</p>
	<p>3. Screwdriver</p>
	<p>4. Punch Ø 10 mm</p>
	<p>5. Torque wrench 0 - 650 Nm</p>
	<p>6. Allen sockets for torque wrench 5, 8, 14 mm</p>
	<p>7. Vernier Gauge</p>
	<p>8. Ratchet wrench</p>
	<p>9. Scriber</p>
	<p>10. Open-ended spanners 13,14,15,19, 24, 30, 36 mm</p>
	<p>11. Sockets for torque wrench 24, 30, 36 mm</p>

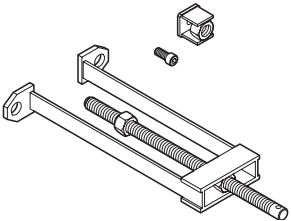
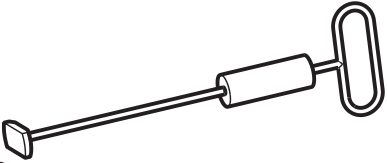
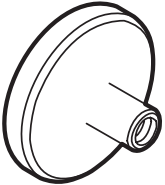
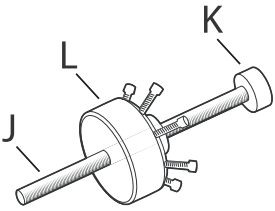
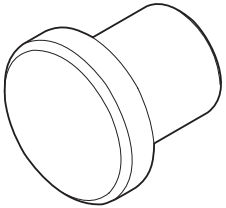
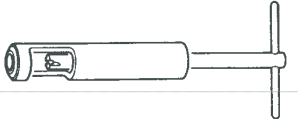
JCB Part No.			
<p>A</p> 		Shackle	Disassembly/ assembly of piston and liner package
<p>B</p> 		Extractor	Removal of piston guide
<p>C</p> 		Mandrel	Fitting of liner assembly
<p>D</p> 		J Screw K Sleeve L Guide	Removal of bushing
<p>E</p> 		Mandrel	Assembly of bushing
<p>F</p> 		Assembly tool	Helicoil thread inserts

JCB Part No.

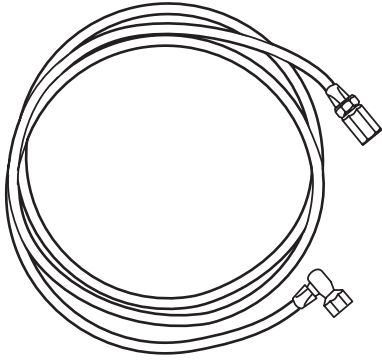
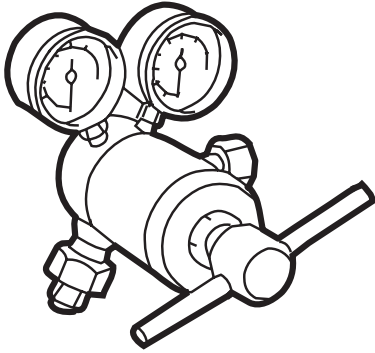
		<p>Charging hose, compl. - Nipple - Nipple</p>	<p>Hose for charging of accumulator</p>
		<p>Gas regulator, compl. -Pressure gauge</p>	<p>Charging of high pressure accumulator</p>

⚠ WARNING

The accumulator is pressurized even when there is no hydraulic pressure to it. Attempting to dismantle the accumulator without first releasing the pressure may cause injury. Before dismantling accumulator, make sure that the gas pressure is released completely.

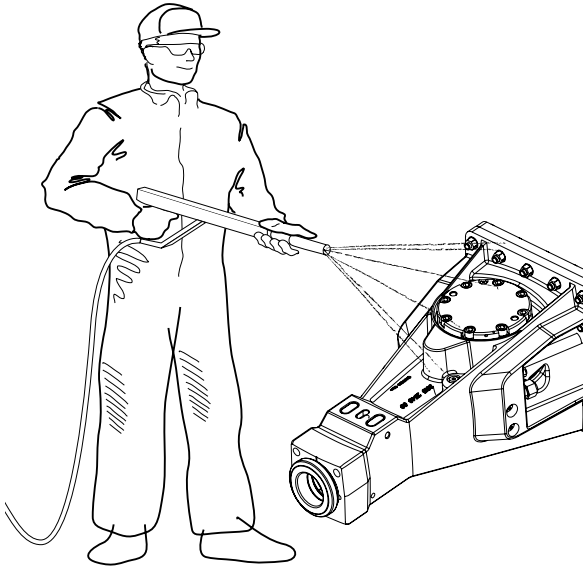

Fig. 1

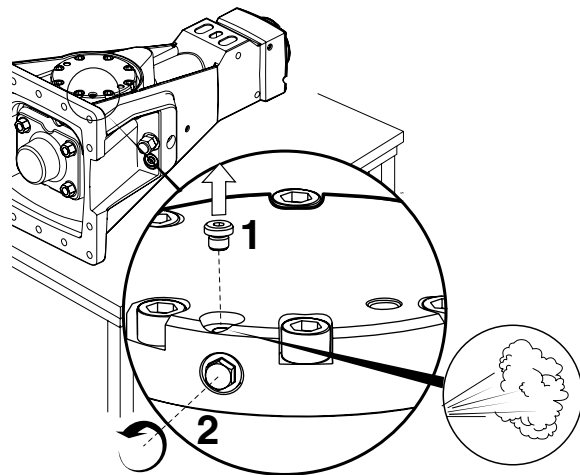

Fig. 2

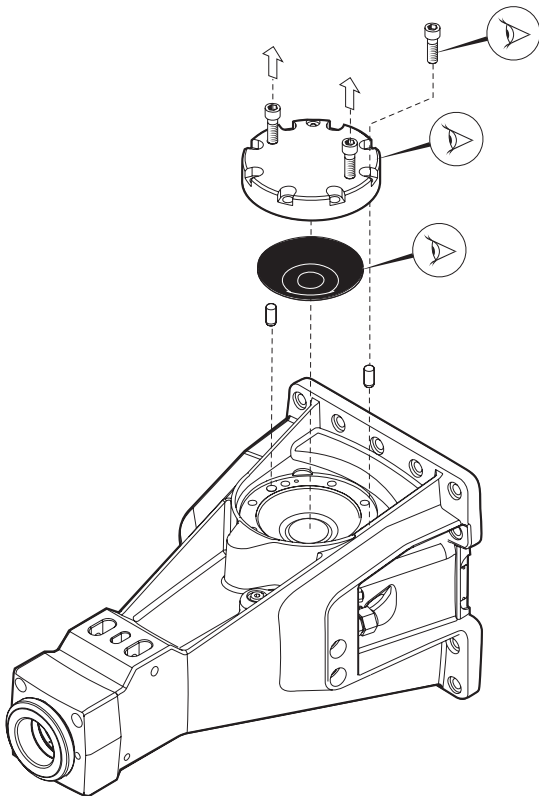

Fig. 3

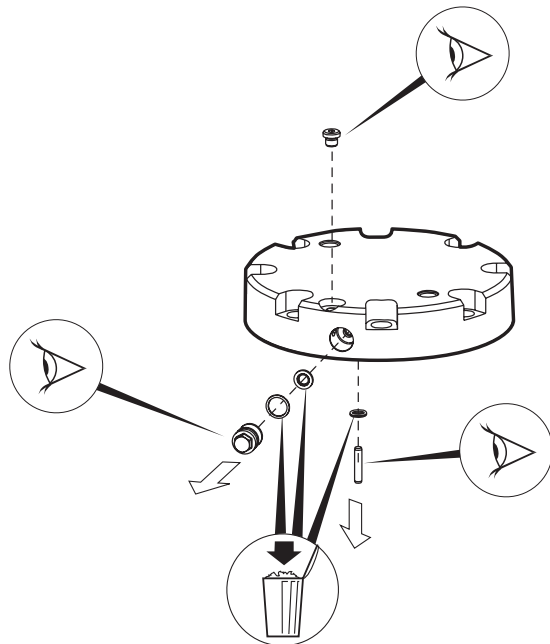

Fig. 4

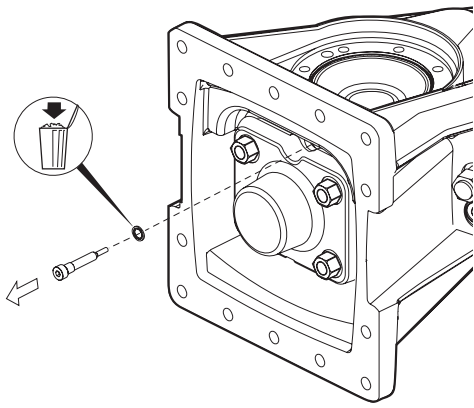

Fig. 5

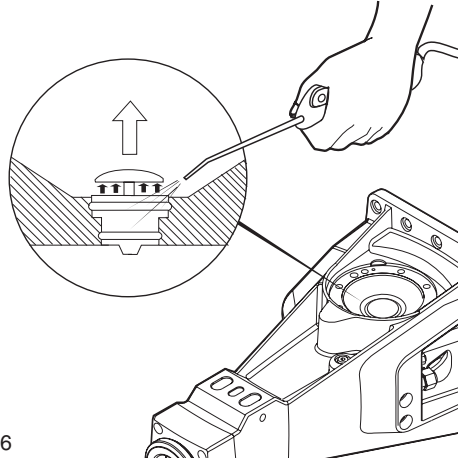

Fig. 6

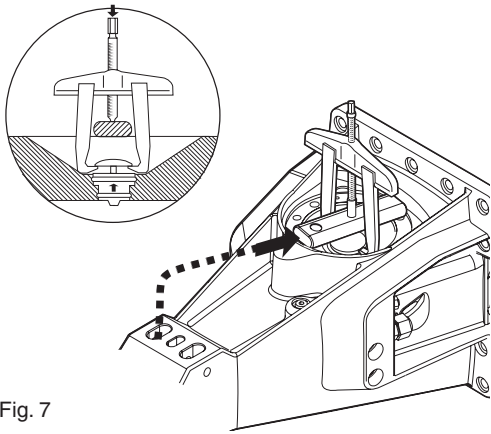

Fig. 7

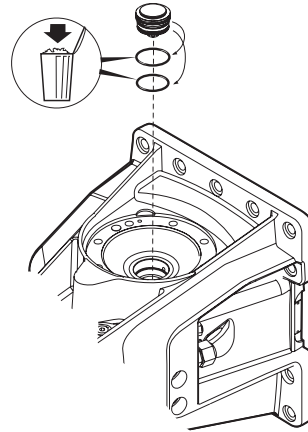

Fig. 8



Fig. 9

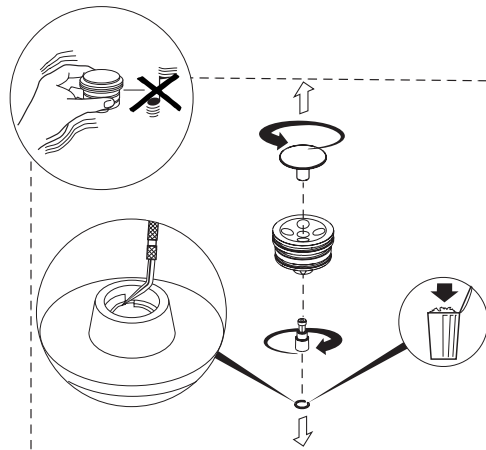

Fig. 10

Buy Now



Our support email:

ebooklibonline@outlook.com