

**INDUSTRIAL
DIESEL ENGINE
AA-6HK1T, BB-6HK1T
MODELS**

WORKSHOP MANUAL

ISUZU MOTORS LIMITED

NOTICE

Before using this Workshop Manual to assist you in performing service and maintenance operations, it is recommended that you carefully read and thoroughly understand the information contained in Section 00 under the heading "GENERAL INFORMATION".

**All material contained in this Manual is based on latest product information available at the time of publication.
All rights are reserved to make changes at any time without prior notice.**

This manual is applicable to 2000 model year engines.

THIS MANUAL INCLUDES THE FOLLOWING SECTIONS:

SECTION NO.	CONTENTS
00	General Information
6A	Engine Mechanical
6B	Engine Cooling
6C	Engine Fuel
6D	Starting and Charging
6E	—
6F	—
6G	Engine Lubrication
6J	Engine Induction

GENERAL INFORMATION

CONTENTS

General Information	0A
Service Information	0B

GENERAL INFORMATION

CONTENTS







General Repair Instruction	0A-1	Engine External View Drawing	0A-11
Illustration Arrows	0A-2	Service Standard	0A-12
Abbreviations	0A-3	Torque Specifications	0A-16
Nut and Bolt Angular Tightening Method	0A-4	Special Tools	0A-24
Standard Bolt Torque Specifications	0A-6	Troubleshooting	0A-25
Recommended Thread Locking Agents	0A-8	Lubricant Application	0A-35
Main Data and Specifications	0A-9	Sealant Application	0A-35



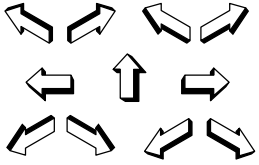

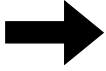
General Repair Instruction

- Before performing service operations, disconnect the ground cable from the battery to reduce the chance of cable damage and burning due to short circuiting.
- Use a cover on body, seats and floor to protect them against damage and contamination.
- Brake fluid and anti-freeze solution must be handled with care because they can cause paint damage.
- The use of proper tools and special tools, where specified, is important for efficient and reliable performance of service repairs.
- Use genuine Isuzu parts.
- Used cotter pins, plastic clips, gaskets, O-rings oil seals, lock washers, and self-locking nuts should be discarded and new ones should be installed. Normal function of the parts cannot be maintained if these parts are reused.
- To facilitate proper and smooth reassembly operation, keep disassembled parts neatly in groups. Keeping fixing nuts and bolts separate is very important, as they vary in hardness and design depending on position of installation.
- Clean the parts before inspection or reassembly. Also clean oil ports, etc. using compressed air, and make certain they are free from restrictions.
- Lubricate rotating and sliding faces of the parts with oil or grease before installation.
- When necessary, use a sealer on gaskets to prevent leakage.
- Carefully observe all specifications for nut and bolt torques.
- When a service operation is completed, make a final check to be sure the service has been done properly and the problem has been corrected.
- Allow the engine to cool before beginning any service procedure.
This will eliminate the danger of fire and possible injury.
- Hot steam under pressure may escape from the radiator if the coolant is drained while the engine is hot. This can result in serious burns. Allow the engine to cool before draining the coolant.
- Hot engine oil can cause severe skin burns. Allow the engine to cool before draining the engine oil.
- While working around a running engine, avoid contact with moving parts and hot surfaces to prevent injury.
- Wear safety glasses when using compressed air. Flying particles may cause eye injury.
- Always wear safety goggles when working with fuel to protect the eyes from fuel splash.
- Test fluid from the injection nozzle tester will spray out of the injection nozzle under great pressure.
It can easily puncture a person's skin.
Keep your hands away from the injection nozzle at all times.
- Do not use your fingers to feel for fuel leaks at fittings. Fuel pressure is high enough to penetrate the skin.
- Be careful when changing fuel system components: Diesel fuel is flammable. Be sure that the ignition key of OFF. Do not smoke or allow open flame in the area while changing fuel system components.

Illustration Arrows

Arrows help you to understand technical illustrations.

Arrow Type	Application
	Front of Engine
	Up
	Task Related
	View Detail
	View Angle
	Dimension (1:2)
	Sectioning (1:3)

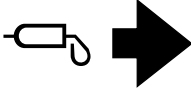
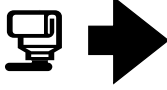
Arrow Type	Application
	<ul style="list-style-type: none"> • Ambient/Clean air flow • Cool air flow
	<ul style="list-style-type: none"> • Gas other than ambient air • Hot air flow
	<ul style="list-style-type: none"> • Ambient air mixed with another gas • Temperature change
	Direction
	Lubrication point (Oil or fluid)
	Lubrication point (Grease)
	Lubrication point (Jelly)

Abbreviations

List of abbreviations which may be used in this manual

A – Ampere(s)	lb in – Inch Pounds
AC – Alternating Current	LF – Left Front
ACL – Air Cleaner	LH – Left Hand
Adj – Adjust	LR – Left Rear
AMP – Ampere(s)	LS – Left Side
ASM – Assembly	L-4 – In-Line Four Cylinder Engine
ATDC – After Top Dead Center	Max – Maximum
Auto – Automatic	Min – Minimum
Bat – Battery	mm – Millimeter
B+ – Battery Positive Voltage	N – Newtons
BHP – Brake Horsepower	NA – Naturally Aspirated
BTDC – Before Top Dead Center	NC – Normally Closed
°C – Degrees Celsius	N·m – Newton Meters
cc – Cubic Centimeter	NO – Normally Open
CID – Cubic Inch Displacement	NOX – Nitrogen oxides
CO – Carbon Monoxide	OD – Outside Diameter
Conn – Connector	OHC – Overhead Camshaft
Crank – Crankshaft	PCV – Positive Crankcase Ventilation
Cu. In. – Cubic Inch	PRESS – Pressure
Cyl – Cylinder(s)	PROM – Programmable Read Only Memory
DOHC – Double Overhead Camshaft	psi – Pounds per Square Inch
DTC – Diagnostic Trouble Code	PSP – Power Steering Pressure
DTM – Diagnostic Test Mode	Pt. – Pint
DTT – Diagnostic Test Terminal	PWM – Pulse Width Modulate
ECM – Engine Control Module	Qt. – Quart
ECT – Engine Coolant Temperature	REF – Reference
EGR – Exhaust Gas Recirculation	RF – Right Front
Exh – Exhaust	RH – Right Hand
°F – Degrees Fahrenheit	RPM – Revolutions Per Minute
FL – Fusible Link	RPM Sensor – Engine Speed Sensor
FLW – Fusible Link Wire	RR – Right Rear
FP – Fuel Pump	RS – Right Side
FRT – Front	RTV –Room Temperature Vulcanizing
ft – Foot	SAE – Society of Automotive Engineers
Gal – Gallon	Sec – Secondary
GND – Ground	SI – System International
Gov – Governor	SOHC – Single Overhead Camshaft
g – Gram	Sol – Solenoid
Harn – Harness	SPEC – Specification
HC – Hydrocarbons	Speedo – Speedometer
HD – Heavy Duty	ST – Start / Scan Tool
Hg – Hydrargyrum (Mercury)	Sw – Switch
IC – Integrated Circuit / Ignition Control	SYN – Synchronize
ID – Identification / Inside Diameter	Tach – Tachometer
IGN – Ignition	TDC – Top Dead Center
INJ – Injection	Term – Terminal
Int – Intake	TEMP – Temperature
kg – Kilograms	TURBO – Turbocharger
km – Kilometers	V – Volt(s)
km/h – Kilometer per Hour	VAC – Vacuum
kPa – Kilopascals	V-ref – ECM Reference Voltage
kV – Kilovolts (thousands of volts)	VSS – Vehicle Speed Sensor
kW – Kilowatts	VSV – Vacuum Switch Valve
L – Liter	V-6 – Six Cylinder “Vee” Engine
lb ft – Foot Pounds	V-8 – Eight Cylinder “Vee” Engine
	W – Watt(s)
	w/ – With
	w/o – Without
	WOT – Wide Open Throttle

Nut and Bolt Angular Tightening Method

The angular tightening method uses the plastic region of high tensile steel nuts and bolts to precision tighten important engine fasteners.

Because of the method's nature, there is a limit to the number of times a particular fastener may be reused. This limit is specified in this Manual where applicable.

1. Carefully wash the nuts and bolts to remove all oil and grease.
2. Apply a coat of molybdenum disulfide grease to the threads and setting faces of the nuts and bolts.
3. Tighten the nuts and bolts to the specified torque (snug torque) with a torque wrench.
4. Draw a line (A)–(B) across the center of each nut or bolt.

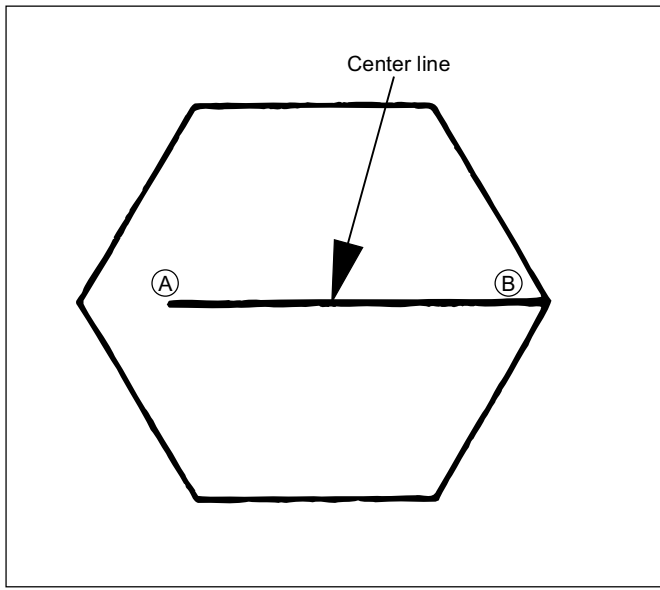

5. Draw another line (C) – (D) on the face of each of the parts to be clamped. This line should be an extension of the line (A) – (B).

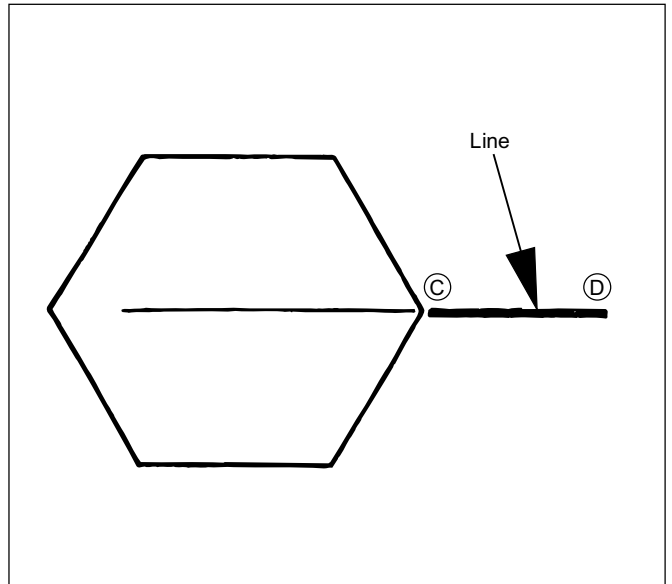

6. Draw another line (F) – (G) on the face of each of the parts to be clamped. This line will be in the direction of the specified angle (Q) across the center (E) of the nut or bolt.

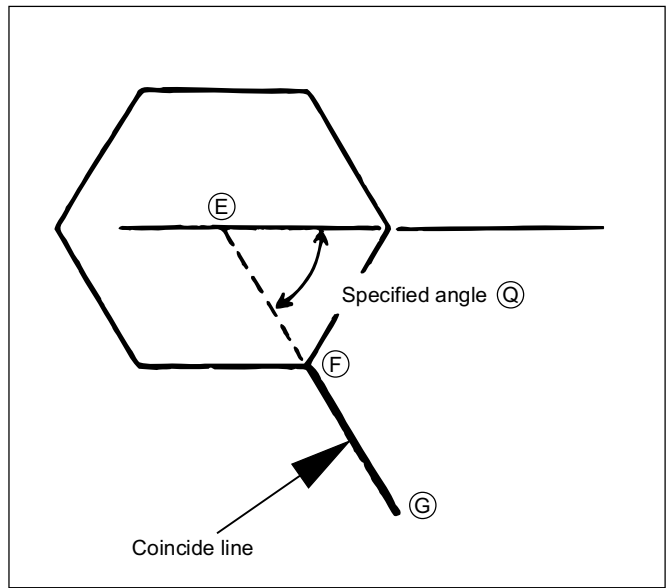

7. Use a socket wrench to tighten each nut or bolt to the point where the line (A) - (B) is aligned with the line (F) - (G).

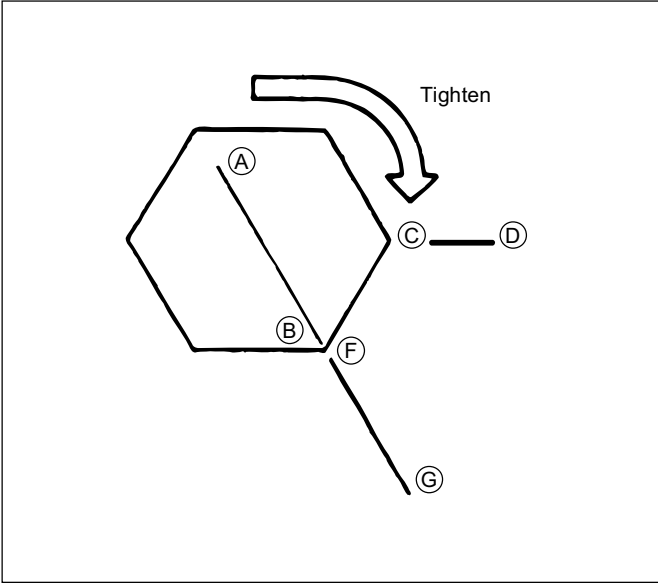

F00EY00005

Example: Specified Angle and Tightening Rotation

A	30°	1 / 12 of a turn
B	60°	1 / 6 of a turn
C	90°	1 / 4 of a turn
D	180°	1 / 2 of a turn
E	360°	One full turn

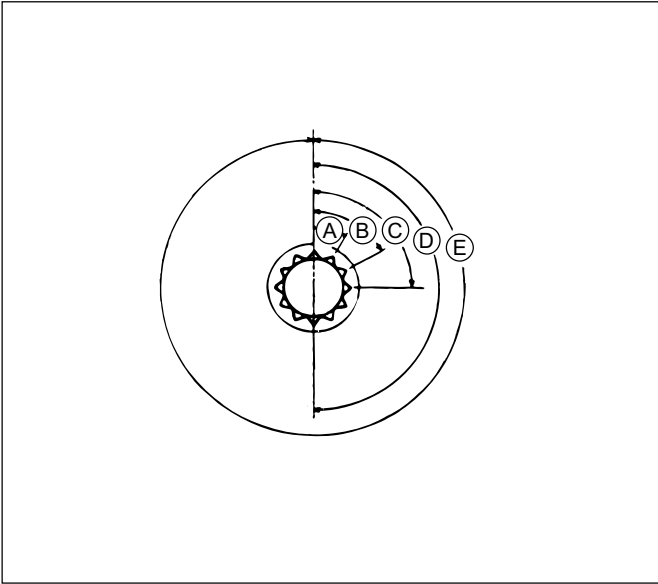









F00EY00004

Standard Bolt Torque Specifications

The tightening torque values given in the table below are applicable to all bolts unless otherwise specified.

STANDARD BOLT

N·m (kgf·m/lb.ft)



Bolt Identification Bolt Diameter × pitch (mm)				
				
M6 × 1.0	4 – 8 (0.4 – 0.8/3 – 6)	5 – 10 (0.5 – 1.0/4 – 7)		—————
M8 × 1.25	8 – 18 (0.8 – 1.8/6 – 13)	12 – 23 (1.2 – 2.3/9 – 17)		17 – 30 (1.7 – 3.1/12 – 22)
M10 × 1.25	21 – 34 (2.1 – 3.5/5 – 25)	28 – 46 (2.8 – 4.7/20 – 33)		37 – 62 (3.8 – 6.4/28 – 46)
* M10 × 1.5	20 – 33 (2.0 – 3.4/15 – 25)	28 – 45 (2.8 – 4.6/20 – 33)		36 – 60 (3.7 – 6.1/27 – 44)
M12 × 1.25	49 – 74 (5.0 – 7.5/36 – 54)	61 – 91 (6.2 – 9.3/45 – 67)		76 – 114 (7.7 – 11.6/56 – 84)
* M12 × 1.75	45 – 69 (4.6 – 7.0/33 – 51)	57 – 84 (5.8 – 8.6/42 – 62)		72 – 107 (7.3 – 10.9/53 – 79)
M14 × 1.5	77 – 115 (7.8 – 11.7/56 – 85)	93 – 139 (9.5 – 14.2/69 – 103)		114 – 171 (11.6 – 17.4/84 – 126)
* M14 × 2.0	72 – 107 (7.3 – 10.9/53 – 79)	88 – 131 (9.0 – 13.4/65 – 97)		107 – 160 (10.9 – 16.3/79 – 118)
M16 × 1.5	104 – 157 (10.6 – 16.0/77 – 116)	135 – 204 (13.8 – 20.8/100 – 150)		160 – 240 (16.3 – 24.5/118 – 177)
* M16 × 2.0	100 – 149 (10.2 – 15.2/74 – 110)	129 – 194 (13.2 – 19.8/96 – 143)		153 – 230 (15.6 – 23.4/113 – 169)
M18 × 1.5	151 – 226 (15.4 – 23.0/110 – 166)	195 – 293 (19.9 – 29.9/144 – 216)		230 – 345 (23.4 – 35.2/169 – 255)
* M18 × 2.5	151 – 226 (15.4 – 23.0/110 – 166)	196 – 294 (20.0 – 30.0/145 – 217)		231 – 346 (23.6 – 35.5/171 – 255)
M20 × 1.5	206 – 310 (21.0 – 31.6/152 – 229)	270 – 405 (27.5 – 41.3/199 – 299)		317 – 476 (32.3 – 48.5/234 – 351)
* M20 × 2.5	190 – 286 (19.4 – 29.2/140 – 211)	249 – 375 (25.4 – 38.2/184 – 276)		293 – 440 (29.9 – 44.9/216 – 325)
M22 × 1.5	251 – 414 (25.6 – 42.2/185 – 305)	363 – 544 (37.0 – 55.5/268 – 401)		425 – 637 (43.3 – 64.9/313 – 469)
* M22 × 2.5	218 – 328 (22.2 – 23.4/161 – 242)	338 – 507 (34.5 – 51.7/250 – 374)		394 – 592 (40.2 – 60.4/291 – 437)
M24 × 2.0	359 – 540 (36.6 – 55.0/265 – 398)	431 – 711 (43.9 – 72.5/318 – 524)		554 – 831 (56.5 – 84.7/409 – 613)
* M24 × 3.0	338 – 507 (34.5 – 51.7/250 – 374)	406 – 608 (41.4 – 62.0/299 – 448)		521 – 782 (53.1 – 79.7/384 – 576)

An asterisk (*) indicates that the bolts are used for female threaded parts that are made of soft materials such as casting.

The tightening torque values given in the table below are applicable to all bolts unless otherwise specified.

FLANGED HEAD BOLT

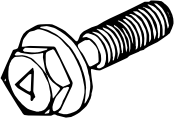
N·m (kgf·m/lb.ft)

Bolt Identification Bolt Diameter × pitch (mm)			
M6 × 1.0	5 – 9 (0.5 – 0.9/4 – 7)	6 – 12 (0.6 – 1.2/4 – 9)	—————
M8 × 1.25	11 – 20 (1.1 – 2.0/8 – 15)	15 – 28 (1.6 – 2.9/12 – 21)	18 – 34 (2.1 – 3.4/15 – 25)
M10 × 1.25	23 – 39 (2.4 – 3.9/17 – 28)	35 – 59 (3.6 – 6.1/26 – 44)	42 – 71 (4.3 – 7.2/31 – 52)
* M10 × 1.5	22 – 37 (2.3 – 3.8/17 – 28)	35 – 58 (3.5 – 5.8/25 – 42)	40 – 67 (4.1 – 6.8/30 – 49)
M12 × 1.25	55 – 82 (5.6 – 8.4/40 – 61)	77 – 117 (7.9 – 11.9/57 – 86)	85 – 128 (8.7 – 13.0/63 – 94)
* M12 × 1.75	51 – 77 (5.2 – 7.8/38 – 56)	71 – 107 (7.3 – 10.9/53 – 79)	80 – 119 (8.1 – 12.2/59 – 88)
M14 × 1.5	83 – 125 (8.5 – 12.7/62 – 92)	115 – 172 (11.7 – 17.6/85 – 127)	123 – 185 (12.6 – 18.9/91 – 137)
* M14 × 2.0	77 – 116 (7.9 – 11.8/57 – 85)	108 – 162 (11.1 – 16.6/80 – 120)	116 – 173 (11.8 – 17.7/85 – 128)
M16 × 1.5	116 – 173 (11.8 – 17.7/85 – 128)	171 – 257 (17.4 – 26.2/126 – 190)	177 – 265 (18.0 – 17.1/130 – 196)
* M16 × 2.0	109 – 164 (11.2 – 16.7/81 – 121)	163 – 244 (16.6 – 24.9/120 – 180)	169 – 253 (17.2 – 25.8/124 – 187)

A bolt with an asterisk (*) is used for female screws that are made of soft materials such as cast iron.

Recommended Thread Locking Agents

LOCTITE Type	LOCTITE Color
LOCTITE 242	Blue
LOCTITE 262	Red
LOCTITE 271	Red

Application Steps

1. Completely remove all lubricant and moisture from the bolts and the female-threaded surfaces of the parts to be joined.

The surfaces must be perfectly dry.

2. Apply LOCTITE to the bolts.

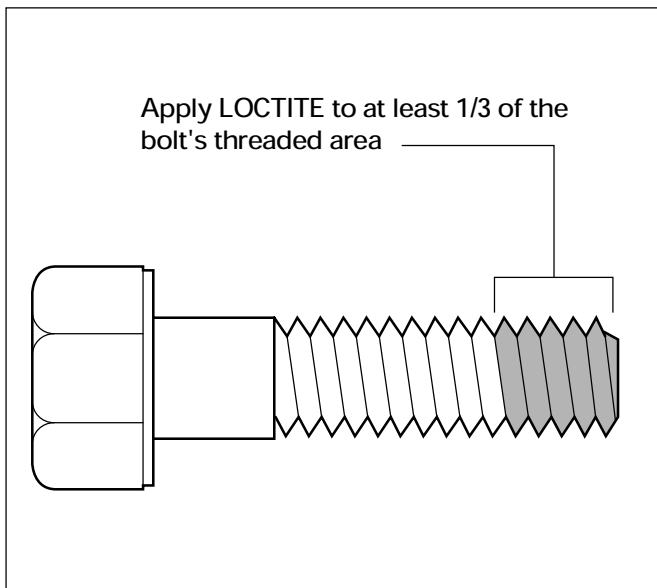

F00RW014

3. Tighten the bolts to the specified torque.

After tightening, be sure to keep the bolts free from vibration and torque for at least an hour until the LOCTITE hardens.

NOTE: When the application procedures are specified in this manual, follow them.

0A-10 GENERAL INFORMATION

ITEMS	6HK1
Relief valve opening pressure kPa (kg/cm ² /psi)	780 (8.0/114)
Oil pressure switch operating pressure* kPa (kg/cm ² /psi)	29 (0.3/4)
Main oil filter	Paper element
Bypass valve opening pressure kPa (kg/cm ² /psi)	200 (2.0/28.4)
Oil volume* L (qts)	36 (38) with combined main and partial oil filter
Oil cooler	Plate type – Water cooled in water jacket
Cooling system	Pressured compulsory circulation water
Coolant volume L (qts)	14.5 (15.3)
Water pump	Centrifugal impeller
Delivery volume Lit/min. (Imp. gal/US gal)	167 (37/44) Pump speed a 1,600 min ⁻¹
Thermostat	Wax pellet
Valve initial opening temperature* °C (°F)	82 (180)
Valve lift mm (in)	10 (0.39)
Air cleaner	
Alternator capacity* V – A	24 – 50
Regulator*	IC (Built-in)
Brush length* mm (in)	Brushless
Starter motor output* V – kW	24 – 5
Number of poles*	4
Turbocharger model*	RHG 6
Manufacturer	Ishikawajima-Harima Heavy Industries (IHI)

Specifications for items marked with an asterisk (*) may vary according to the type of equipment on which the engine is installed.

ENGINE EXTERNAL VIEW DRAWING
MODEL AA-6HK1

Note:
Engine details may vary depending
on the specifications.

-
-
-
-
-
-
-
-

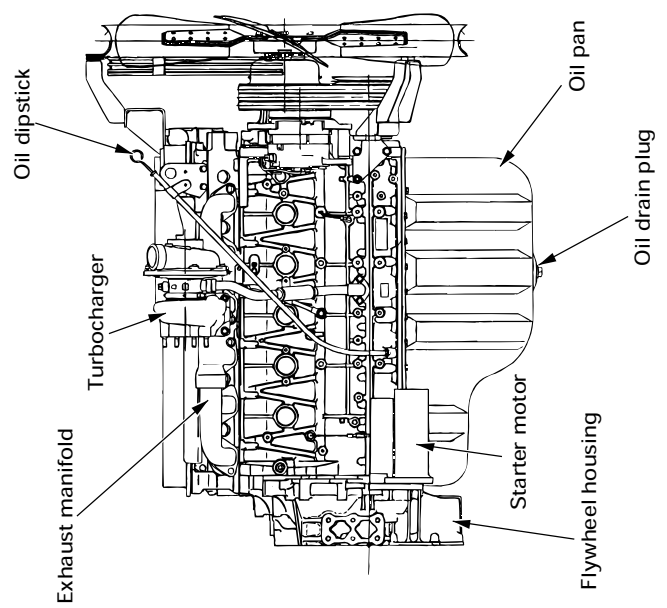
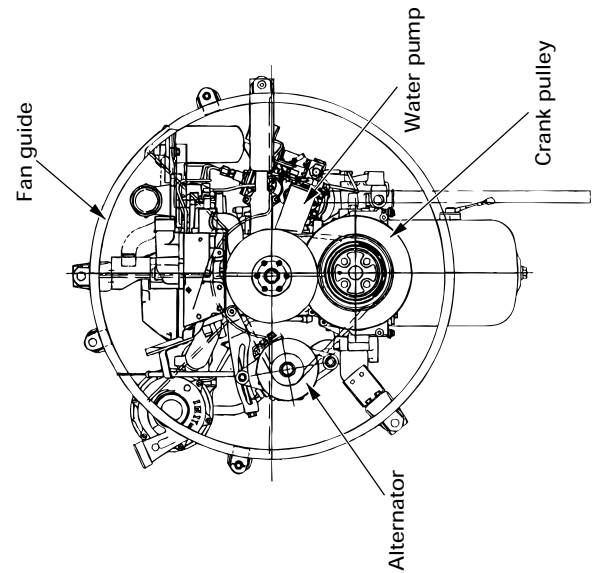
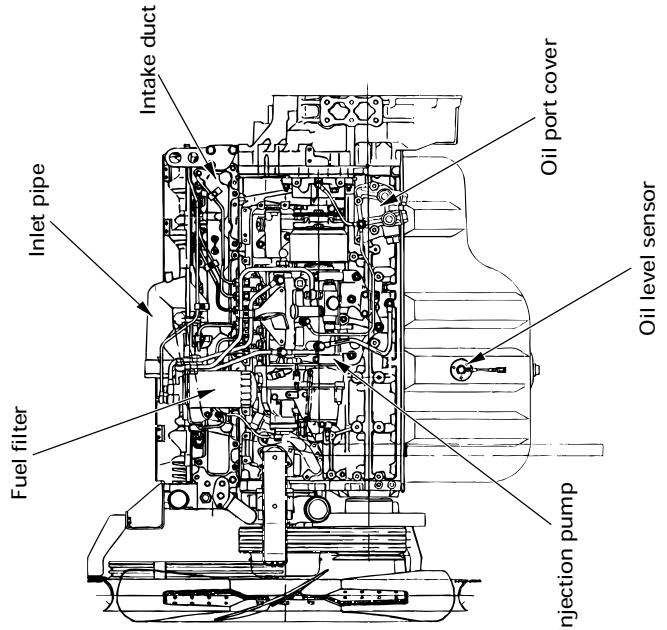
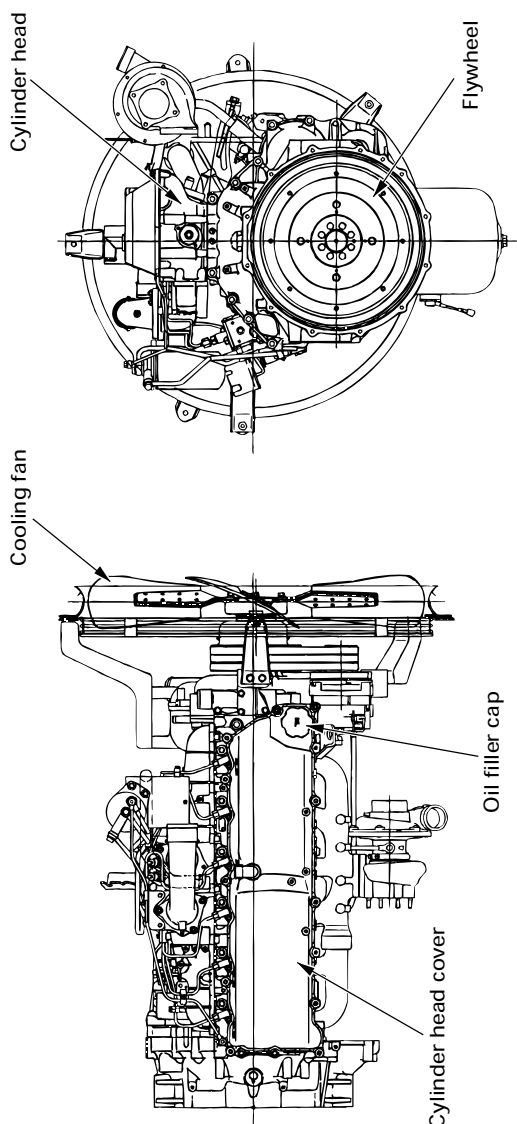

Buy Now



Our support email:

ebooklibonline@outlook.com