

JD24A and 125 Skid-Steer Loaders



JOHN DEERE

OPERATORS MANUAL

JD24A and 125 Skid-Steer
Loaders

OMM77699 A8 English

John Deere
Lawn & Grounds Care Division
OMM77699 A8

LITHO IN U.S.A.
ENGLISH



Contents

	<i>Page</i>		<i>Page</i>
Safety	1	Transporting	37
Controls	9	Service	38
Operating the Engine	11	Storage	61
Operating the Loader	14	Specifications	63
Fuels and Lubricants	27		
Troubleshooting	30		

Safety

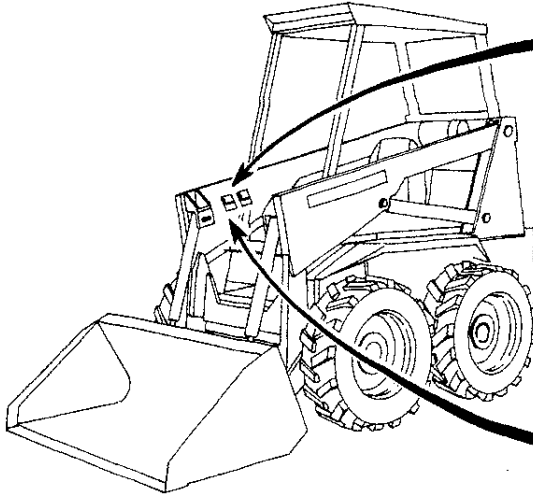

⚠ WARNING

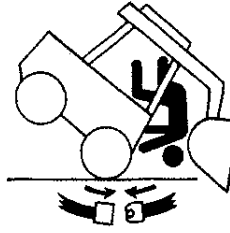

AVOID INJURY

- Loader can move suddenly and violently
- Always wear seat belt

⚠ DANGER

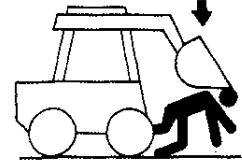

AVOID DEATH

- Before removing seat belt and leaving seat
- Lower lift arms to ground or rest lift arms on stops
 - Stop engine
 - Bumping foot pedal can cause lift arms to fall

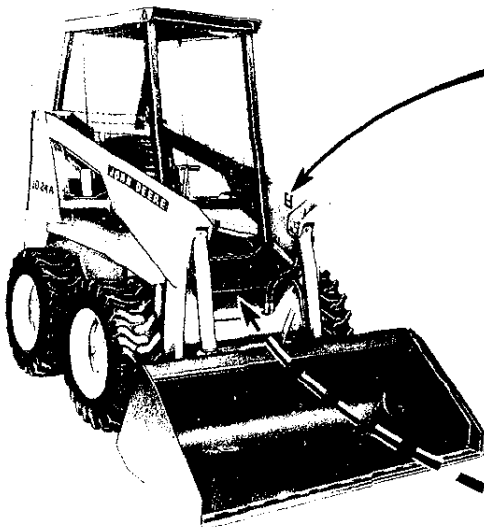

⚠ DANGER



CRUSHING BY LIFT ARMS

- Do not reach over wheels and push pedals at same time
- Secure and lock raised lift arms
- Install Rollover Protective Structure (ROPS) with side screens

⚠ DANGER

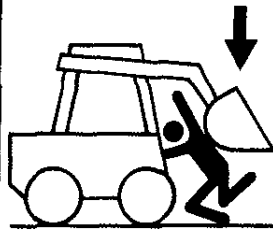

AVOID DEATH

- Secure and lock lift arms before cleaning or servicing

M60080 040288

⚠ CAUTION

- 1 Read operator's manual before operating this machine.
- 2 Do not work under lift arms unless lift arm stops are engaged. Always engage lift arm stops if for any reason it is necessary to leave lift arms raised.
- 3 Do not operate unless ROPS side screens and safety shields are in place.
- 4 Do not mount or dismount this machine unless engine is shut off, bucket is lowered to the ground and parking brake is engaged.
- 5 Operate only from the operator's seat. Always fasten seat belt.
- 6 Do not start engine unless parking brake is set and steering and hydraulic controls are in neutral.
- 7 Load free falls when lift arms control pedal is fully depressed. Make sure area under lift arms is clear and be alert.
- 8 Never make sharp maneuvers with lift arms in raised position. Carry load low.
- 9 Travel slowly over rough terrain.
- 10 Level bucket as lift arms are raised to prevent spill into operator's compartment.
- 11 Never allow riders.
- 12 Do not tow to start engine or transport vehicle.

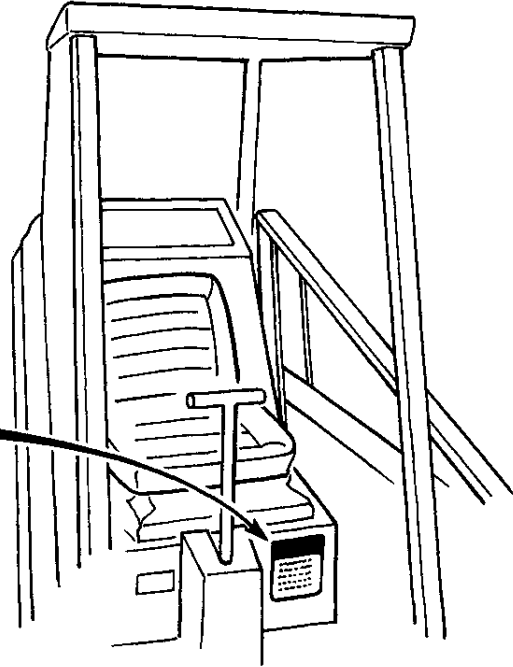

⚠ CAUTION Carry Load Low

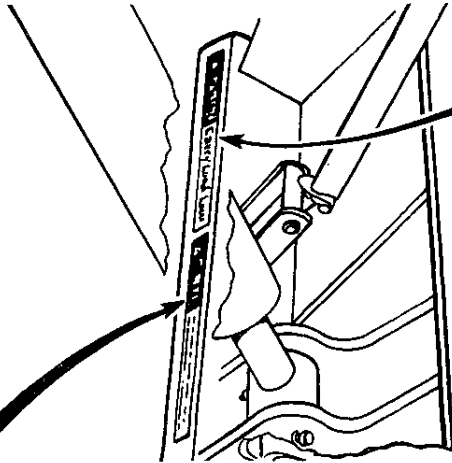

⚠ WARNING

To avoid bodily injury from fall of raised lift arms, extend safety stops before walking or working under lift arms.

M60079 040288

RECOGNIZE SAFETY INFORMATION

This is the safety-alert symbol. When you see this symbol on your machine or in this manual, be alert to the potential for personal injury.

Follow recommended precautions and safe operating practices.



AB6:T81389 053;ALERT 160687

UNDERSTAND SIGNAL WORDS

A signal word—DANGER, WARNING, or CAUTION—is used with the safety-alert symbol. DANGER identifies the most serious hazards.

Safety signs with signal word DANGER or WARNING are typically near specific hazards.

General precautions are listed on CAUTION safety signs. CAUTION also calls attention to safety messages in this manual.



AB6:TS187 053;SIGNAL 071085

FOLLOW SAFETY INSTRUCTIONS

Carefully read all safety messages in this manual and on your machine safety signs. Keep safety signs in good condition. Replace missing or damaged safety signs.

Learn how to operate the machine and how to use controls properly. Do not let anyone operate without instruction.

Keep your machine in proper working condition. Unauthorized modifications to the machine may impair the function and/or safety and affect machine life.

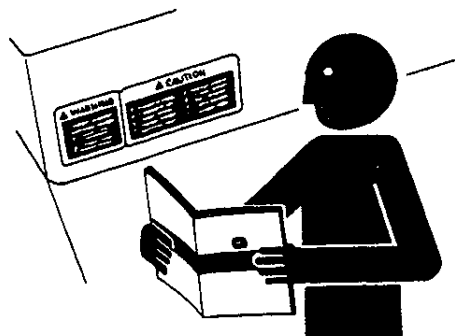

AB6:TS201 053;READ 230487

USE SEAT BELT PROPERLY

Use a seat belt when you operate with a roll-over protective structure (ROPS) to minimize chance of injury from an accident such as an overturn.

Do not use a seat belt if operating without a ROPS.

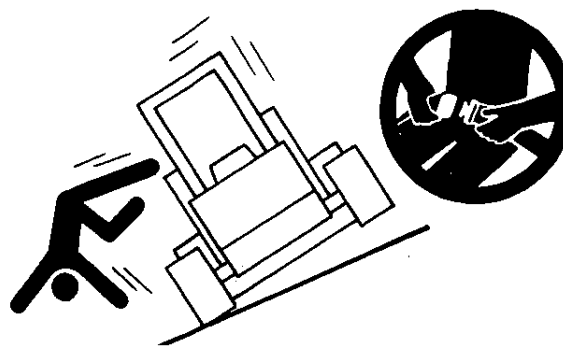

M6007 AA5 040288

OPERATE LOADER WITH CAUTION

Check location of cables, gas lines, and water mains before digging.

Keep loading area smooth.

Never lower a loaded bucket with the boom and bucket control lever in the float position. Keep load within SAE load limit.

Increase the power gradually when pulling a heavy load or when driving out of a ditch or excavation.

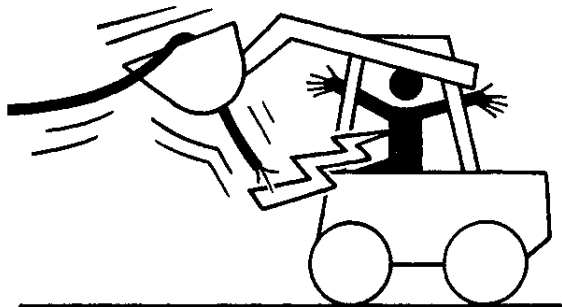

M60021 AA6 040288

USE A SAFETY CHAIN

A safety chain will help control drawn equipment should it accidentally separate from the drawbar.

Using the appropriate adapter parts, attach the chain to the loader drawbar support or other specified anchor location. Provide only enough slack in the chain to permit turning.

See your John Deere dealer for a chain with a strength rating equal to or greater than the gross weight of the towed machine. Do not use safety chain for towing.

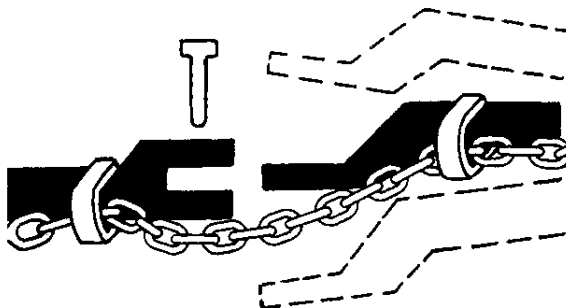

AB6;TS217 053;CHAIN 171287

INSPECT MACHINE

Inspect your machine carefully each day by walking around it before you start it.



018;T6607AQ T82;BHS CL. 060188

USE HANDHOLDS AND STEPS

Maintain a three point contact with steps and handrails and face machine when getting on or off machine. Do not use controls as hand holds.

Never jump on or off machine or dismount a moving machine.

Be careful of slippery platforms, steps, and handrails.

Lower bucket to ground, apply brake, and stop engine before dismounting.

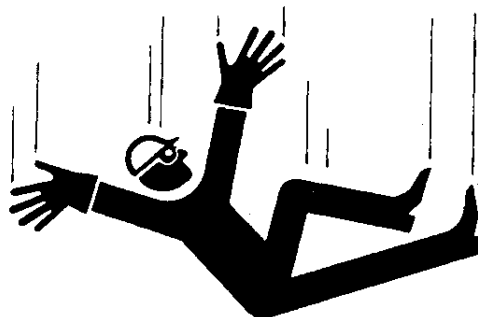

T6607AP AA9 040288

PREPARE FOR EMERGENCIES

Be prepared if a fire starts.

Keep a first aid kit and fire extinguisher handy.

Keep emergency numbers for doctors, ambulance service, hospital, and fire department near your telephone.

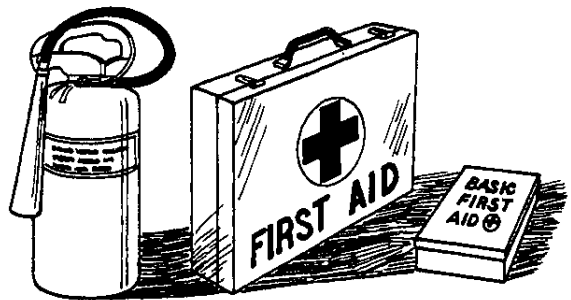

AB6;TS186 053;FIRE2 080785

HANDLE FUEL SAFELY—AVOID FIRES

Handle fuel with care: it is highly flammable. Do not refuel the machine while smoking or when near open flame or sparks.

Always stop engine before refueling machine. Fill fuel tank outdoors.

Prevent fires by keeping machine clean of accumulated trash, grease, and debris. Always clean up spilled fuel.



AB6;TS202 053;FIRE1 230487

PROTECT CHILDREN

Keep children and others away when you operate machine.

Before you back up or turn, look behind and around skid steer loader for children.

Do not let children operate loader.

Do not let children ride on loader or any attachment.

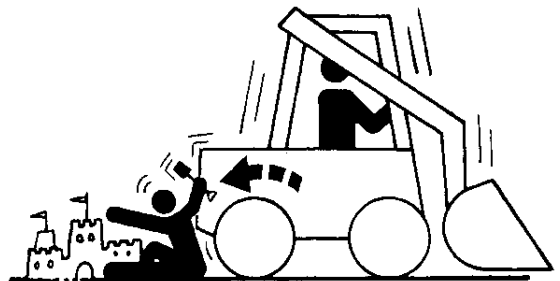

M60008 AA12 040288

REMEMBER THE OTHER GUY

Never use a bucket or attachment for a work platform or personnel carrier.

Never move loads over the heads of other persons.

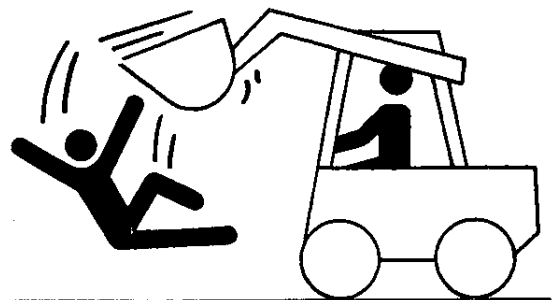

M60009 AA13 040288

KEEP RIDERS OFF MACHINE

Only allow the operator on the machine. Keep riders off.

Riders on machine are subject to injury such as being struck by foreign objects and being thrown off of the machine. Riders also obstruct the operator's view resulting in the machine being operated in an unsafe manner.

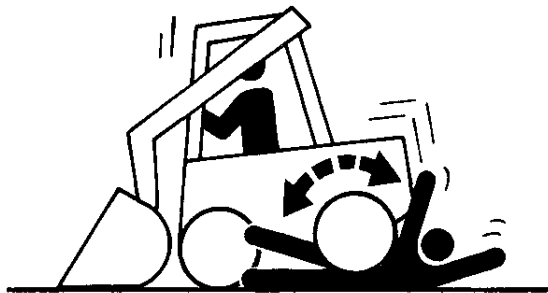

M60010 AA14 040288

WEAR PROTECTIVE CLOTHING

Wear close fitting clothing and safety equipment appropriate to the job.

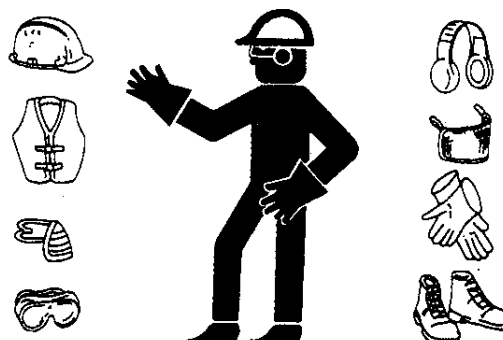

AB6;TS206 053;WEAR2 230487

PROTECT AGAINST NOISE

Prolonged exposure to loud noise can cause impairment or loss of hearing.

Wear a suitable hearing protective device such as earmuffs or earplugs to protect against objectionable or uncomfortable loud noises.



AB6;TS207 053;NOISE 230487

BEWARE OF EXHAUST FUMES

Prevent asphyxiation. Engine exhaust fumes can cause sickness or death.

If you must operate in a building, be positive there is adequate ventilation. Either use an exhaust pipe extension to remove the exhaust fumes or open doors and windows to bring enough outside air into the area.

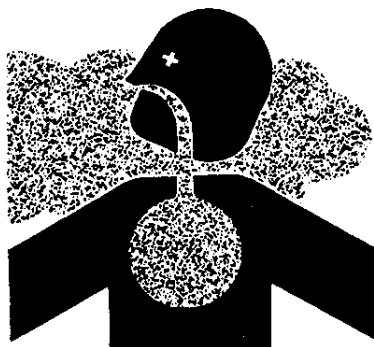

018;T6458AQ 02T;05 J9 151286

PREVENT MACHINE RUNAWAY

Avoid possible injury or death from machinery runaway.

Do not start engine by shorting across starter terminals. Machine will start in gear if normal circuitry is bypassed.

NEVER start engine while standing on ground. Start engine only from operator's seat, with transmission in neutral or park.



M60010 AA18 040288

PRACTICE SAFE MAINTENANCE

Never service moving machine. Keep away from driven parts. Disengage power and operate controls to release pressure. Lower equipment to ground.

Support equipment that must be raised to service.

Keep parts in good condition and properly installed. Remove grease, oil, and debris.



M60075 AA19 040288

CLEAN THE MACHINE REGULARLY

Remove any grease, oil or debris build-up to avoid possible injury or machine damage.

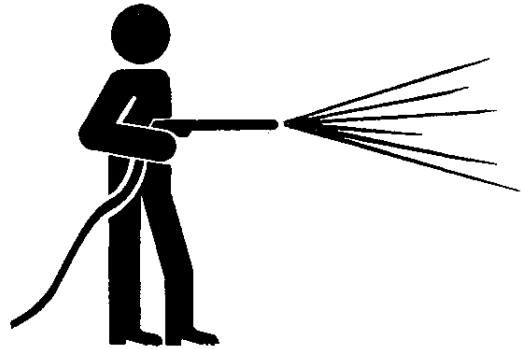

018:T6642EJ T82:FLSA AC 050188

SERVICE COOLING SYSTEM SAFELY

⚠ CAUTION: Wait for engine to cool before releasing pressure in radiator cap. Loosen cap slowly to the stop.



018:T6642EK 02T:05 K45 020987

AVOID HIGH-PRESSURE FLUIDS

Escaping fluid under pressure can penetrate the skin causing serious injury. Relieve pressure before disconnecting hydraulic or other lines. Tighten all connections before applying pressure. Keep hands and body away from pinholes and nozzles which eject fluids under high pressure. Use a piece of cardboard to search for leaks.

If ANY fluid is injected into the skin, it must be surgically removed within a few hours by a doctor familiar with this type injury or gangrene may result.

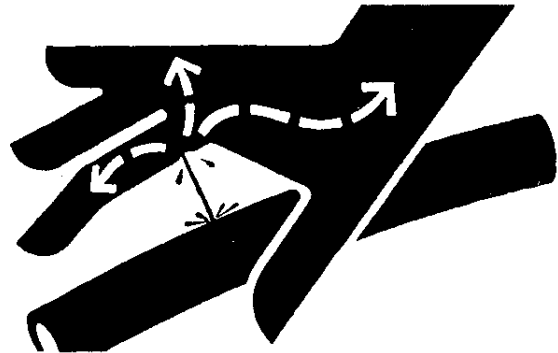

AB6:X9811 053;FLUID 180987

BATTERY EXPLOSION

CAUTION: Battery gas can explode. Keep sparks and flames away from batteries.

Use a voltmeter or hydrometer only to check battery charge.

Remove ground (-) clamp first and install last. If a metal object touches ungrounded post and chassis at the same time a dangerous spark will result.

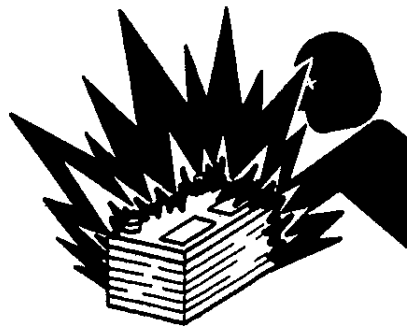

M60076 AA23 040288

ACID BURNS

CAUTION: Sulfuric acid in battery is poisonous. It will burn skin, eat holes in clothing, and cause blindness. Wear eye protection and rubber gloves when filling batteries. Avoid breathing fumes.

Wash acid spills from skin and eyes. If swallowed, drink large amounts of water or milk. Then drink milk of magnesia, beaten eggs, or vegetable oil. Get medical attention immediately.

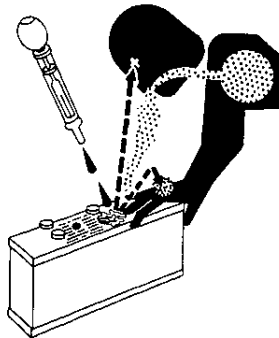

M60077 AA24 040288

CHECK TIRE PRESSURE

CAUTION: Explosive separation of tire and rim can cause serious injury or death.

Have your John Deere dealer or qualified repair service mount tires.

Maintain correct pressure. Use a clip-on chuck and extension hose to allow you to stand to one side. Inspect tires and wheels daily.

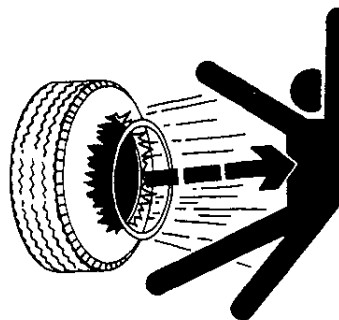

M60078 AA25 040288

Controls

HAND CONTROLS

- A—Seat Adjustment Lever
- B—Throttle
- C—T-Bar Control Handle
- D—Parking Brake
- E—Seat Belt
- F—Choke (Gas) Air Shut-Off (Diesel)

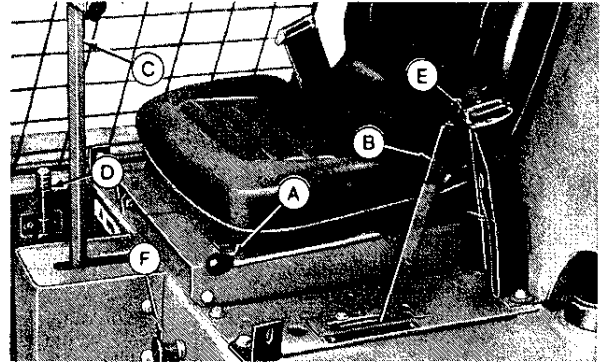

M60029 AA26 040288

FOOT CONTROLS

- A—Lift Arm Control
- B—Bucket Tilt Control

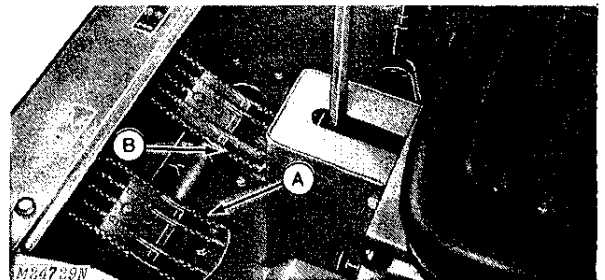

M60030 AA27 040288

INSTRUMENT PANEL AND INDICATOR LIGHTS

- A—Alternator Ammeter
- B—Fuel Gauge
- C—Engine Coolant Temperature Gauge
- D—Oil Pressure Gauge
- E—Hydraulic Vacuum Gauge
- F—Hour Meter
- G—Flashing Light Switch
- H—Head and Tail Light Switch
- I—Key Switch
- J—Glow Plug Indicator
- K—Flasher Switch
- L—Glow Plug Indicator
- M—Light Switch
- N—Hour Meter
- O—Fuel Gauge
- P—Ignition Switch
- Q—Engine Temperature
- R—Oil Pressure Light
- S—Ammeter Light

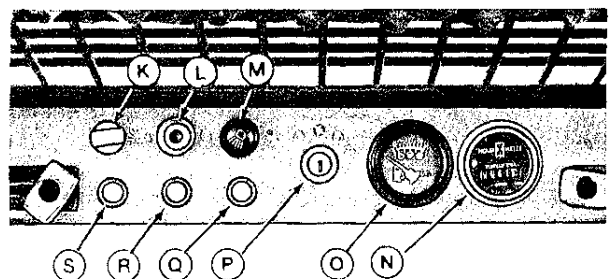
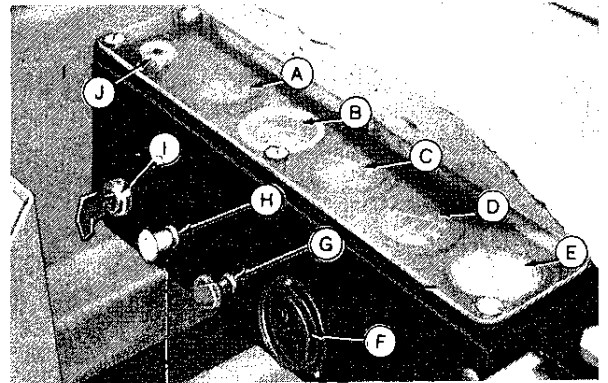

M60031, M60081 AA28 040288

Thank you so much for reading.
Please click the “Buy Now!”
button below to download the
complete manual.



After you pay.

You can download the most
perfect and complete manual in
the world immediately.

Our support email:

ebooklibonline@outlook.com