

JD24A and 125 Skid-Steer Loaders



JOHN DEERE

OPERATORS MANUAL

JD24A and 125 Skid-Steer
Loaders

OMM77699 A8 English

John Deere
Lawn & Grounds Care Division
OMM77699 A8

LITHO IN U.S.A.
ENGLISH



Contents

	<i>Page</i>		<i>Page</i>
Safety	1	Transporting	37
Controls	9	Service	38
Operating the Engine	11	Storage	61
Operating the Loader	14	Specifications	63
Fuels and Lubricants	27		
Troubleshooting	30		

Safety

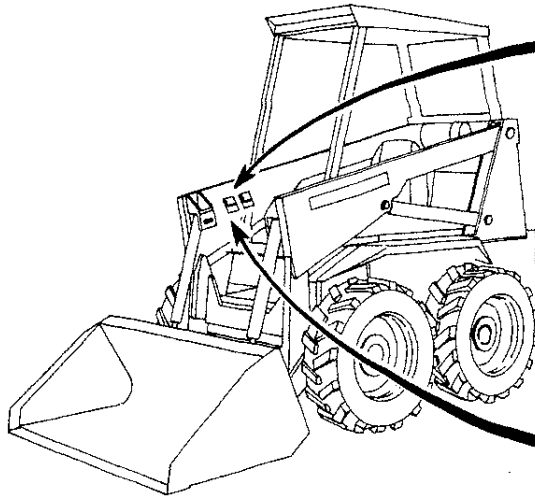

⚠ WARNING

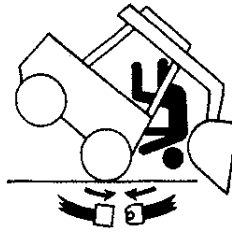

AVOID INJURY

- Loader can move suddenly and violently
- Always wear seat belt

⚠ DANGER

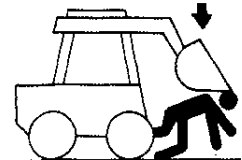

AVOID DEATH

- Before removing seat belt and leaving seat
- Lower lift arms to ground or rest lift arms on stops
 - Stop engine
 - Bumping foot pedal can cause lift arms to fall

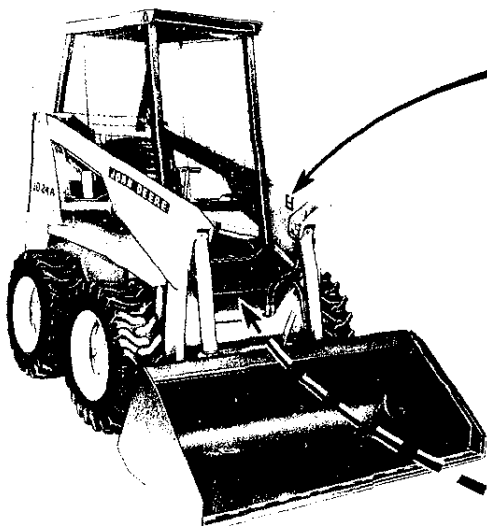

⚠ DANGER



CRUSHING BY LIFT ARMS

- Do not reach over wheels and push pedals at same time
- Secure and lock raised lift arms
- Install Rollover Protective Structure (ROPS) with side screens

⚠ DANGER

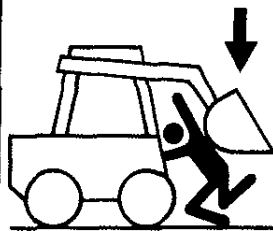

AVOID DEATH

- Secure and lock lift arms before cleaning or servicing

M60080 040288

⚠ CAUTION

- 1 Read operator's manual before operating this machine.
- 2 Do not work under lift arms unless lift arm stops are engaged. Always engage lift arm stops if for any reason it is necessary to leave lift arms raised.
- 3 Do not operate unless ROPS side screens and safety shields are in place.
- 4 Do not mount or dismount this machine unless engine is shut off, bucket is lowered to the ground and parking brake is engaged.
- 5 Operate only from the operator's seat. Always fasten seat belt.
- 6 Do not start engine unless parking brake is set and steering and hydraulic controls are in neutral.
- 7 Load free falls when lift arms control pedal is fully depressed. Make sure area under lift arms is clear and be alert.
- 8 Never make sharp maneuvers with lift arms in raised position. Carry load low.
- 9 Travel slowly over rough terrain.
- 10 Level bucket as lift arms are raised to prevent spill into operator's compartment.
- 11 Never allow riders.
- 12 Do not tow to start engine or transport vehicle.

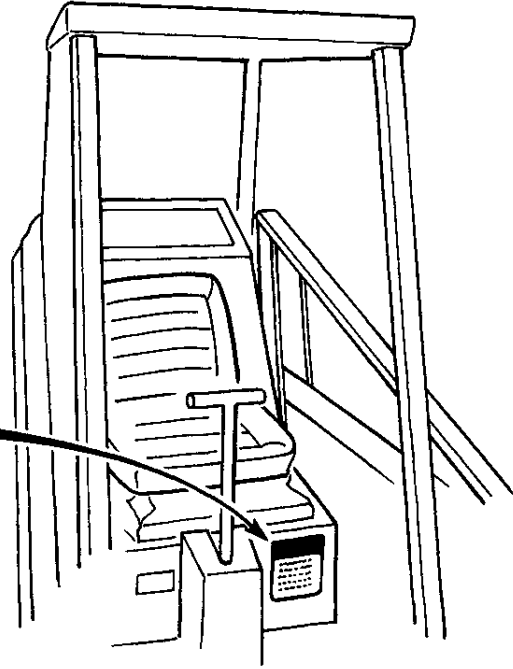

⚠ CAUTION Carry Load Low

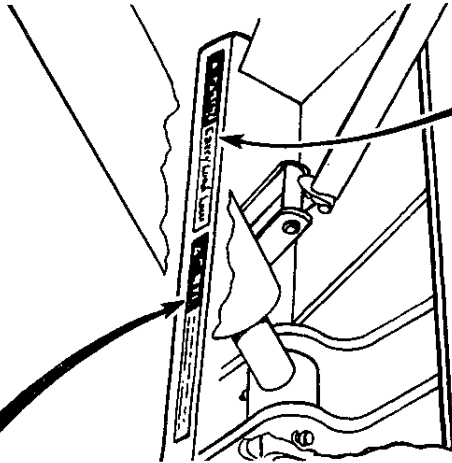

⚠ WARNING

To avoid bodily injury from fall of raised lift arms, extend safety stops before walking or working under lift arms.

RECOGNIZE SAFETY INFORMATION

This is the safety-alert symbol. When you see this symbol on your machine or in this manual, be alert to the potential for personal injury.

Follow recommended precautions and safe operating practices.



AB6:T81389 053;ALERT 160687

UNDERSTAND SIGNAL WORDS

A signal word—DANGER, WARNING, or CAUTION—is used with the safety-alert symbol. DANGER identifies the most serious hazards.

Safety signs with signal word DANGER or WARNING are typically near specific hazards.

General precautions are listed on CAUTION safety signs. CAUTION also calls attention to safety messages in this manual.



AB6:TS187 053;SIGNAL 071085

FOLLOW SAFETY INSTRUCTIONS

Carefully read all safety messages in this manual and on your machine safety signs. Keep safety signs in good condition. Replace missing or damaged safety signs.

Learn how to operate the machine and how to use controls properly. Do not let anyone operate without instruction.

Keep your machine in proper working condition. Unauthorized modifications to the machine may impair the function and/or safety and affect machine life.

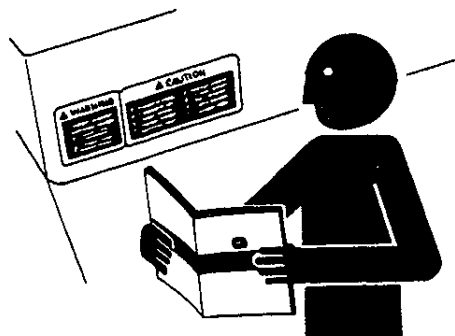

AB6:TS201 053;READ 230487

USE SEAT BELT PROPERLY

Use a seat belt when you operate with a roll-over protective structure (ROPS) to minimize chance of injury from an accident such as an overturn.

Do not use a seat belt if operating without a ROPS.

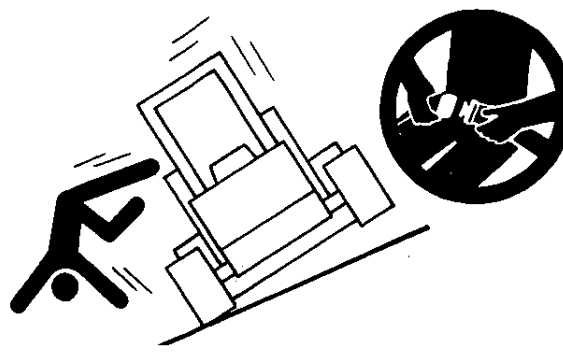

M6007 AA5 040288

Thank you so much for reading.
Please click the “Buy Now!”
button below to download the
complete manual.



After you pay.

You can download the most
perfect and complete manual in
the world immediately.

Our support email:

ebooklibonline@outlook.com