

JOHN DEERE
WORLDWIDE COMMERCIAL & CONSUMER
EQUIPMENT DIVISION

Sprayer Attachment for ProGator
HD200

OMTCU19538 G7

OPERATOR'S MANUAL



JOHN DEERE

All information, illustrations and specifications in this manual are based on the latest information at the time of publication. The right is reserved to make changes at any time without notice.

COPYRIGHT© 2007
Deere & Co.

John Deere Worldwide Commercial and Consumer Equipment Division

All rights reserved
Previous Editions

COPYRIGHT© 1999, 2003, 2004, 2006

Export Version
Litho in U.S.A.

INTRODUCTION

Introduction

Using Your Operator's Manual

Read this entire operator's manual, especially the safety information, before operating.

This manual is an important part of your machine. Keep all manuals in a convenient location so they can be accessed easily.

Use the safety and operating information in the attachment operator's manual, along with the machine operator's manual, to operate and service the attachment safely and correctly.

If your attachment manual has a section called Preparing the Machine, it means that you will have to do something to your tractor or vehicle before you can install the attachment. The Assembly and Installation sections of this manual provide information to assemble and install the attachment to your tractor or vehicle. Use the Service section to make any needed adjustments and routine service to your attachment.

If you have any questions or concerns with the assembly, installation, or operation of this attachment, see your local John Deere dealer or call the John Deere Customer Contact Center at 1-800-537-8233 for assistance.

Warranty information on this John Deere attachment can be found in the warranty that came with your John Deere tractor or vehicle.

Machine Use

This machine is designed solely for use in customary lawn and turf spraying operations. Use in any other way is considered as contrary to the intended use.

Agricultural applications covered by national environmental protection standards or legal requirements are not allowed with this sprayer. Contact local authorities if the acceptance for the use of the sprayer is not obvious.

The manufacturer accepts no liability for damage or injury resulting from this misuse, and these risks must be borne solely by the user. Compliance with and strict adherence to the conditions of operation, service and repair as specified by the manufacturer also constitute essential elements for the intended use.

This machine should be operated, serviced and repaired only by persons familiar with all its particular characteristics and acquainted with the relevant safety rules (accident prevention). The accident prevention regulations, all other generally recognized regulations on safety and occupational medicine and the road traffic regulations must be observed at all times.

Setting fuel delivery beyond published factory specifications or otherwise overpowering will result in loss of warranty protection for this machine.

Any arbitrary modifications carried out on this machine will relieve the manufacturer of all liability for any resulting damage or injury.

Product Identification

Product Compatibility

The HD200 Sprayer Attachment is compatible with PROGATOR™ utility vehicles.

Record Identification Numbers

Sprayer Attachment

HD200 Serial Number - (035101 -)

If you need to contact an Authorized Service Center for information on servicing, always provide the product model and serial number.

You will need to locate the model and serial number for the sprayer attachment and record the information in the spaces provided below.

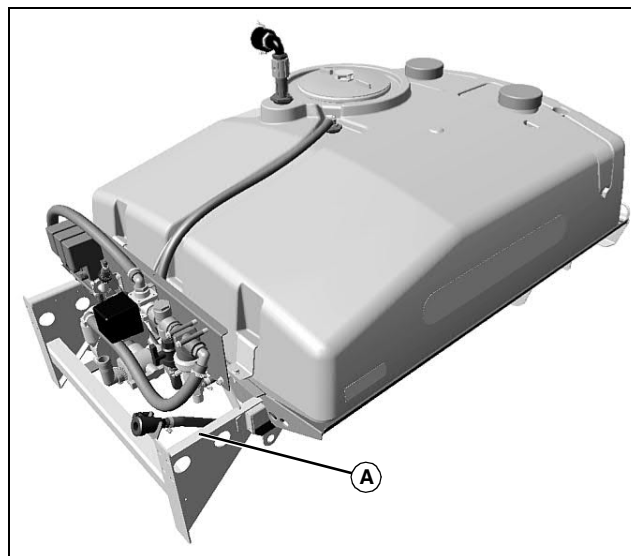

MX19912

DATE OF PURCHASE:

DEALER NAME:

DEALER PHONE:

PRODUCT SERIAL NUMBER (A):

Safety Labels



Pictorial Safety Signs

At several important places on this machine safety signs are affixed intended to signify potential danger. The hazard is identified by a pictorial in a warning triangle. An adjacent pictorial provides information how to avoid personal injury.

These safety signs, their placement on the machine and a brief explanatory text are shown in this Safety section.

Avoid Injury Read Operator's Manual

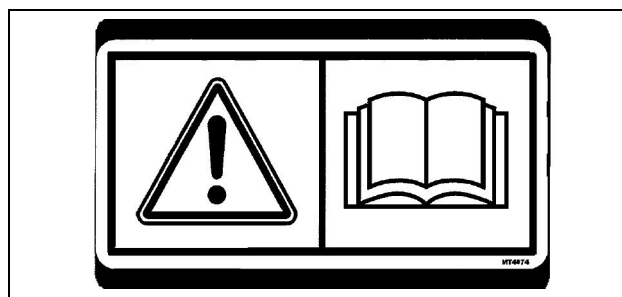

MT4074

- Empty tank before removing attachment.
- Winterize system when finished each day when operating in near freezing conditions.
- Check system is at 0 PSI (0 kPa) before starting.

SAFETY

Danger - Avoid Injury from Contaminated Water

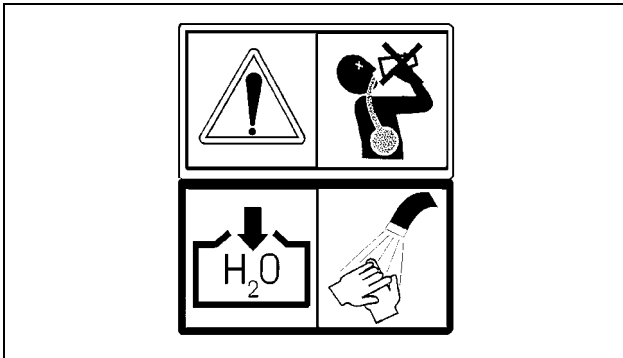

MT4295

- To avoid injury, do not drink water from this container. It may be contaminated. Use for rinse/wash purposes only.

Warning - Avoid Injury from Chemical Hazards

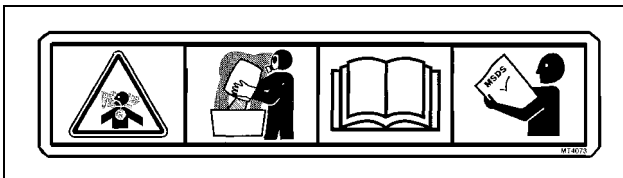

MT4072

- To avoid injury from chemical hazards, wear protective clothing. Read and follow chemical manufacturer's labels and instructions.

Read Operator's Manual

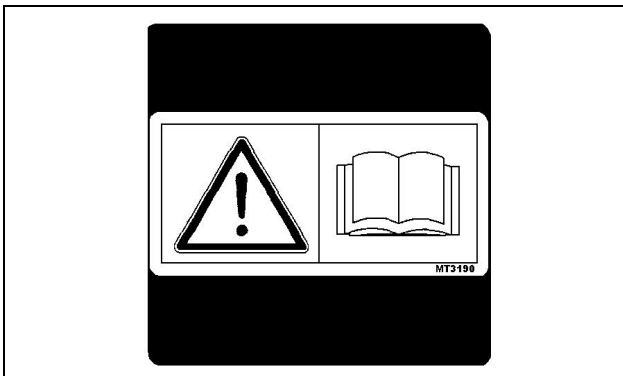

MT3190

- To avoid injury, read operator's manual.
- Ballast power unit per operator's manual.
- Know location and function of all controls.
- Keep all shields in place.
- Stay clear of power driving parts.
- Never carry riders.
- Keep children and pets a safe distance away from machine.
- Remove attachment from power unit on a level, flat, hard surface.
- Before leaving machine:
 - Stop engine.
 - Set park brake.

- Lower or block up machine.
- Remove key.

Warning - Avoid Injury from Pinch Point

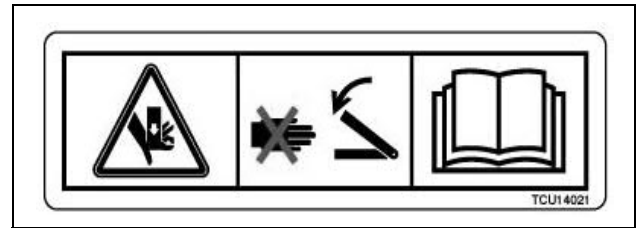

TCU14021

Picture Note: Optional electric actuator kit shown.

- To avoid injury, keep hands and fingers away from this area.

Caution - Avoid Injury from Being Crushed or Cut

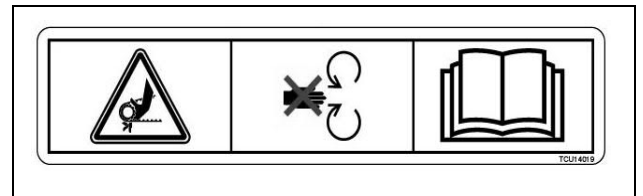

TCU14019

Picture Note: Optional electric hose reel kit shown.

- Moving parts can crush and cut. Keep hands clear. Do not operate with guards removed.

CE Certification and Specification Label

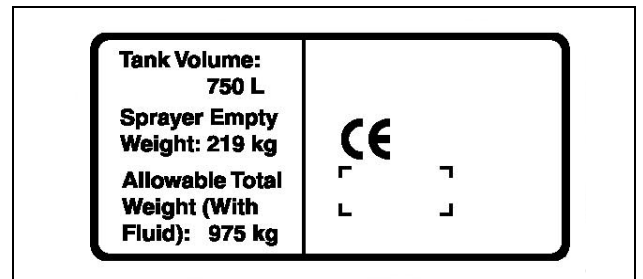

TCU18622

- This label on your machine indicates that this model has been certified and is in compliance with European Directive 98/37/EC (89/392EEC) Standards.

Safety

Read the general safety operating precautions in your machine operator's manual for additional safety information.

Operate Safely

- Read the machine and attachment operator's manual carefully. Be thoroughly familiar with the controls and the proper use of the equipment. Know how to stop the machine and disengage the controls quickly.
- Do not let children or an untrained person operate machine.
- Make any necessary adjustments before you operate. Never attempt to

SAFETY

make any adjustments while the engine is running, unless if recommended in adjustment procedure.

- Take all possible precautions when leaving the machine unattended. Shut off the engine before making any repairs, adjustments, or inspections. Lower the attachment, lock the parking brake, stop the engine, and remove the key.
- Look behind machine before you back up. Back up carefully.
- Do not let anyone, especially children, ride on machine or attachment. Riders are subject to injury such as being struck by foreign objects and being thrown off. Riders may also obstruct the operator's view, resulting in the machine being operated in an unsafe manner.
- Use only attachments and accessories approved by the manufacturer of this product.
- If the machine vibrates abnormally, stop the engine and check immediately for the cause. Vibration is generally a warning of trouble.
- Always refer to the Storage section of the operator's manual for important details if storing this product for a long period of time.
- Keep people and pets out of the work area. Stop machine if anyone enters the area.
- If you hit an object, stop the machine and inspect it. Make repairs before you operate. Keep machine properly maintained and in good working order. Keep all shields and guards in place.
- Always inspect the sprayer completely before and after each use. Before pressurizing the system, check to be sure all fittings and hoses are tightly installed. Be sure guards and shields are in good condition and fastened in place. Make any necessary adjustments before you operate.
- Never use the sprayer during windy conditions.
- Always release pressure in the system before filling, cleaning or servicing the sprayer.
- Do not put nozzle tip or other sprayer parts to your lips to blow out dirt. Use compressed air.
- If the sprayer is mounted to the bed of a utility vehicle, never raise the bed with the sprayer installed. Empty the sprayer and remove it from the bed if you need to raise the bed for any reason.

Parking Safely

1. Stop vehicle on a level surface, not on a slope.
2. Lock park brake.
3. Stop engine.
4. Remove key.
5. Before you leave the operator's seat, wait for engine and all moving parts to stop.
6. Disconnect the negative battery cable or remove the spark plug wire (for gasoline engines) before servicing the machine.

Mix and Handle Chemicals Safely

- It is best to wear full cover clothing and always wear protective goggles and rubber gloves to protect yourself while handling chemicals.
- Follow instructions on chemical container labels.
- Open all chemical containers carefully, using proper tools.
- Open, pour, weigh and mix chemicals in a well-ventilated area.
- Reserve all equipment used for the application of chemicals exclusively for that purpose.
- Prohibit all smoking, drinking and eating food in chemical-handling area.

- It is a good practice to take a soapy shower immediately after the using the sprayer to apply chemicals.
- Wash all clothing worn when using chemicals separately in the laundry after spraying is completed.

Read Chemical Container Label

- Chemicals can be dangerous. Improper selection or use can injure persons, animals, plants, soils or other property. Select the right chemical for the job and handle and apply with care.
- Read the instructions, precautions, and warnings on the container label before opening. Use the product strictly according to label directions for specific applications, in the amounts specified, at the times specified and only when needed.
- Keep the container closed tightly except when preparing the mix.
- Do not remove labels from chemical containers. Store all chemicals in their original containers.
- Do not mix chemicals unless stated on the container label.
- Store chemicals when not in use according to the container label.

Handle Chemical Products Safely

- Direct exposure to hazardous chemicals can cause serious injury. Potentially hazardous chemicals used with John Deere equipment include pesticides, herbicides and fungicides.
- A Material Safety Data Sheet (MSDS) provides specific details on chemical products: physical and health hazards, safety procedures, and emergency response techniques.
- The MSDS should be obtained from the chemical dealer at the time of the chemical purchase.
- Check the MSDS before beginning any job using a hazardous chemical. Know exactly what the risks are and how to do the job safely. Always wear recommended personal protection equipment.

Practice Safe Maintenance

- Only qualified, trained adults should service this machine.
- Understand service procedure before doing work. Keep area clean and dry.
- Do not operate the engine in a confined space where dangerous carbon monoxide fumes can collect.
- Never lubricate, service or adjust the machine or attachment while it is moving. Keep safety devices in place and in working condition. Keep hardware tight.
- Keep hands, feet, clothing, jewelry, and long hair away from any moving parts, to prevent them from getting caught.
- Lower any attachment completely to the ground or to an existing attachment mechanical stop before servicing the attachment. Disengage all power and stop the engine. Lock park brake and remove the key. Let machine cool.
- Disconnect battery or remove spark plug wire (for gasoline engines) before making any repairs.
- Before servicing machine or attachment, carefully release pressure from any components with stored energy, such as hydraulic components and springs.
- Release hydraulic pressure by lowering attachment or cutting units to the ground or to a mechanical stop and move hydraulic control levers.
- Securely support any machine or attachment elements that must be raised for service work. Use jack stands or lock service latches to support

PREPARING VEHICLE

components when needed.

- Never run engine unless park brake is locked.
- Keep all parts in good condition and properly installed. Fix damage immediately. Replace worn or broken parts. Replace all worn or damaged safety and instruction decals.
- Check all hardware at frequent intervals to be sure the equipment is in safe working condition.
- Do not modify machine or safety devices. Unauthorized modifications to the machine or attachment may impair its function and safety.

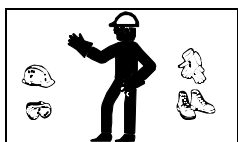

Wear Appropriate Clothing

- Wear close fitting clothing and safety equipment appropriate for the job.
- Certain operating conditions may dictate that the operator and any passenger wear

appropriate safety equipment while operating the vehicle. Be prepared for any existing and potential conditions before operating machine.

- Local safety or insurance regulations may require additional safety equipment such as eye protection or a hard hat.
- Always wear substantial footwear and long trousers. Do not operate the equipment when barefoot or wearing open sandals.
- Wear proper clothing and safety equipment while handling chemicals or using the sprayer. Refer to the MSDS for the chemicals being used to be sure the proper personal protection equipment is being used.



Avoid High Pressure Fluids

- Hydraulic hoses and lines can fail due to physical damage, kinks, age, and exposure. Check hoses and lines regularly. Replace damaged hoses and lines.

- Hydraulic fluid connections can loosen due to physical damage and vibration. Check connections regularly. Tighten loose connections.
- Escaping fluid under pressure can penetrate the skin causing serious injury. Avoid the hazard by relieving pressure before disconnecting hydraulic or other lines. Tighten all connections before applying pressure.
- Search for leaks with a piece of cardboard. Protect hands and body from high pressure fluids.
- If an accident occurs, see a doctor immediately. Any fluid injected into the skin must be surgically removed within a few hours or gangrene may result. Doctors unfamiliar with this type of injury should reference a knowledgeable medical source. Such information is available from Deere & Company Medical Department in Moline, Illinois, U.S.A. Information may be obtained in the United States and Canada only by calling 1-800-822-8262.

Dispose of Chemicals Properly

- Proper disposal of excess spray material is very important. If you have excess tank solution, it is best to dilute it with water and apply it to the area you previously treated.
- Never dump solution into a drain or near a lake or stream.
- Chemicals containers should be triple-rinsed, with the rinse water added to the sprayer tank. Do not burn empty chemical containers. Dispose of containers at recycling centers.

Handling Waste Product and Chemicals

Waste products, such as, used oil, fuel, coolant, brake fluid, and batteries, can harm the environment and people:

- Do not use beverage containers for waste fluids - someone may drink from them.
- See your local Recycling Center or authorized dealer to learn how to recycle or get rid of waste products.
- A Material Safety Data Sheet (MSDS) provides specific details on chemical products: physical and health hazards, safety procedures, and emergency response techniques. The seller of the chemical products used with your machine is responsible for providing the MSDS for that product.

Preparing Vehicle

Preparing the Machine

Machine Requirements

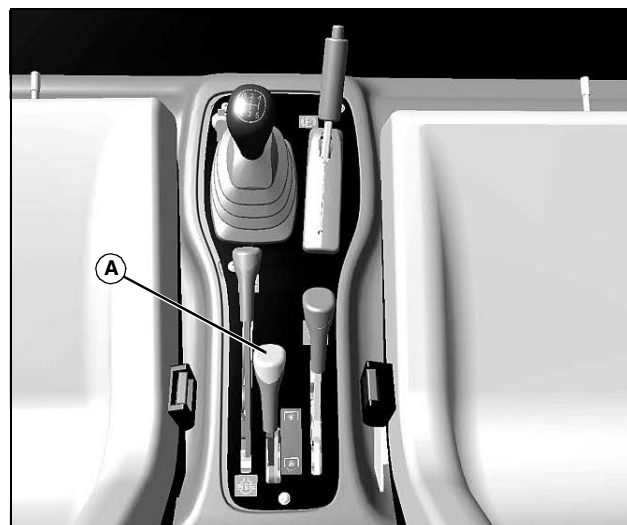

MX19916

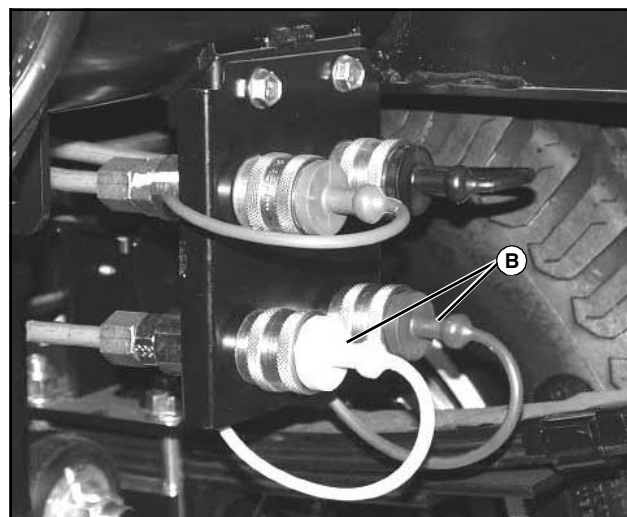

MX2928

Your machine must be equipped with optional Auxiliary Hydraulic Kit for operation of the sprayer pump. If machine is equipped with PTO control lever (A), two quick-couplers (B) at the rear of the machine, an auxiliary tank, and oil cooler, the Auxiliary Hydraulic Kit is installed. If necessary, see your John Deere dealer to order kit.

Thank you so much for reading.
Please click the “Buy Now!”
button below to download the
complete manual.



After you pay.

You can download the most
perfect and complete manual in
the world immediately.

Our support email:

ebooklibonline@outlook.com