

Product: WHEEL SKIDDER

Model: 518 WHEEL SKIDDER 94U

Configuration: 518 SKIDDER 94U00287-00690 (MACHINE) POWERED BY 3304 ENGINE

Disassembly and Assembly 3304B and 3306B Engines for Caterpillar Built Machines

Media Number -SEN5598-09

Publication Date -01/01/2013

Date Updated -25/01/2013

i00886792

Governor - Disassemble

SMCS - 1264-015

Disassembly Procedure

Table 1

Required Tools			
Tool	Part Number	Part Description	Qty
A	1P-0510	Driver Group	1
B	6V-2163	Spring Clamp	1
C	1P-1855	Retaining Ring Pliers	1

Start By:

- A. Remove the fuel injection pump housing and the governor. Refer to Disassembly and Assembly, "Fuel Injection Pump Housing and Governor - Remove".

Note: To remove the governor for the disassembly of the fuel injection pump housing, perform Steps 1, 2, 16, 22, 24, 25, 26, 27, 30, 32 and 34.

NOTICE

Keep all parts clean from contaminants.

Contaminants may cause rapid wear and shortened component life.

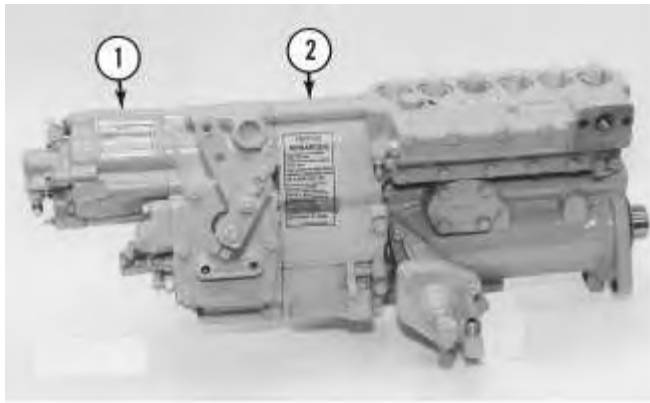

Illustration 1

g00453006

1. Remove fuel ratio control (1) from governor (2) .

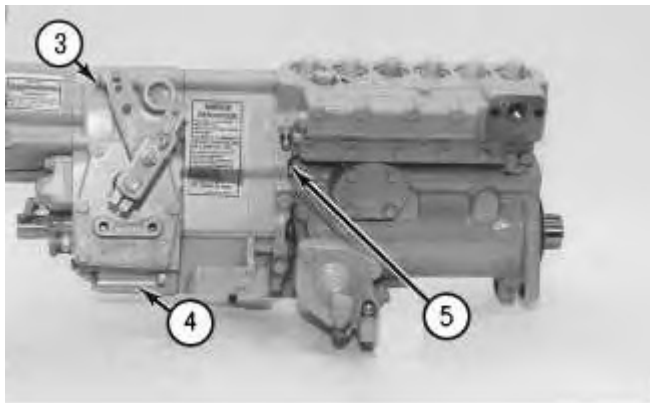

Illustration 2

g00453007

Note: Illustration 2 shows the fuel ratio control that is still connected.

2. Remove six bolts (3), two bolts (5), housing (4) and the gasket.

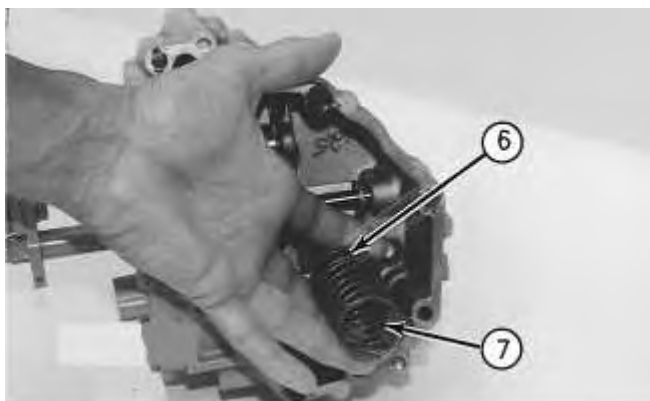

Illustration 3

g00453008

3. Remove governor spring (7), seat (6) and the washers.

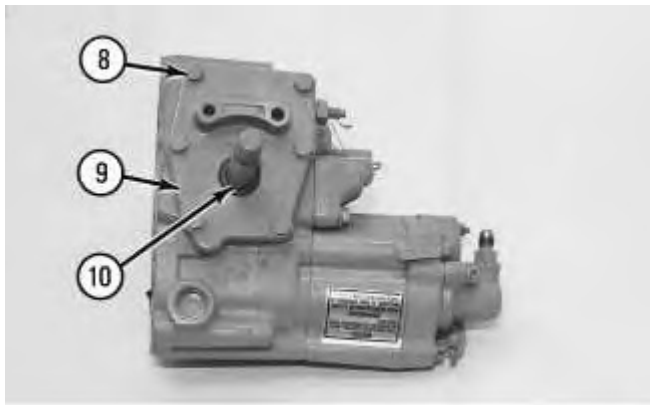

Illustration 4

g00453009

4. Remove six bolts (8), cover (9) and the gasket. Use Tool (A) in order to remove seal (10) .

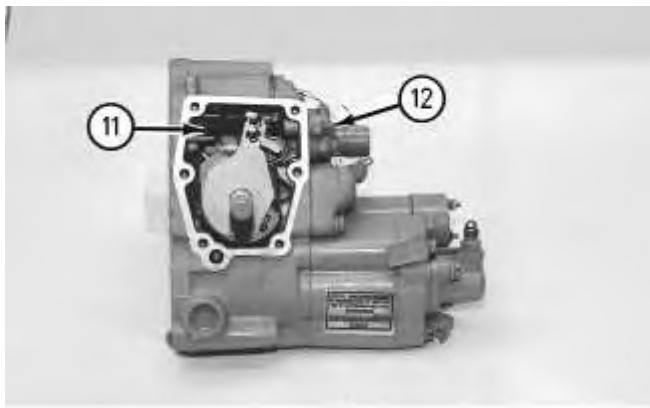
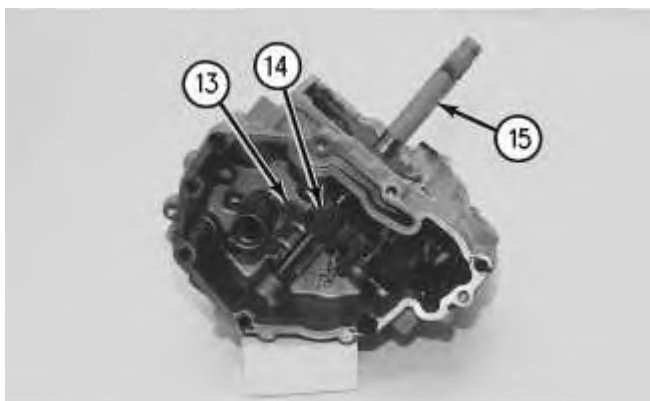

Illustration 5

g00453010

5. Remove low idle adjustment screw (12) and spring (11) .



6. Remove shaft assembly (15) and levers (14) and (13) .

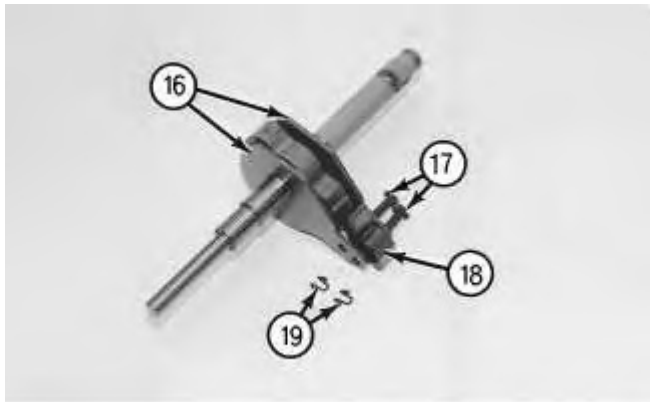

Illustration 7

7. Remove two snap rings (19) from two pins (17). Remove two pins (17). Remove plates (16) and stop (18) .

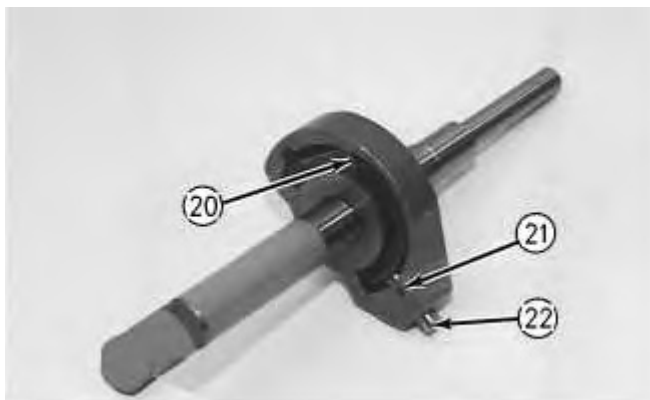

Illustration 8

8. Remove pins (21) and (22) and remove spring (20) .
-

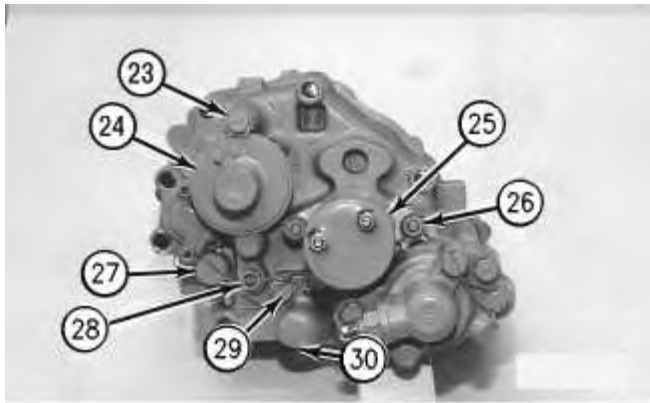

Illustration 9

g00453015

9. Remove two bolts (23), and the washers, and remove adapter (24), the coupling, and the O-ring seal.
10. Remove contact (27) and body (28) with an O-ring seal.
11. Remove two bolts (29) and the washers and remove cover (30) and the gasket.
12. Remove two nuts and washers (26) and remove shutoff solenoid (25) and the gasket.

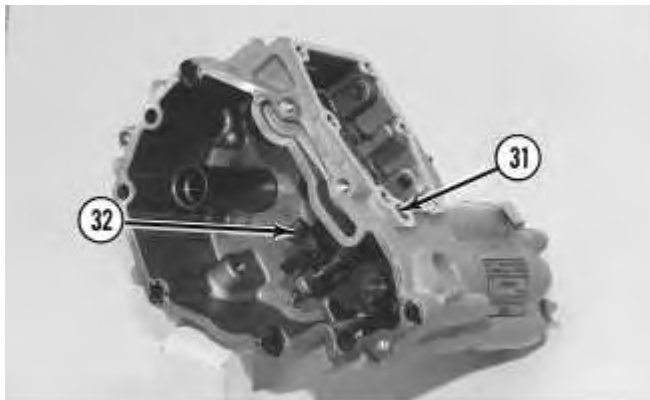

Illustration 10

g00453016

13. Remove shaft (31) and lever (32) .
-

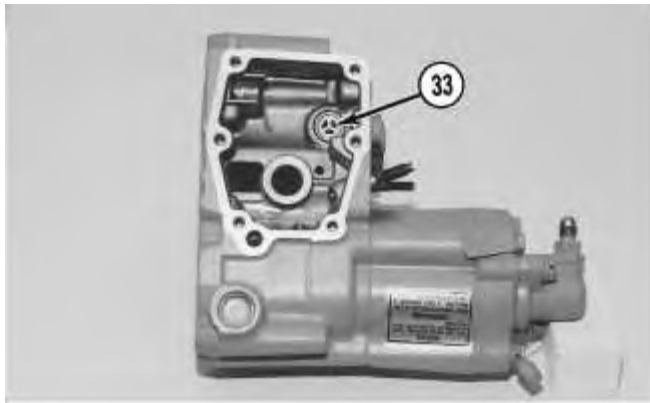

Illustration 11

g00453017

Note: The check valve will be damaged during removal. Remove check valve (33) only if a replacement is necessary.

14. Remove check valve (33) only if a replacement is necessary.

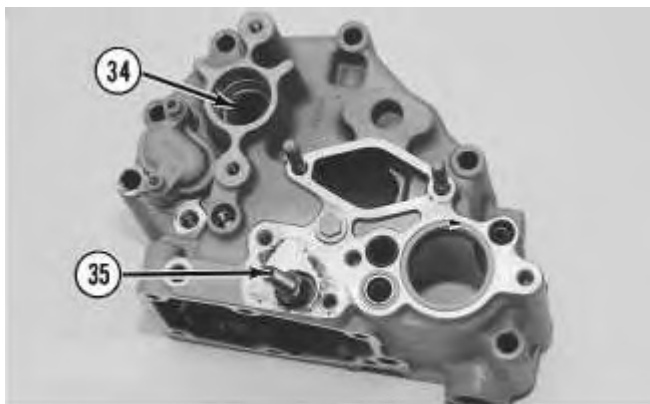
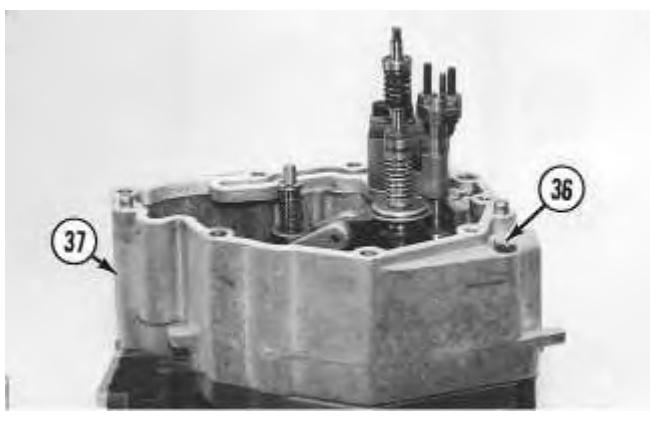

Illustration 12

g00453018

15. Remove seal (34) and adjustment screw (35) .



16. Remove bolt (36), housing (37) and the gasket from the fuel injection pump housing.

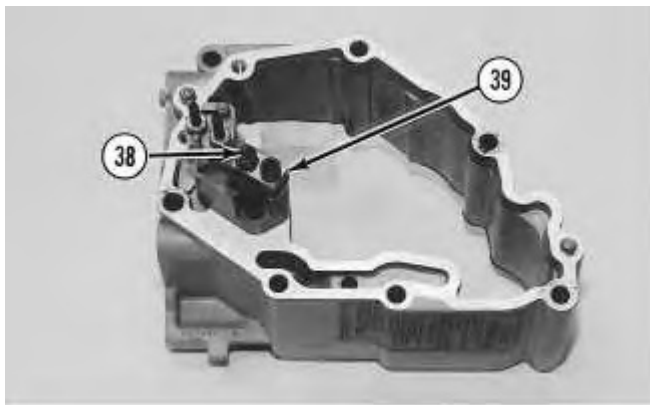

Illustration 14

g00453557

Typical example

17. Remove bolts (38) and remove torque control (39) .
18. Disassemble torque control (39) and inspect the spacer, the spring, and the insulator for damage or wear. Replace parts that are worn or damaged with new parts.

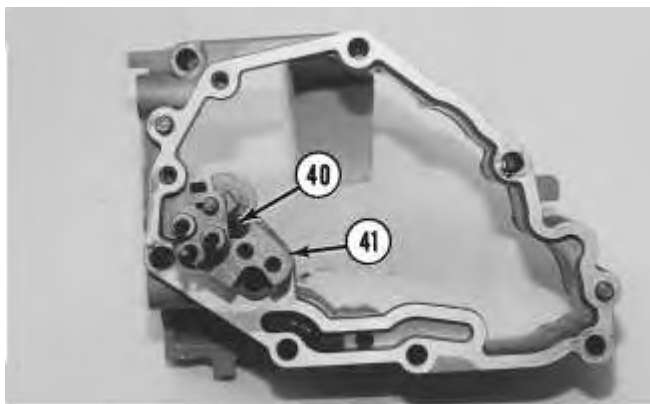

Illustration 15

g00453558

19. Remove two bolts (40) and block (41) .
-

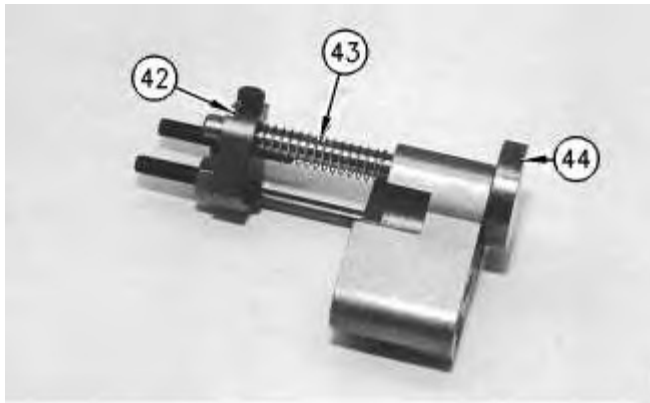

Illustration 16

g00453559

20. Remove the bolt that holds collar (42) to bolt (44). Remove collar (42), spring (43) and bolt (44) .
21. Remove the stop screws from collar (42) if the collar needs to be replaced.

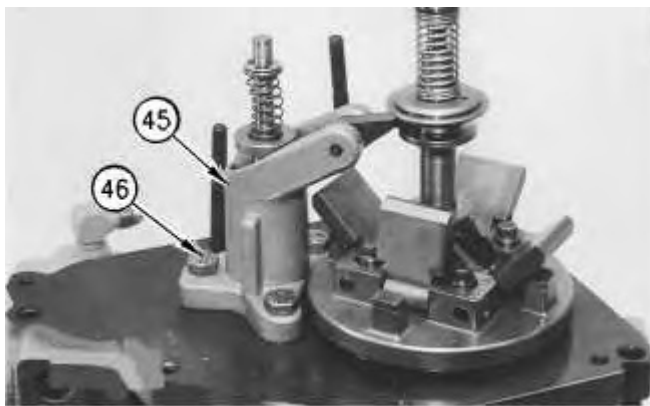
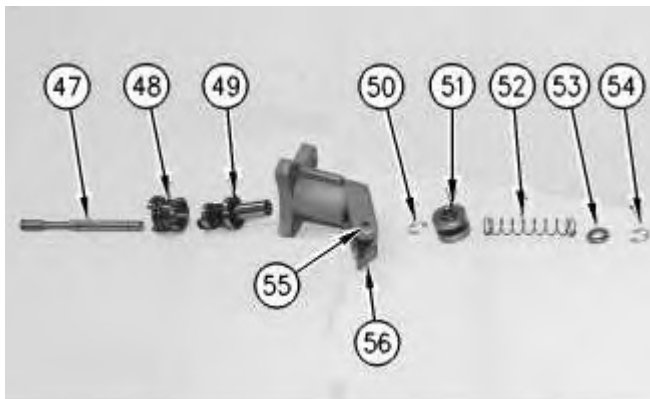

Illustration 17

g00453560

22. Remove three bolts (46) and remove governor servo (45). The governor servo must be rotated in order to be released from the rack's regulator.



23. Remove locking (50), seat (53), link spring (52) and sleeve (51). Remove the other locking (50) from the groove in the center of valve (47). Remove valve (47), sleeve (48) and piston (49). The piston must be pushed down in order to be removed. Remove the O-ring seal from sleeve (48). Remove pin (55) and lever (56) .

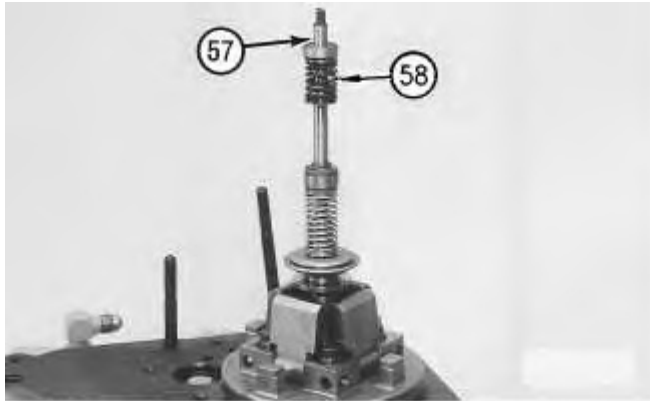

Illustration 19

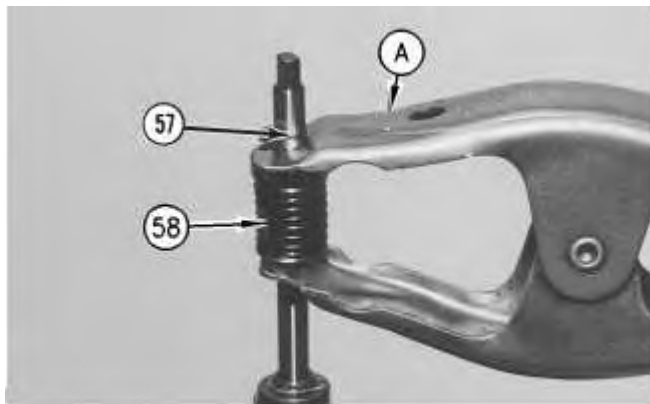

Illustration 20

24. Use Tool (A) in order to hold spring (58) compressed for the removal of ring (57). Spring (58) is used in order to put a preload on the thrust bearing for the camshaft in the fuel injection pump housing.
25. Remove ring (57) and slowly release Tool (A) .

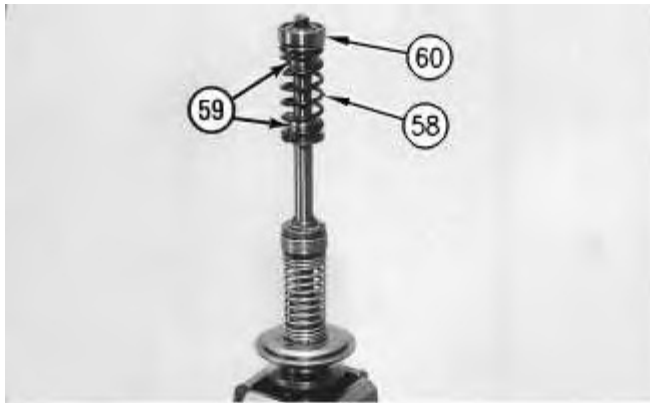

Illustration 21

g00453635

26. Remove bearing (60), sleeves (59) and spring (58) .



Illustration 22

g00453636

27. Remove ring (61) and dashpot assembly (62) .

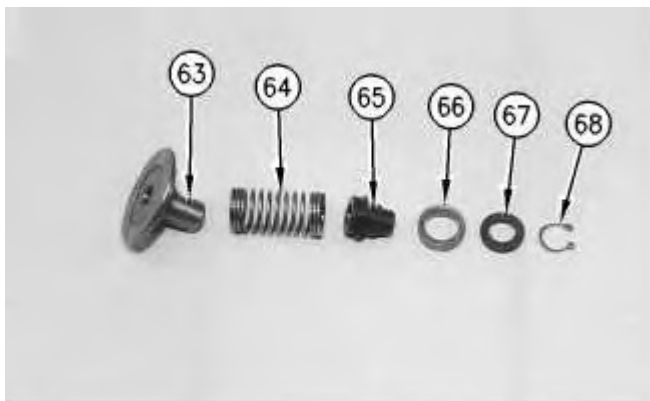

Illustration 23

g00453637

28. Use Tool (C) in order to remove snap ring (68). Remove ring (67) and spool (66) .

29. Remove seat (65) from spring (64) and remove spring (64) from seat (63) .

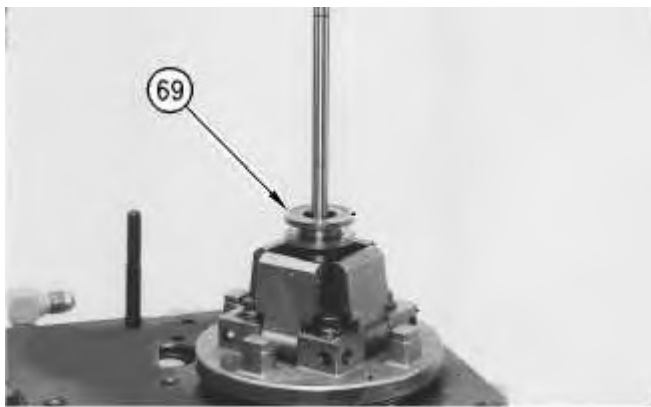

Illustration 24

g00453665

30. Remove riser (69) .

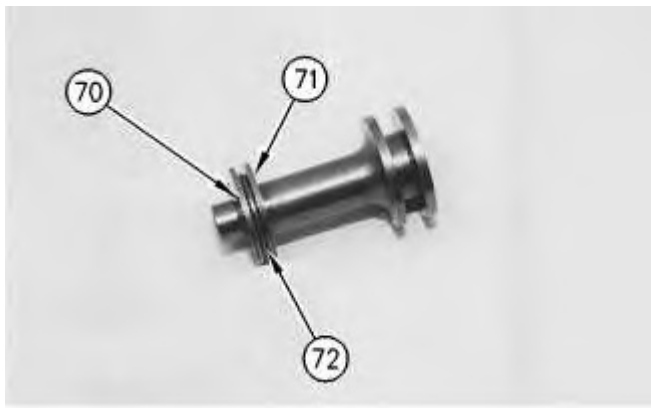
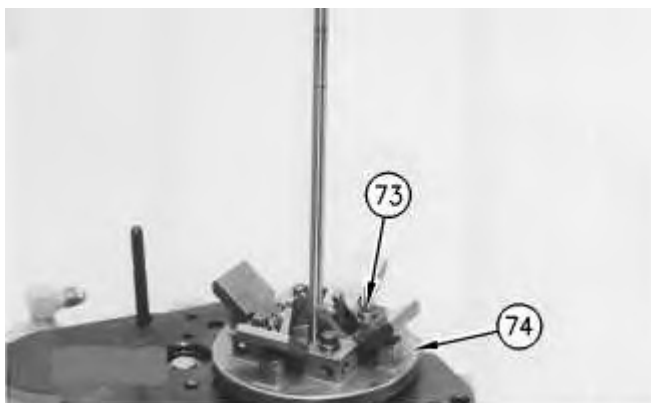

Illustration 25

g00453667

31. Remove ring (70), races (71) and bearing (72) .



32. Remove four bolts (73) and carrier (74) .

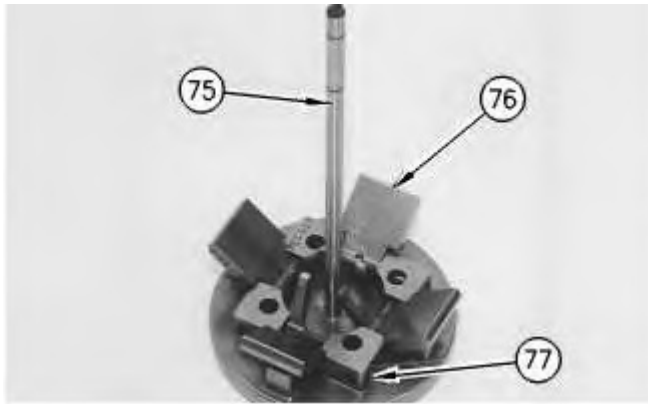

Illustration 27

33. Remove dowels (77) and flyweights (76). Remove governor shaft (75) and the dowel that is not shown from shaft (75) .

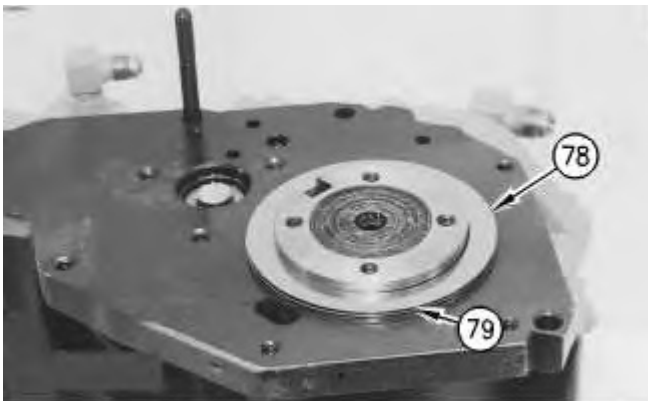

Illustration 28

34. Remove races (78) and bearing (79) .
-

Product: WHEEL SKIDDER

Model: 518 WHEEL SKIDDER 94U

Configuration: 518 SKIDDER 94U00287-00690 (MACHINE) POWERED BY 3304 ENGINE

Disassembly and Assembly 3304B and 3306B Engines for Caterpillar Built Machines

Media Number -SEN5598-09

Publication Date -01/01/2013

Date Updated -25/01/2013

i01111261

Governor - Assemble

SMCS - 1264-016

Assembly Procedure

Table 1

Required Tools			
Tool	Part Number	Part Description	Qty
A	1P-1855	Retaining Ring Pliers	1
B	6V-2163	Spring Clamp	1
C	1P-0510	Driver Group	1
D	6V-2054	Shield Driver	1

Note: Put clean engine oil on all parts before assembly. Ensure that all of the oil passages are clear.

Note: Check the condition of the gaskets and the O-ring seals. If the gaskets, the seals, or any parts are worn or damaged, use new parts for replacement.

NOTICE

Keep all parts clean from contaminants.

Contaminants may cause rapid wear and shortened component life.

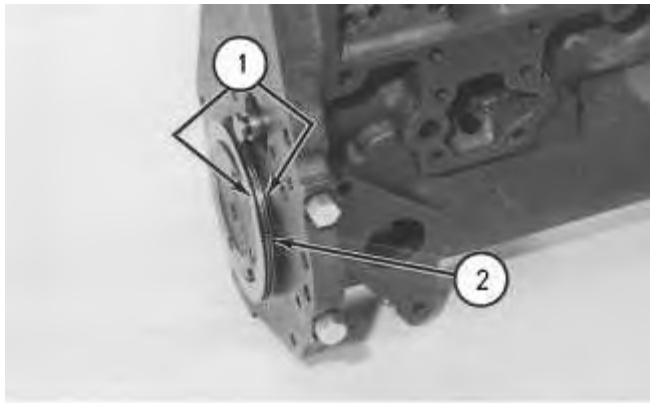

Illustration 1

g00453799

1. Install one race (1), bearing (2) and the other race (1) on the camshaft in the fuel injection pump housing.

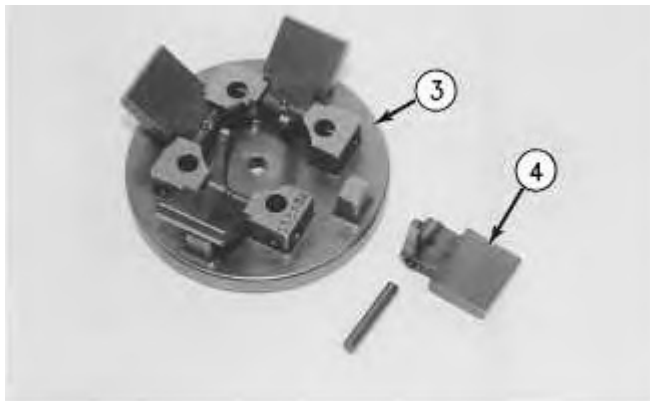

Illustration 2

g00453801

2. Put flyweights (4) in position on carrier (3) and install the dowels in order to hold the flyweights in place. The flyweights must move freely on the dowels.

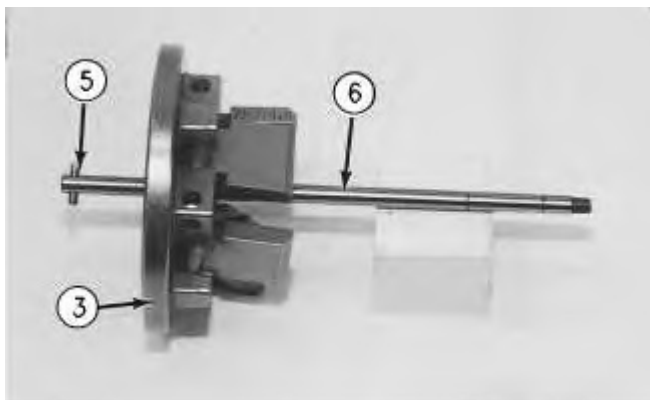

Illustration 3

g00453802

3. Install dowel (5) in governor shaft (6) and install the governor shaft in the carrier (3) .

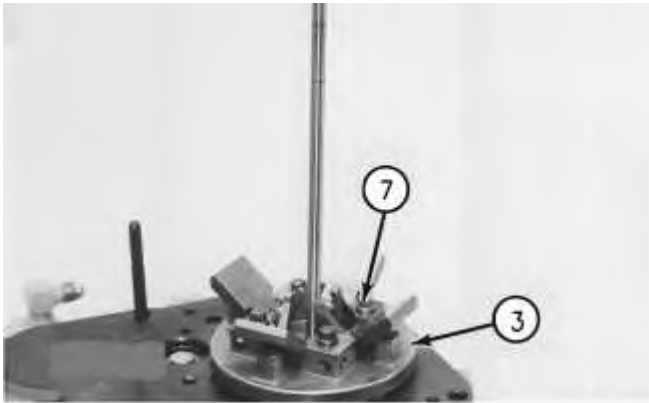

Illustration 4

g00459340

4. Put carrier (3) in position and install bolts (7) .

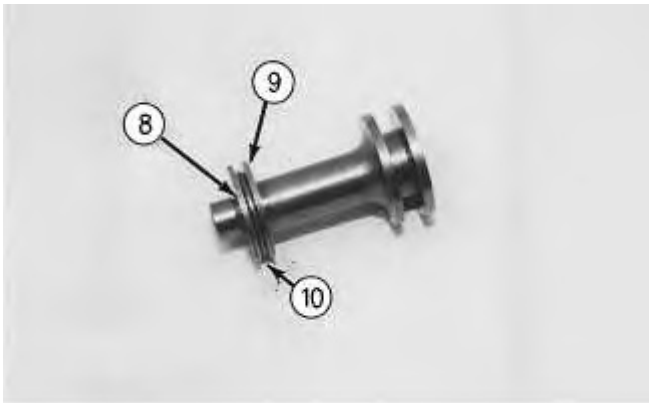

Illustration 5

g00459410

5. Install race (9), bearing (10) and race (9). Use Tool (A) in order to install ring (8) on riser (11) .

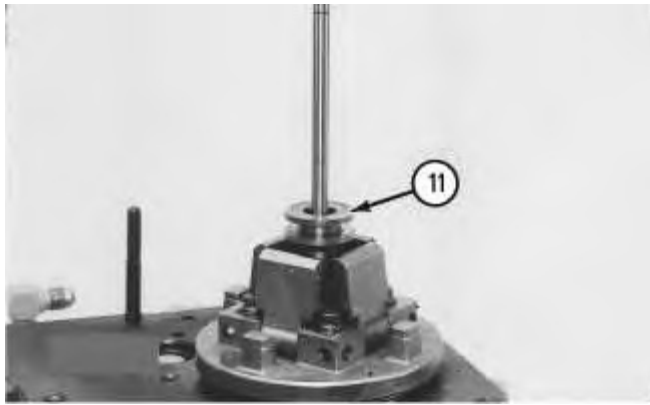

Illustration 6

g00459411

6. Install riser (11) .

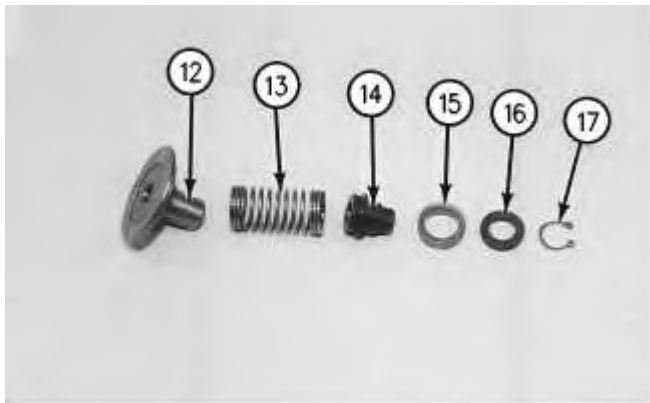

Illustration 7

g00459414

7. Assemble the dashpot, as follows:
 - a. Install spring (13) on seat (12) and install seat (14) in spring (13) .
 - b. Put pool (15) and ring (16) in position on seat (14) and use Tool (A) in order to install snap ring (17) .

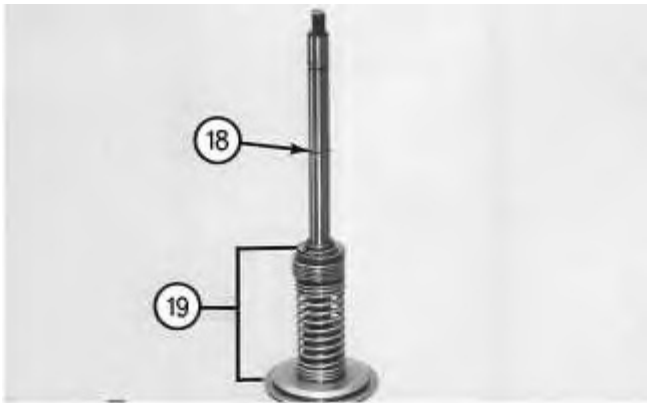

Illustration 8

g00459416

8. Install dashpot assembly (19). Install ring (18) in the lower groove in the governor shaft.

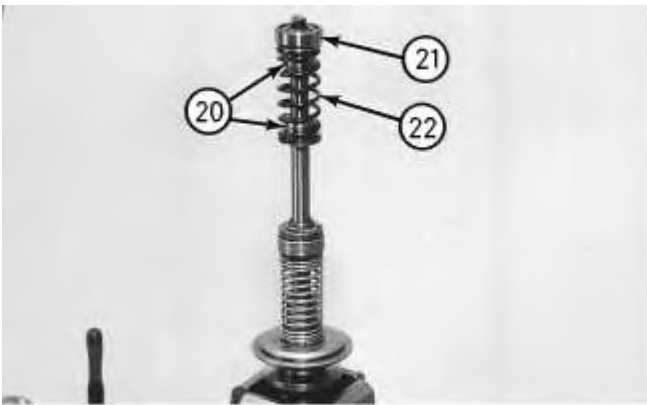
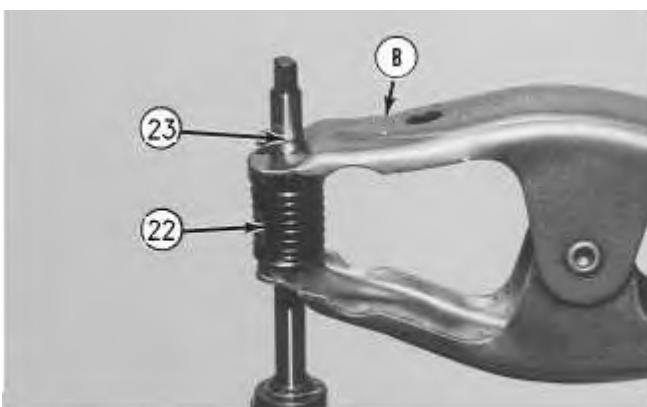

Illustration 9

g00459419

9. Install sleeve (20), spring (22), sleeve (20) and bearing (21) .

Note: Spring (22) is used in order to put a preload on the thrust bearing on the camshaft in the fuel injection pump housing.



10. Use Tool (B) in order to hold spring (22) compressed and install ring (23) in the groove in the governor shaft. Remove Tool (B) .

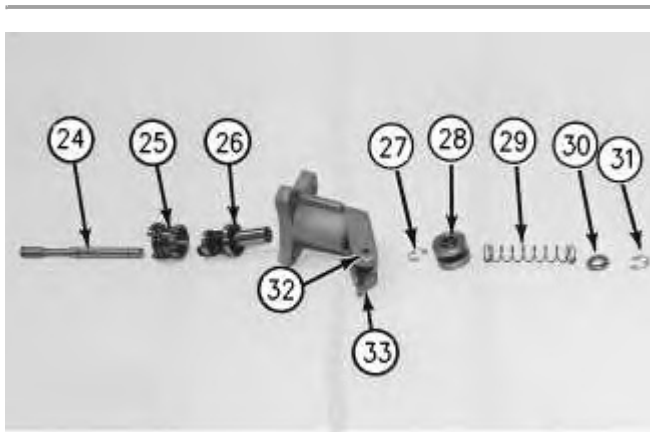

Illustration 11

11. Put lever (33) in position on the governor servo and install pin (32) in order to hold the lever in place. Use a hammer and a chisel in order to move the metal (stake) at four places that are spread apart 90 degrees. Perform this procedure on the outside surface on both legs of the governor servo. This helps to hold pin (32) in place.
12. Install the O-ring seal on sleeve (25). Install piston (26) and sleeve (25) .
13. Install valve (24) .
14. Install one lockring (27) in the groove near the center of valve (24). Put sleeve (28), link spring (29) and seat (30) in position on valve (24) and install second lockring (31) .

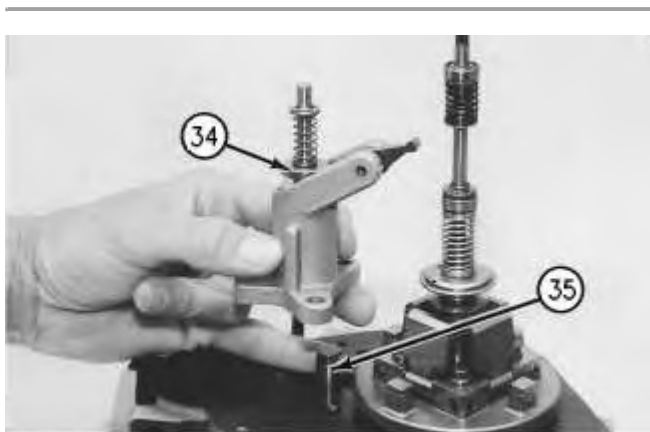

Illustration 12

15. Put the governor servo in position on the fuel injection pump housing with piston (34) that is engaged over rack control sleeve (35) and install the bolts that hold the rack control sleeve in place.

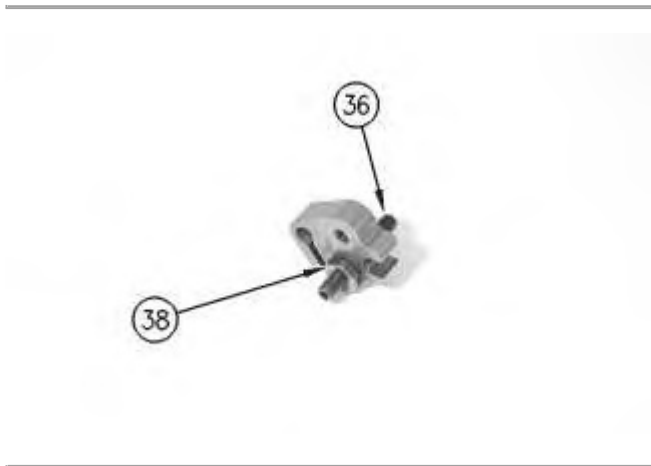

Illustration 13

g00591527

3304B engine

Note: The 3304B engine has one stop screw (36) and one locknut (38).

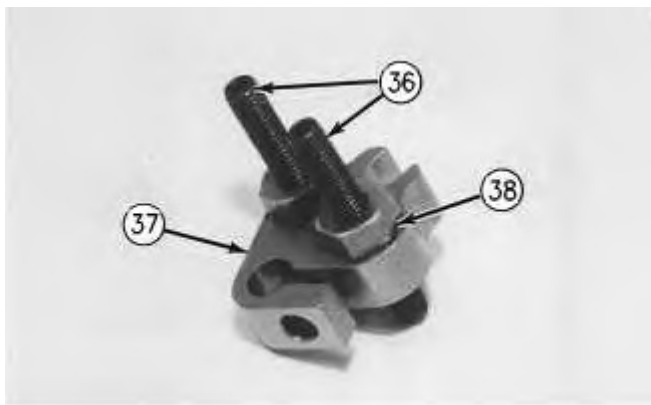

Illustration 14

g00454274

3306B

16. If the stop screws were removed, install two stop screws (36) in collar (37), as shown. Install locknuts (38) .
-

Thank you so much for reading.
Please click the “Buy Now!”
button below to download the
complete manual.



After you pay.

You can download the most
perfect and complete manual in
the world immediately.

Our support email:

ebooklibonline@outlook.com