

Product: MINI HYD EXCAVATOR

Model: 303.5E MINI HYD EXCAVATOR RKY

Configuration: 303.5E Mini Hydraulic Excavator RKY00001-UP (MACHINE) POWERED BY C1.8 Engine

## **Disassembly and Assembly 303E CR, 303.5E, 304E, 305.5E and 305E Mini Hydraulic Excavators Machine Systems**

Media Number -UENR0148-04

Publication Date -01/10/2016

Date Updated -25/10/2016

i04778100

## **Swing Motor and Swing Drive - Assemble**

SMCS - 5058-016-ZW; 5459-016

### **Assembly Procedure**

Table 1

<b>Required Tools</b>			
<b>Tool</b>	<b>Part Number</b>	<b>Part Description</b>	<b>Qty</b>
C	1P-1857	Retaining Ring Pliers	1
D	1P-1859	Retaining Ring Pliers	1

---

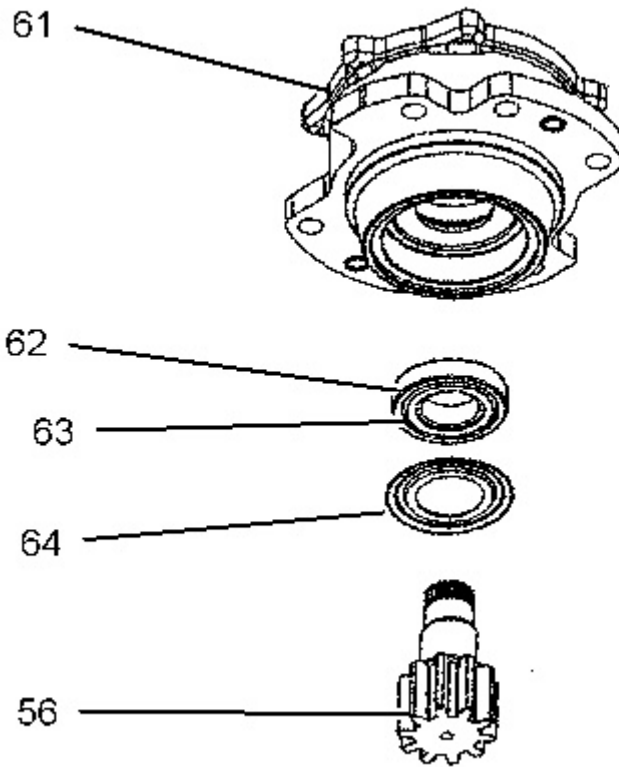

---

Illustration 1

g01250188

1. Lower the temperature of bearing cup (62).
2. Install bearing cup (62) into housing (61).
3. Install seal (64) and bearing cone (63) onto shaft (56).



---

Illustration 2

g01250187

4. Lower the temperature of bearing cup (59).
  5. Install lip seal (60) and bearing cup (59).
-

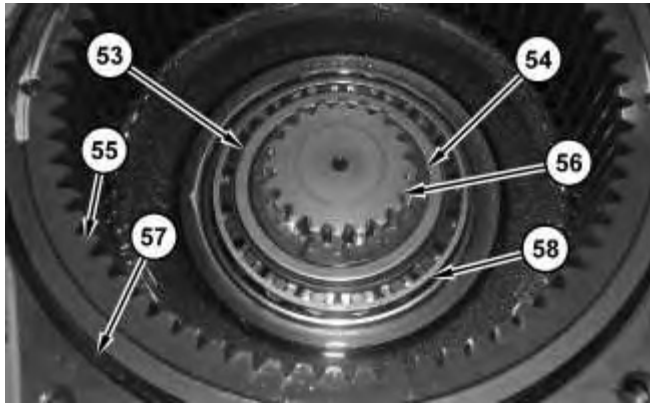

Illustration 3

g01250186

6. Install shaft (56) and bearing cone (58).
7. Install retainers (54), ring (53), ring gear (55), and O-ring seal (57).

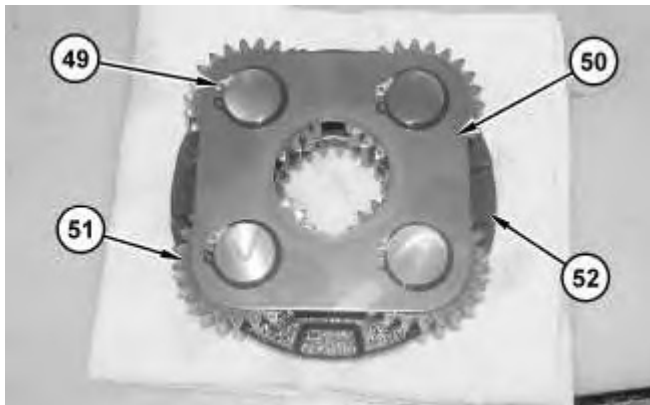

Illustration 4

g01250185

8. Install the bearings, gears (51), and plate (50) onto carrier (52).
9. Use Tooling (D) in order to install retaining ring (49).

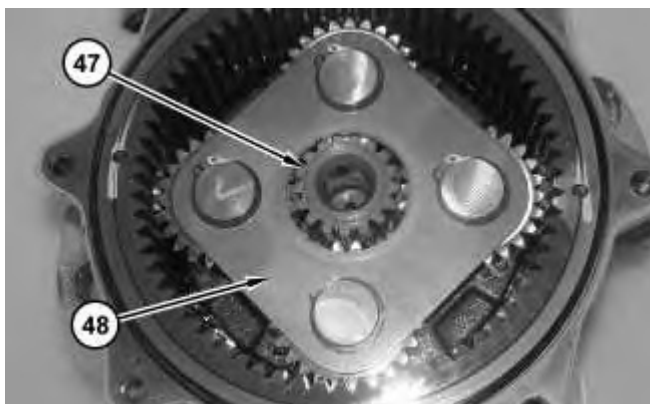

Illustration 5

g01250184

10. Install carrier assembly (48) and gear (47).

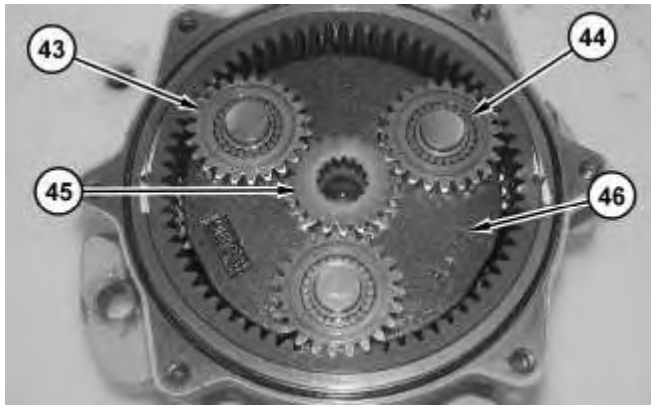

Illustration 6

g01250183

11. Install carrier (46), gear (45), bearings (44), and gears (43).

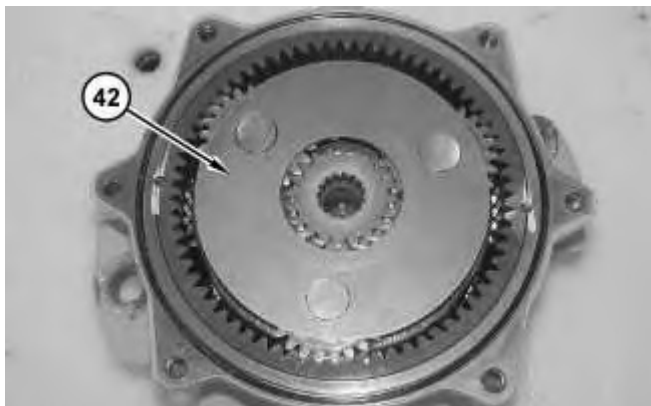

Illustration 7

g01250182

12. Install plate (42).

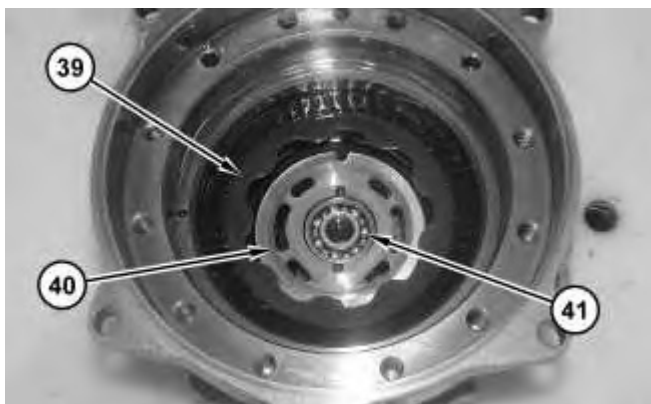

Illustration 8

g01250181

13. Install bearing (41), port plate (40), and plate (39).
-

Thank you so much for reading.  
Please click the “Buy Now!”  
button below to download the  
complete manual.



After you pay.

You can download the most  
perfect and complete manual in  
the world immediately.

Our support email:

[ebooklibonline@outlook.com](mailto:ebooklibonline@outlook.com)