

# omar178076 - 8120, 8220, 8320, 8420, and 8520 Tractors (Export Edition) Operating Lights

## Operating Lights

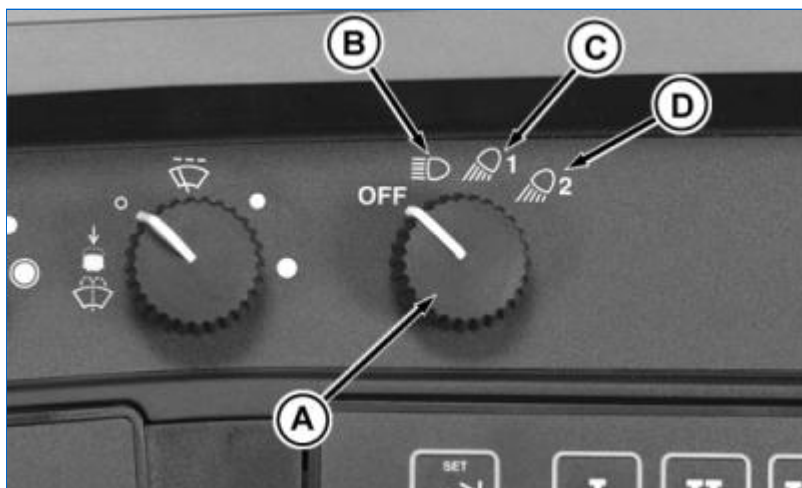

RW26637-UN: Light Controls

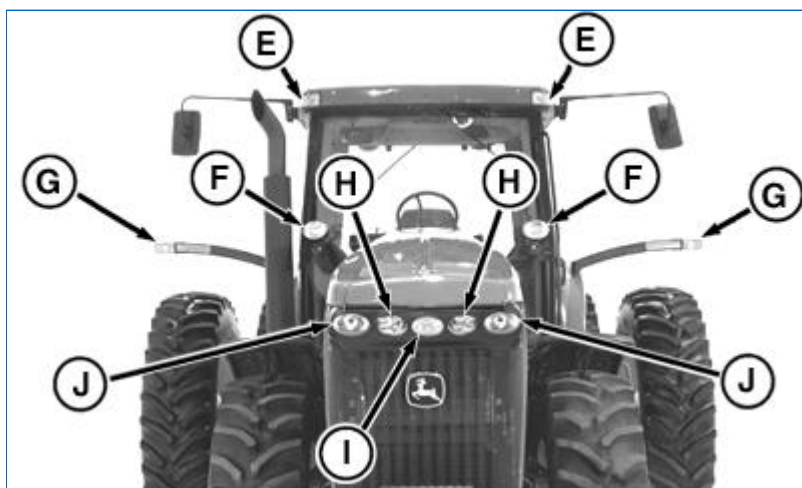

RXA0052425-UN: Front Light Locations

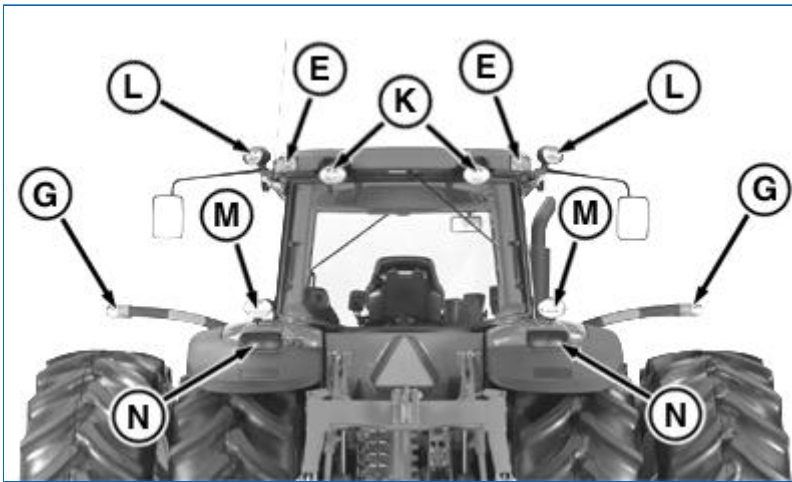

RXA0058114-UN: Rear Light Locations

**LEGEND:**

- A - Light Switch
- B - Road Position
- C - Field Position 1
- D - Field Position 2
- E - Amber Hazard Lights
- F - Mid-Body Floods
- G - Extremity Transport Warning Lights
- H - Front Grille Floods
- I - Spot Light *(If Equipped)*
- J - Head Lights
- K - Rear Roof Floods
- L - Side-Mounted Floods *(If Equipped)*
- M - Rear Fender Floods
- N - Red Tail Lights



**CAUTION:**

*Avoid injury caused by accidental collision with another vehicle. Always comply with traffic regulations when driving tractor on a road. Dim headlights to low-beam for oncoming vehicles. Avoid using flood lights which could blind or confuse other drivers.*

The light switch (A) has four positions and operates regardless of key position.

-: Lights-Positions

**OFF POSITION**

Switches Off All Lights

**ROAD POSITION-(B)**

**Low Beam Position:**      **High Beam Position:**

Head Lights

Head Lights

Amber Roof Hazard Lights      Amber Roof Hazard Lights

Tail Lights

Tail Lights

Extremity Warning Lights    Extremity Warning Lights

**FIELD POSITION 1-(C)**

**Low Beam Position:    High Beam Position:**

Head Lights	Head Lights
Front Grille Floods	Front Grille Floods
Rear Fender Floods	Front Grille Spot Light *
	Rear Fender Floods
	Rear Roof Floods

**FIELD POSITION 2-(D)**

**Low Beam Position:    High Beam Position:**

Head Lights	Head Lights
Front Grille Floods	Front Grille Floods
Rear Fender Floods	Front Grille Spot Light *
Mid-Body Floods	Mid-Body Floods
	Rear Fender Floods
	Rear Roof Floods
<i>* If Equipped</i>	Side-Mounted Floods *

# omar178076 - 8120, 8220, 8320, 8420, and 8520 Tractors (Export Edition)

## Operating Turn Signals, Horn and High/Low Beam

---

### Operating Turn Signals, Horn and High/Low Beam

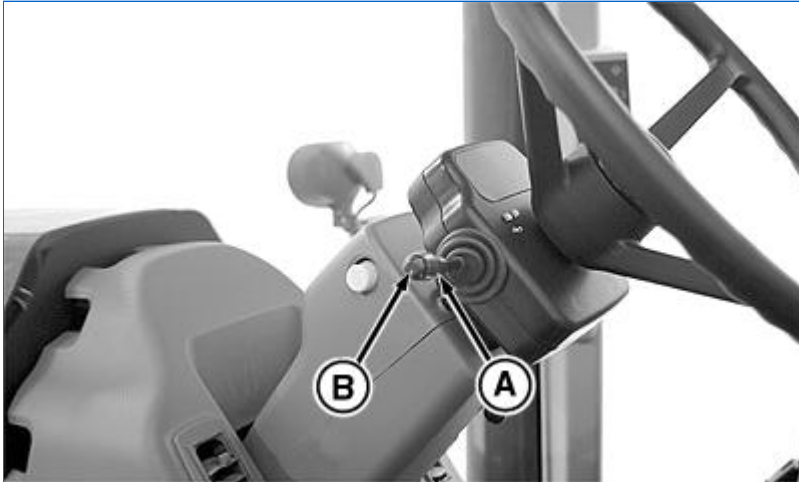

RXA0057084-UN: Push Lever

#### LEGEND:

- A - Turn Signal Indicator Arm
- B - Horn Push Button

### Turn Signals

Push lever (A) up for a right turn, or pull down for a left turn. Return lever to center position after completing turn.

### Horn

Push inward on end (B) to activate horn.

### High/Low Beam

Push lever (A) forward to activate high beam head lights. Pull lever into center position to operate low beam. Pull lever toward you and release to flash high beam.

Dim head lights for oncoming vehicles.

**omar178076 - 8120, 8220, 8320, 8420, and 8520 Tractors (Export Edition)**  
**Using Delayed Egress Lighting- *If Equipped***

---

**Using Delayed Egress Lighting- *If Equipped***



RW26837-UN: Delayed Egress Lighting

**LEGEND:**

A - Light Switch

Momentarily turn light switch (A) counterclockwise from the OFF position to activate delayed egress lighting. Cancel egress lighting by momentarily again turning switch counterclockwise.

Entry and flood lights will remain on for 90 seconds. Lights will then automatically shut off.

# omar178076 - 8120, 8220, 8320, 8420, and 8520 Tractors (Export Edition)

## Operating Hazard Light

---

### Operating Hazard Light

---



#### **CAUTION:**

*To prevent possible personal injury, always operate flashing warning lights when traveling on a highway or public roads except where prohibited by law.*

---



RW26650-UN: Hazard Light Switch

#### LEGEND:

A - Hazard Light Switch

Push top of switch (A) to activate hazard lights.

---

## omar178076 - 8120, 8220, 8320, 8420, and 8520 Tractors (Export Edition) Operating Rotary Beacon Light- *If Equipped*

---

### Operating Rotary Beacon Light- *If Equipped*



RW27013-UN: Beacon Light Switch

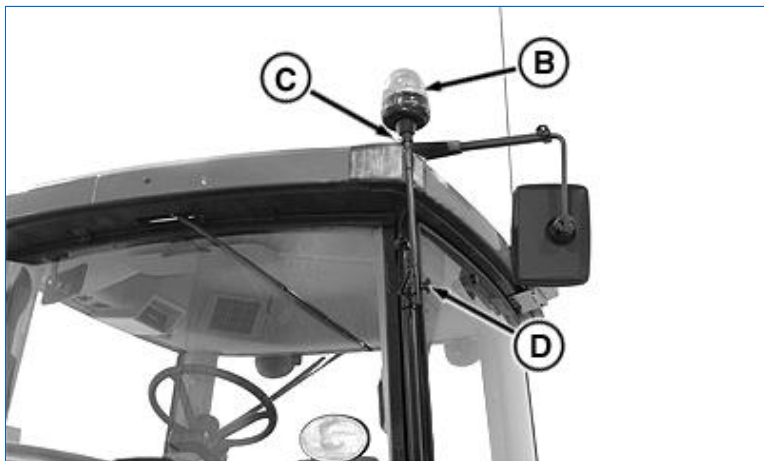

RXA0057392-UN: Beacon Light

#### LEGEND:

- A - Push Switch
- B - Light Assembly
- C - Nut
- D - Bracket Nut

Push switch (A) to activate rotary beacon light assembly (B).

When beacon light is not used:

- Loosen nut (C) and remove light assembly (B)
- Install rubber protective cap on connector
- Loosen bracket nut (D), invert beacon support, and tighten nut

# omar178076 - 8120, 8220, 8320, 8420, and 8520 Tractors (Export Edition)

## Using Extremity Transport Warning Lights

---

### Using Extremity Transport Warning Lights



RXA0052458-UN: Extremity Light

#### LEGEND:

A - Extremity Warning Light

---



#### **CAUTION:**

*Extremity transport warning lights (A) are needed when tractor width exceeds 3.7 m (12 ft.). Always use road lights and transport warning lights when operating tractor on a road or highway at night OR during the day. Extremity transport warning lights alert other vehicles of your extended width.*

---

#### **IMPORTANT:**

**To avoid damage, extremity lights may be retracted when parking tractor in storage building.**

Extremity lights operate with hazard switch in "ON" position or light switch in "road" position.

Adjust extremity warning lights (A) no more than 400 mm (16 in.) from widest point of tractor.

---

**omar178076 - 8120, 8220, 8320, 8420, and 8520 Tractors (Export Edition)**  
**Using Seven-Terminal Outlet**

---

**Using Seven-Terminal Outlet**

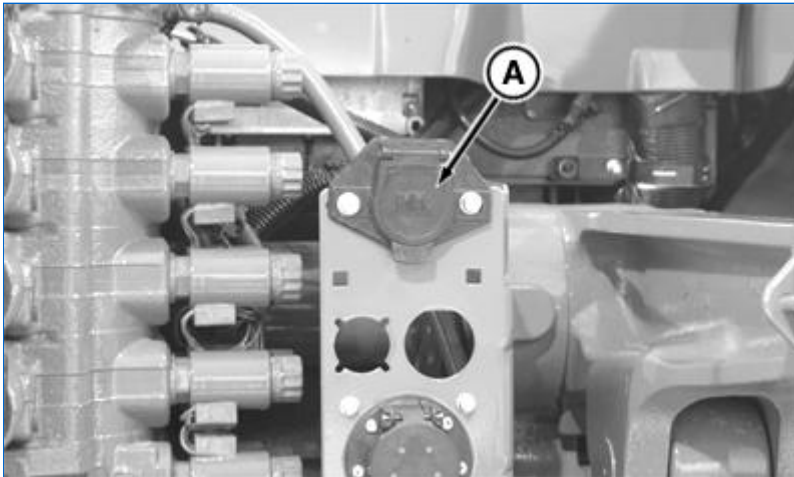

RXA0057048-UN: Seven-Terminal Outlet

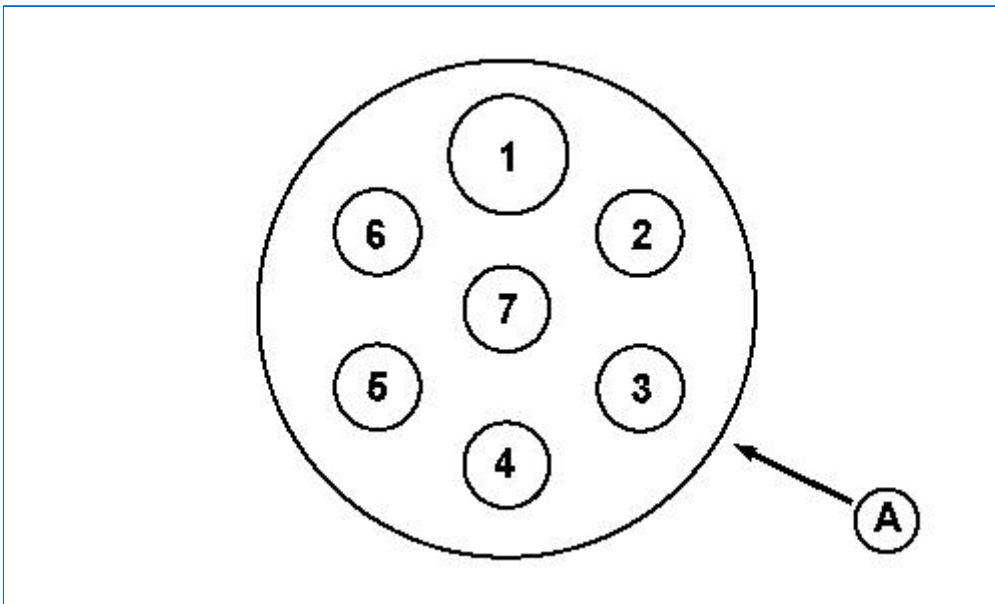

RW21249A-UN: Seven-Terminal Outlet Terminals

**LEGEND:**

A - Seven Terminal Outlet

Outlet (A) is used to connect lights, turn signals, and remote electrical equipment on trailers or implements. Always use auxiliary light on towed implement when tractor rear signals and other lights are obscured.

**NOTE:**

*Matching plug is available through your John Deere Dealer.*

Thank you so much for reading.  
Please click the “Buy Now!”  
button below to download the  
complete manual.



After you pay.

You can download the most  
perfect and complete manual in  
the world immediately.

Our support email:

[ebooklibonline@outlook.com](mailto:ebooklibonline@outlook.com)