

# omar178340 - 8110T, 8210T, 8310T and 8410T Tractors (902001- ) Controlling Air Flow

---

## Controlling Air Flow

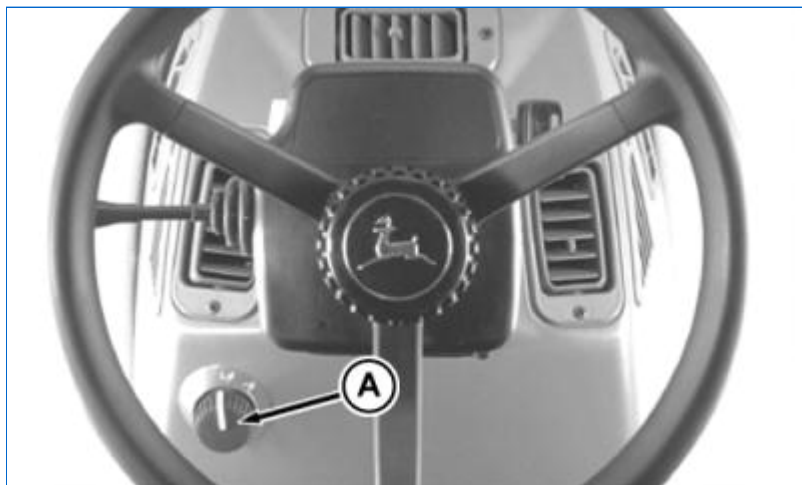

RW55204A-UN: Air Flow Control

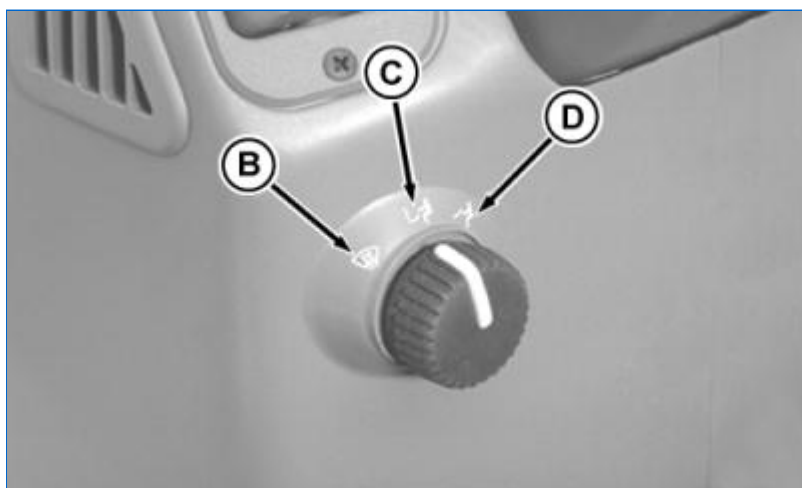

RW55236A-UN: Windshield and Dash Control Positions

### LEGEND:

- A - Air Flow Control
- B - Windshield
- C - Windshield and Dash
- D - Dash

Turn control (A) to direct air flow between windshield and dash or a combination of both.

## omar178340 - 8110T, 8210T, 8310T and 8410T Tractors (902001- ) Adjusting Fan Speed

---

### Adjusting Fan Speed

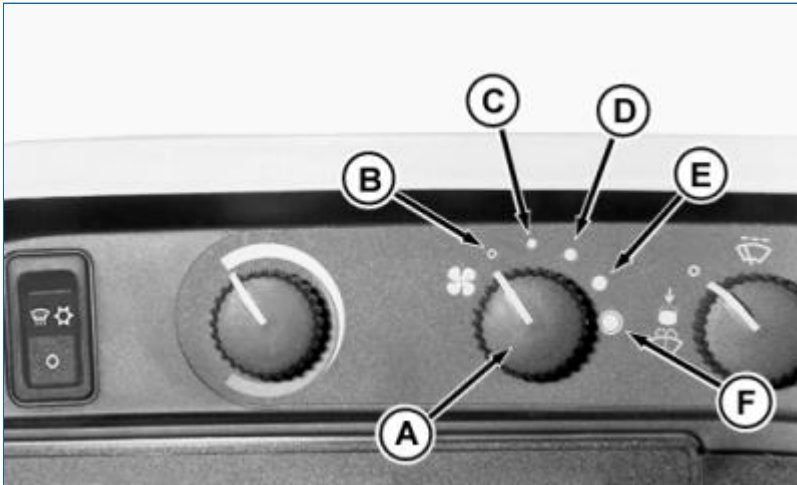

RW26651-UN: Turn Knob to Adjust Fan Speed

#### LEGEND:

- A - Fan Control
- B - Off
- C - Low
- D - Medium
- E - High
- F - Purge

Turn knob (A) to desired fan speed.

#### *NOTE:*

*The purge position is designed to exhaust hot air rapidly from the cab.*

The pressurization blower operates whenever the fan speed switch is in the ON position.

## omar178340 - 8110T, 8210T, 8310T and 8410T Tractors (902001- ) Controlling Temperature

---

### Controlling Temperature

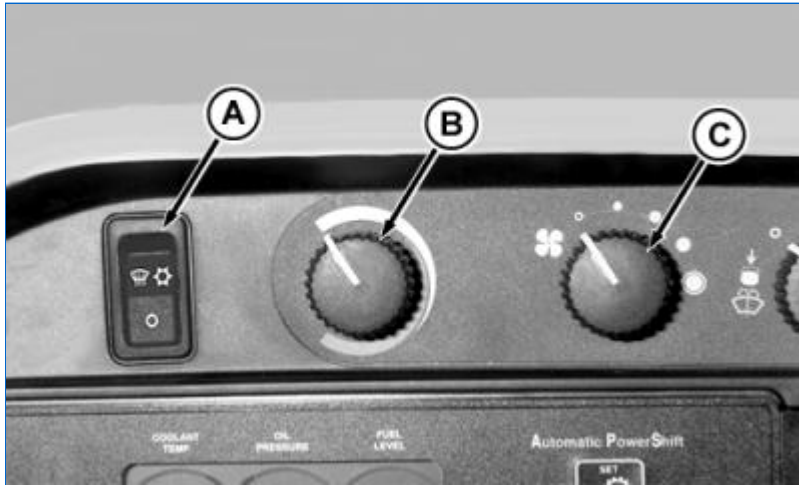

RW26652-UN: Temperature Controls

Fan speed control (C) and air conditioning switch (A) must be in the ON position before the air conditioning system will operate.

Control (B) regulates the heater and defroster temperature.

Put switch (A) in the ON position to defog the windows, and adjust control (B) to desired temperature.

## omar178340 - 8110T, 8210T, 8310T and 8410T Tractors (902001- ) Using ClimaTrak ® Temperature Control- *Optional*

### Using ClimaTrak ® Temperature Control- *Optional*

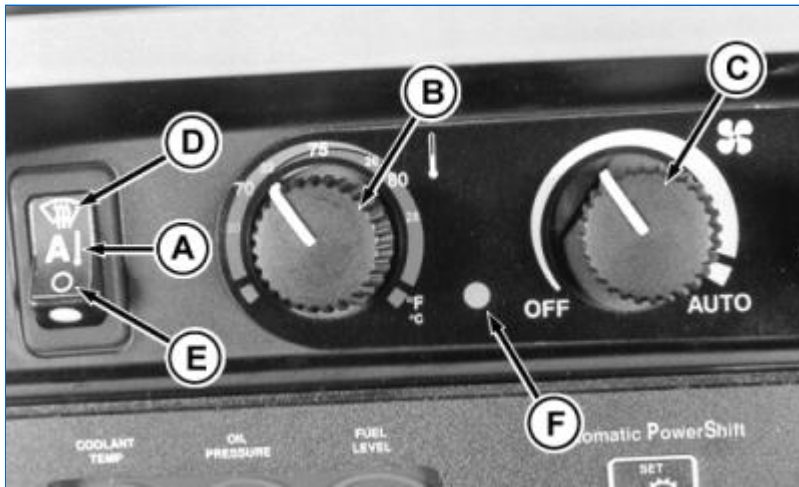

RW26835-UN: Temperature Control Switches

#### LEGEND:

- A - ClimaTrak Control Position
- B - Temperature Control
- C - Fan Speed Control
- D - DEFOG Position
- E - ClimaTrak OFF Position
- F - System Fault Indicator

Set switch to automatic position (A).

Select desired reference temperature by turning control knob (B).

Set fan speed control (C) to AUTO position.

#### *NOTE:*

*Fan speed adjusts automatically in AUTO position. Turning speed control (C) to manual mode settings provides continuous fan speed.*

*Fan continues to operate when switch is in position (E).*

Select DEFOG setting (D) to reduce condensation inside the cab.

#### *NOTE:*

*If fault indicator (F) flashes during operation, see your John Deere Dealer.*

# omar178340 - 8110T, 8210T, 8310T and 8410T Tractors (902001- ) Operating Windshield Wiper

---

## Operating Windshield Wiper

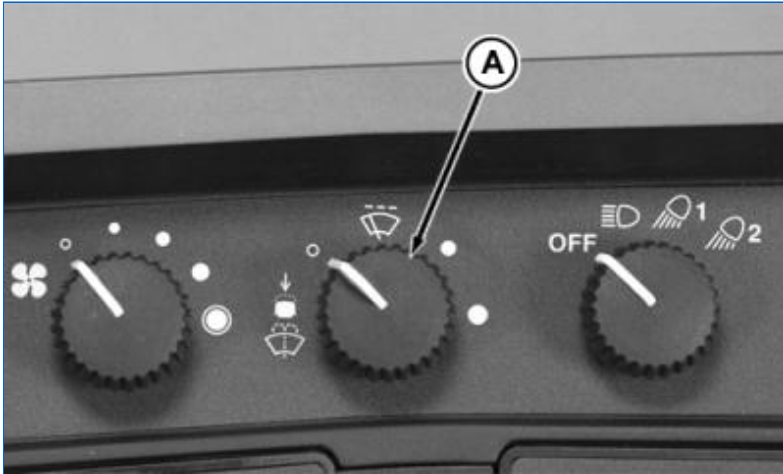

RW26636-UN: Rotate Switch

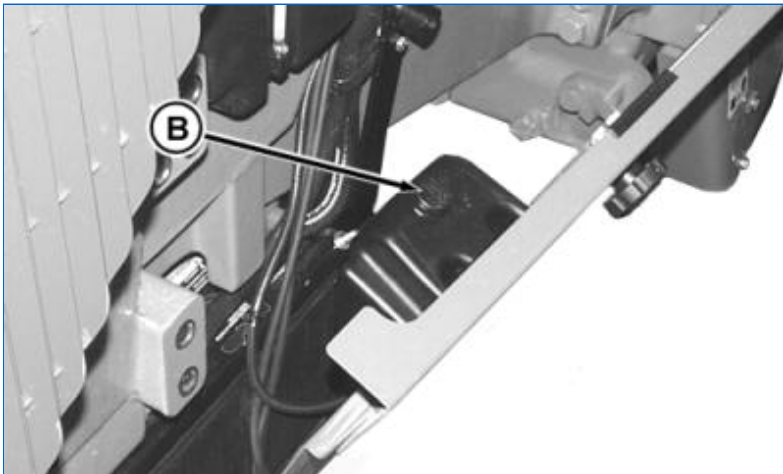

RW26686-UN: Windshield Wash Reservoir

Rotate switch (A) to activate four wiper positions:

- Off
- Intermittent
- Slow
- Fast

Push switch in to operate optional windshield washer.

Fill washer reservoir (B) with non-freezing solvent to prevent damage to washer system in cold temperatures.

Insert a small pin in washer nozzles to adjust direction of spray.

## omar178340 - 8110T, 8210T, 8310T and 8410T Tractors (902001- ) Operating Rear Windshield Wiper and Washer- *Optional*

---

### Operating Rear Windshield Wiper and Washer- *Optional*



RW26207-UN: Rear Windshield Wiper and Washer Switch

Switch (A) has three operating positions:

Top **WASHER** position-hold switch down to activate washer

Center **ON** position-windshield wiper is activated

Bottom **OFF** position

# omar178340 - 8110T, 8210T, 8310T and 8410T Tractors (902001- ) Adjusting Steering Wheel

---

## Adjusting Steering Wheel



RW26609-UN: Telescope and Tilt Adjustments

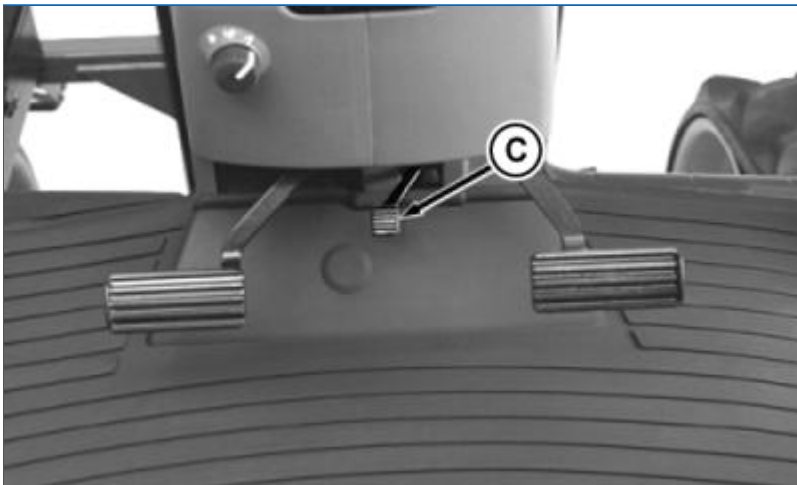

RW56311A-UN: Steering Column Foot Pedal

### Telescope

Rotate knob (A) counter-clockwise to extend or retract the steering wheel. Rotate knob clockwise to lock.

### Tilt

Pull up on lever (B) and move the steering column to the desired position. Release lever to lock.

## Memory

Push down on foot pedal (C) to permit steering column to automatically move up, out of operator's way for easy entry or exit.

Push down on foot pedal and pull down on steering wheel to return steering column back to previous setting.

Thank you so much for reading.  
Please click the “Buy Now!”  
button below to download the  
complete manual.



After you pay.

You can download the most  
perfect and complete manual in  
the world immediately.

Our support email:

[ebooklibonline@outlook.com](mailto:ebooklibonline@outlook.com)