

3950 AND 3970 FORAGE HARVESTERS



JOHN DEERE

OPERATORS MANUAL 3950 AND 3970 FORAGE HARVESTERS

OME77183 H8 English

JOHN DEERE OTTUMWA WORKS

OME77183 H8

(This Manual Replaces OME77183 ISSUE F6)

LITHO IN THE U.S.A.
ENGLISH



Contents

	Page		Page
Safety	05-1	Adjusting Smooth Roll Scraper	35-14
Safety Signs	10-1	Checking Iron-Gard Metal Detector Daily	35-15
Preparing the Tractor	15-1	Operating the IRON-GARD Metal Detector	35-17
Preparing the Harvester		When Metal is Detected	35-17
Harvesting Unit Checklist	20-1	Operating IRON-GARD Metal Detector Lockout	35-18
Adjusting Lift or Lowering Rate of Harvesting Unit	20-2	Replacing Shear Bolts	35-18
Adjusting Electric Downstop	20-2	SPOUT-TRAK™ Aiming Operation	35-19
Changing Fan Speeds	20-3	Field Adjustment for SPOUT-TRAK Aiming	35-20
Selecting Axle Extensions	20-5	Adjusting Spout Rotation for Proper Working Width	35-20
Selecting Wheel Spindle Position	20-6	Operating ROW-TRAK Guidance	35-23
Checking Wheels	20-6	Conditions for Not Operating ROW-TRAK Guidance	35-23
Checking Tire Inflation	20-7	Operating Hydraulic Wagon Disconnect	35-24
Using Tongue Stop Bolt	20-7		
Adjusting Wagon Tongue Clevis	20-8	Attachments	
Attaching and Detaching		Mower Bar Unit	40-1
Attaching Hitch to Drawbar	25-1	Pickup Unit	40-1
Connecting Electrohydraulic Tractor Hookup	25-1	Corn Head Units	40-1
PTO Driveline Dimensions	25-3	Row-Crop Units	40-2
Attaching PTO Driveline (3950)	25-4	SPOUT-TRAK Aiming Control	40-2
Detaching PTO Driveline (3950)	25-4	ROW-TRAK Guidance	40-3
Attaching PTO POWR-GARD Driveline	25-5	Hydraulic Wagon Disconnect	40-3
Detaching PTO POWR-GARD Driveline	25-5	Hydraulic Tongue Positioner	40-3
Transporting		Electric Downstop	40-3
Recommended Warning Lights	30-1	Additional Hydraulic Remote Control Function	40-4
Using Transport Hitch	30-1	Open-Center Conversion	40-4
Preparing for Transport	30-1	Flow Divider Valve	40-4
Towing	30-3	Long Tongue	40-4
Use Safety Lights and Devices	30-3	Short Tongue	40-5
Operating the Harvester		Lighting Kit	40-5
Breaking in the Harvester	35-1	Recutter Screens	40-5
Starting the Harvester	35-1	Recutter Screen Adapting Bundle	40-5
Opening Cutterhead Door and Auger Cover	35-2	Additional Electrohydraulic Control Console	40-6
Sharpening Cutterhead Knives	35-2	PTO Driveline Conversion	40-6
Adjusting Stationary Knife	35-6	Cantilever Cross Auger	40-6
Using Recutter Screen	35-7	Safety Chain	40-6
Adjusting Recutter Screen	35-8	Tractor Axle Guard	40-7
Using Feed Roll Rise Indicator	35-9	Discharge Spout Extensions and Wear Liners	40-7
Selecting Length-of-Cut	35-9	Axle Extensions	40-7
Changing Sprocket for Length-of-Cut	35-10	Transport Wagon Hitch	40-8
Adjusting Fan Belt Tension	35-10	Rope Controlled Wagon Disconnect	40-8
Adjusting Front Feed Rolls	35-11	Lower Feed Roll Pan	40-8
Adjusting Rear Feed Rolls	35-13	Feed Roll Drive Sprocket	40-8
		Control Cable Extension Harness	40-9

Contents

	Page		Page
Upper Front Feed Roll Fillers	40-9	Adjusting Wheel Bearings	55-19
Hydraulic Outlet	40-9	Connecting Ball Slip Hookup	55-20
540 or 1000 RPM Conversion Parts	40-9	Replacing Feed Roll Housing Wear Liners	55-20
Lubrication and Maintenance		Adjusting Auger Drive Chain	55-21
Observe Lubrication Symbols	45-1	Adjusting Length-of-Cut Chain	55-22
Perform Lubrication and Maintenance	45-1	Adjusting Upper and Lower Feed Roll Drive Chains	55-22
Chains	45-1	Care of Chains	55-22
Extreme Pressure Grease	45-2	Replacing Spout Transition Bolts	55-23
Gear Oil	45-2	Servicing Main Drive Gear Case	55-23
Lubrication and Maintenance		Adjusting Spout Motor	55-23
As Required	45-3	Adjusting Spout Alignment for Uniform Wagon Loading	55-24
Every 10 Hours	45-4	Adjusting SPOUT-TRAK Potentiometers	55-24
Every 50 Hours	45-6	Adjusting Tongue Follower Potentiometer	55-26
Every 100 Hours	45-7	Functional Check:	
Annually	45-8	SPOUT-TRAK Aiming	55-27
Troubleshooting		Hydraulic Wagon Disconnect	55-27
Cutterhead and Fan	50-1	Tongue Positioner	55-28
Knife Sharpener	50-7	Electric Downstop	55-28
Stationary Knife Adjustment	50-9	ROW-TRAK Guidance	55-29
Remote Controls	50-10	Storage	60-1
PTO Hookup	50-13	Crime Prevention Tips	65-1
Tongue Difficulties	50-14	Assembly	70-1
Service		Specifications	75-1
Replacing or Adjusting Cutterhead Knives	55-1		
Replacing Knife Sharpening Stone	55-3		
Adjusting Knife Gauge Bar	55-5		
Leveling Knife Sharpener	55-5		
Replacing Knife Retainer Bar	55-6		
Removing Stationary Knife	55-7		
Installing Stationary Knife	55-8		
Correcting Knife Adjuster End Play	55-10		
Checking Stationary Knife for Wear	55-12		
Replacing Smooth Roll Scraper	55-13		
Adjusting Lower Stop Pawl	55-14		
Adjusting Upper Stop Pawl	55-14		
Replacing Hydraulic Cylinder	55-15		
Adjusting Fan Blades	55-16		
Replacing Fan Blade and Fan Blade Bolts	55-16		
Adjusting Force to Shift Feed Rolls	55-17		
Adjusting Slip Clutch Alert	55-17		
Adjusting SPOUT-TRAK Aiming Magnetic Pickup	55-18		
Adjusting Neutral Stop Switch (Metal Detector Only)	55-18		
Adjusting Feed Roll Springs	55-19		
Tightening Bearing Locking Collars	55-19		

Safety

RECOGNIZE SAFETY INFORMATION

This is the safety-alert symbol. When you see this symbol on your machine or in this manual, be alert to the potential for personal injury.

Follow recommended precautions and safe operating practices.

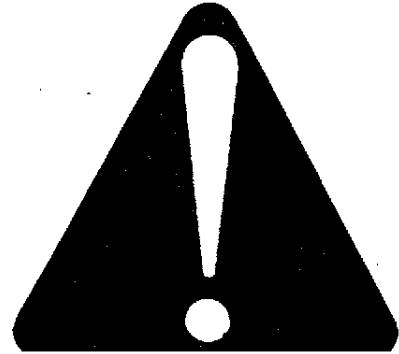

AB6;T81389 053;ALERT 160687

UNDERSTAND SIGNAL WORDS

A signal word—DANGER, WARNING, or CAUTION—is used with the safety-alert symbol. DANGER identifies the most serious hazards.

Safety signs with signal word DANGER or WARNING are typically near specific hazards.

General precautions are listed on CAUTION safety signs. CAUTION also calls attention to safety messages in this manual.



AB6;TS187 053;SIGNAL 071085

FOLLOW SAFETY INSTRUCTIONS

Carefully read all safety messages in this manual and on your machine safety signs. Keep safety signs in good condition. Replace missing or damaged safety signs.

Learn how to operate the machine and how to use controls properly. Do not let anyone operate without instruction.

Keep your machine in proper working condition. Unauthorized modifications to the machine may impair the function and/or safety and affect machine life.

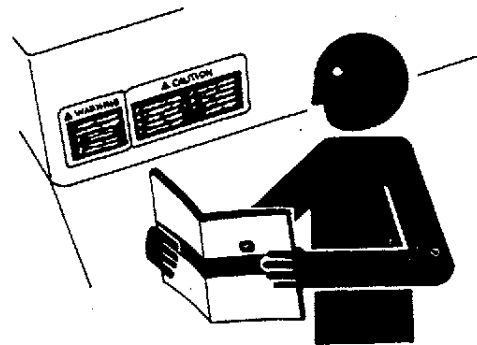

AB6;TS201 053;READ 230487

OPERATE FORAGE HARVESTER SAFELY

All machinery must be operated by responsible persons who have been properly instructed and delegated to do so.

Never stand under discharge spout while harvester is operating.

Always operate machine at rated PTO speed.



AB6;TS263 E03;3970C -U 220888



CLEAN HARVESTER SAFELY

To avoid injury or death:

Disengage drives and shut off engine before attempting to unplug the harvesting unit or machine. The feed rolls can feed crop material faster than you can release your grip on the material.

Never use your hands or feet to feed crop into the forage harvester, with or without a harvesting unit.

This forage harvester is intended for mobile field operation only. Never use or modify machine to be used in a stationary operation.



085;E32293 E03;3970C -V 220888

KEEP RIDERS OFF MACHINE

Only allow the operator on the machine. Keep riders off.

Riders on machine are subject to injury such as being struck by foreign objects and being thrown off of the machine. Riders also obstruct the operator's view resulting in the machine being operated in an unsafe manner.

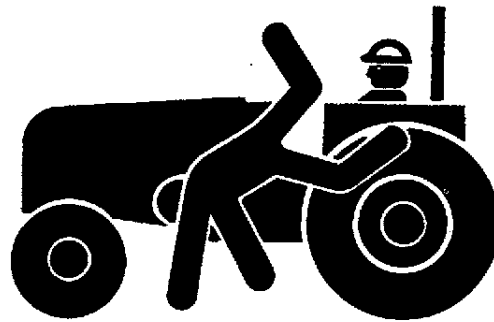

AB6;TS213 053;RIDER 160687

PREPARE FOR EMERGENCIES

Be prepared if a fire starts.

Keep a first aid kit and fire extinguisher handy.

Keep emergency numbers for doctors, ambulance service, hospital, and fire department near your telephone.

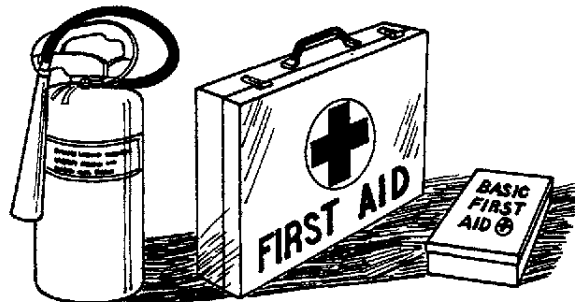

AB6;TS186 053;FIRE2 060785



WEAR PROTECTIVE CLOTHING

Wear close fitting clothing and safety equipment appropriate to the job.

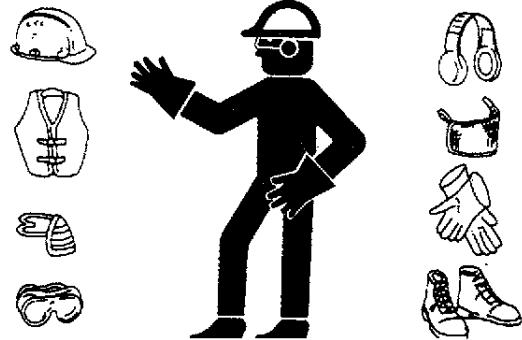

AB6;TS206 053;WEAR2 230487

PROTECT AGAINST NOISE

Prolonged exposure to loud noise can cause impairment or loss of hearing.

Wear a suitable hearing protective device such as earmuffs or earplugs to protect against objectionable or uncomfortable loud noises.

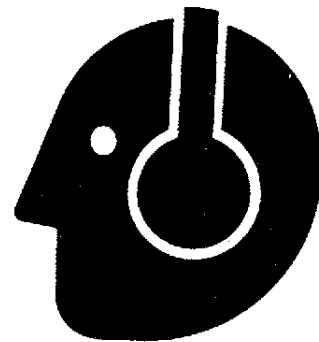

AB6;TS207 053;NOISE 230487

STAY CLEAR OF ROTATING DRIVELINES

Entanglement in rotating driveline can cause serious injury or death.

Keep tractor master shield and driveline shields in place at all times. Make sure rotating shields turn freely.

Wear close fitting clothing. Stop the engine and be sure PTO driveline is stopped before making adjustments, connections, or cleaning out PTO driven equipment.



AB6;TS198 053;PTO 160687

USE SAFETY LIGHTS AND DEVICES

Flashing warning lights and turn signals are recommended when towing this equipment on public roads unless prohibited by state or local regulations. A safety lighting kit is available from your John Deere dealer.

Keep safety items in good condition. Replace missing or damaged items.

- A—Lights
B—Slow Moving Vehicle Emblem
C—Reflector Tape
D—Reflectors

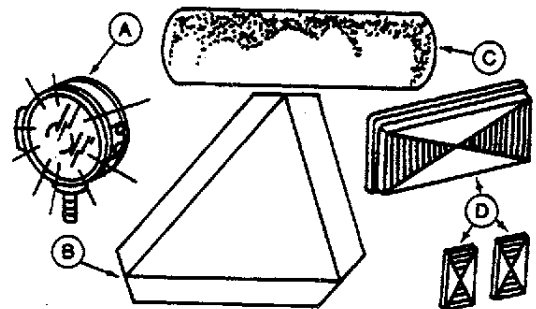

AB6;N36564 053;FLASH C10388



USE A SAFETY CHAIN

A safety chain will help control drawn equipment should it accidentally separate from the drawbar.

Using the appropriate adapter parts, attach the chain to the tractor drawbar support or other specified anchor location. Provide only enough slack in the chain to permit turning.

See your John Deere dealer for a chain with a strength rating equal to or greater than the gross weight of the towed machine. Do not use safety chain for towing.

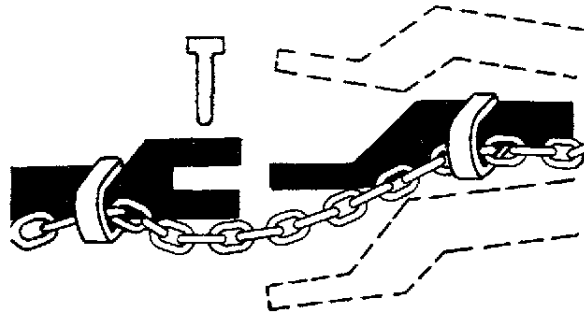

AB6;TS217 053;CHAIN 171287

REDUCE SPEED WHEN TOWING LOADS

Braking to stop towed loads from transport speeds can cause the towed load to swerve and upset. Reduce speed if towed load weighs more than the tractor and is not equipped with brakes.

Follow recommended speed-weight ratio guidelines:

- Maximum speed is 20 mph (32 km/h) when towing load equal to or less in weight than the tractor.
- Reduce speed to 10 mph (16 km/h) when towing load up to double the tractor weight.
- Do not tow loads exceeding double the tractor weight.
- Use additional caution when towing loads under adverse surface conditions, when turning, and on inclines.

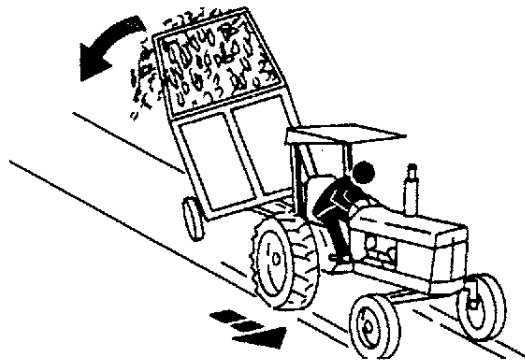

AB6;TS216 053;TOW 080688



PRACTICE SAFE MAINTENANCE

Understand service procedure before doing work. Keep area clean and dry.

Never lubricate or service machine while it is moving. Keep hands, feet, and clothing from power-driven parts. Disengage all power and operate controls to relieve pressure. Lower equipment to the ground. Stop the engine. Remove the key. Allow machine to cool.

Securely support any machine elements that must be raised for service work.

Keep all parts in good condition and properly installed. Fix damage immediately. Replace worn or broken parts. Remove any buildup of grease, oil, or debris.

Disconnect battery ground cable (-) before making adjustments on electrical systems or welding on machine.



AB6;TS218 053;SERV 211287

On machines with ROW-TRAK guidance, avoid being knocked down or crushed by unexpected movement of machine.

Be sure ELECTRICAL POWER is OFF before servicing or unplugging.

If a stalk, leg, hand, or other objects contact the ROW-TRAK sensor when power is on, the machine will move.

Be especially careful in the area between the row-crop and tongue.

E03;;3970C G 090586

AVOID HIGH-PRESSURE FLUIDS

Escaping fluid under pressure can penetrate the skin causing serious injury. Relieve pressure before unhooking hydraulic or other lines. Tighten all connections before applying pressure. Keep hands and body away from pinholes and nozzles which eject fluids under high pressure. Use a piece of cardboard to search for leaks.

If ANY fluid is injected into the skin, it must be surgically removed within a few hours by a doctor familiar with this type injury or gangrene may result.

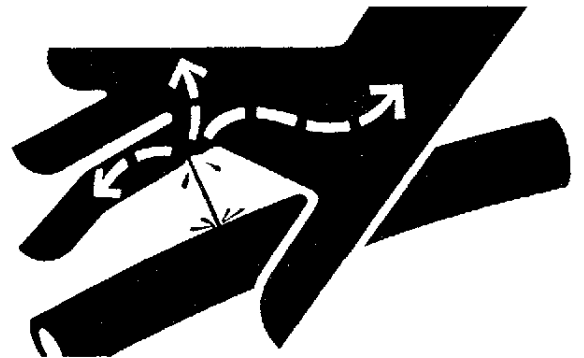

AB6;X9811 053;FLUID 180987

Safety Signs

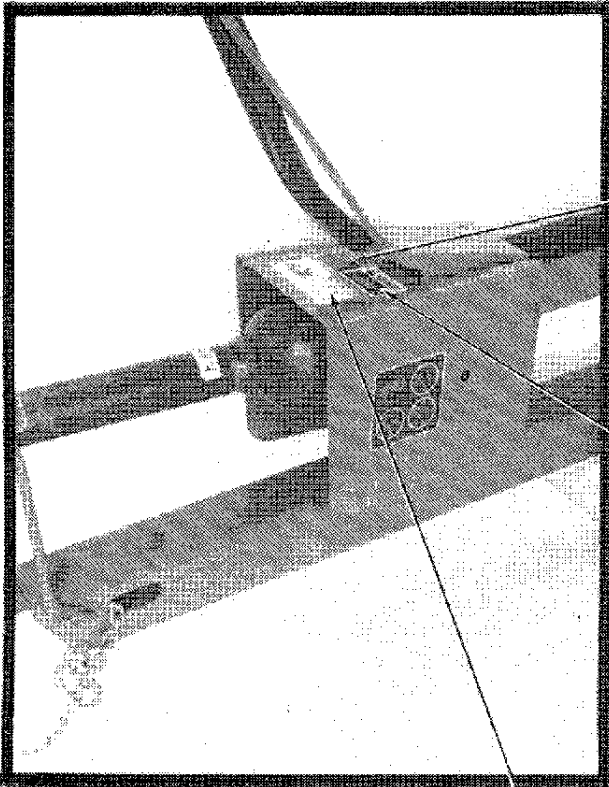

⚠ WARNING

To avoid bodily injury,
keep all power drive
system safety shields
in place.
Operate only with
1000 rpm PTO.

5

⚠ WARNING

To avoid bodily injury,
Make sure PTO hookup is securely
connected and pedestal shield is
closed before engaging PTO.

40

⚠ DANGER



Entanglement in rotating
driveline can cause serious
injury or death.

Keep all shields in place.
Avoid contact with rotating
parts.

014;E27619 E03;;3970Z A 090586



WARNING

Components behind guards or access doors in this area may rotate, possibly several minutes after power is shut off.

To avoid bodily injury:

1. Look and listen for evidence of rotation.
2. Do not open or remove guard or access door until all components have stopped.

A0

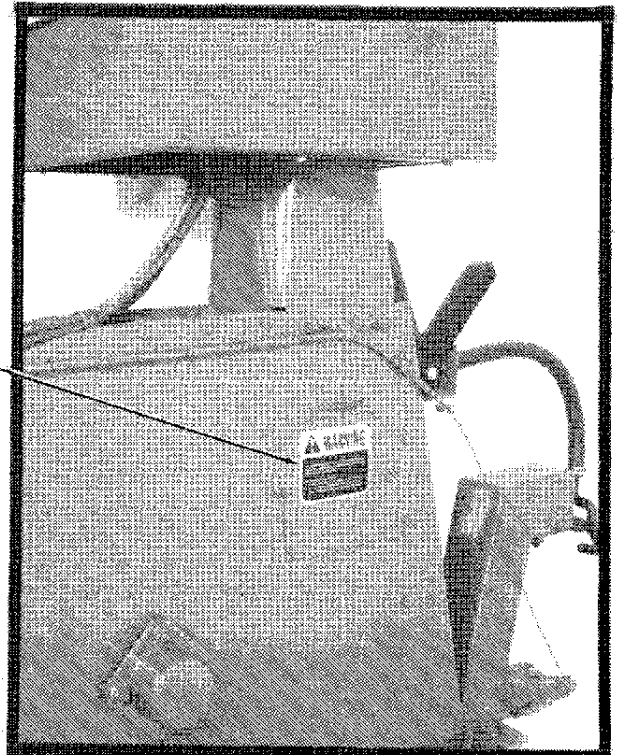

614/E27620 E03;39702 B 090586

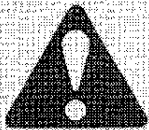

WARNING

Components behind guards or access doors in this area may rotate, possibly several minutes after power is shut off.

To avoid bodily injury:

1. Look and listen for evidence of rotation.
2. Do not open or remove guard or access door until all components have stopped.

A0

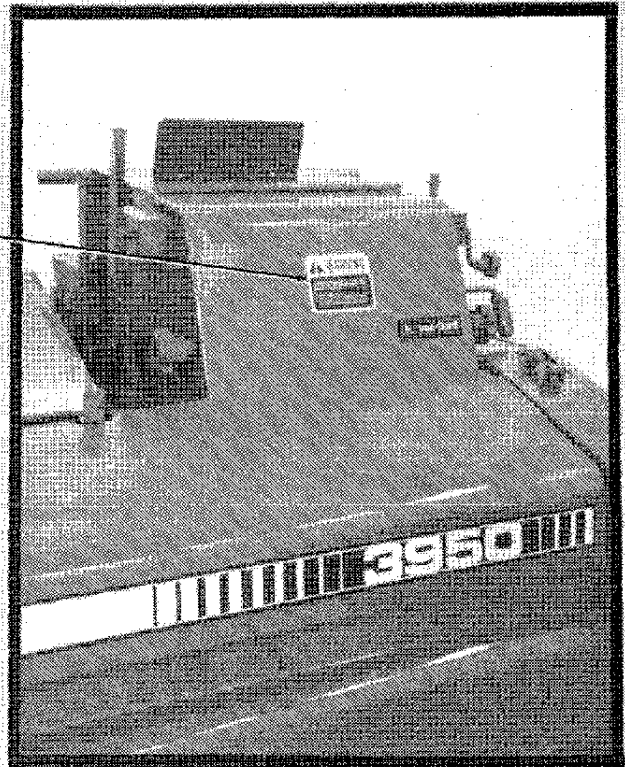

614/E27621 E03;39702 C 090586



WARNING

Components behind guards or access doors in this area may rotate, possibly several minutes, after power is shut off.

To avoid bodily injury:

1. Look and listen for evidence of rotation.
2. Do not open or remove guard or access door until all components have stopped.

AD

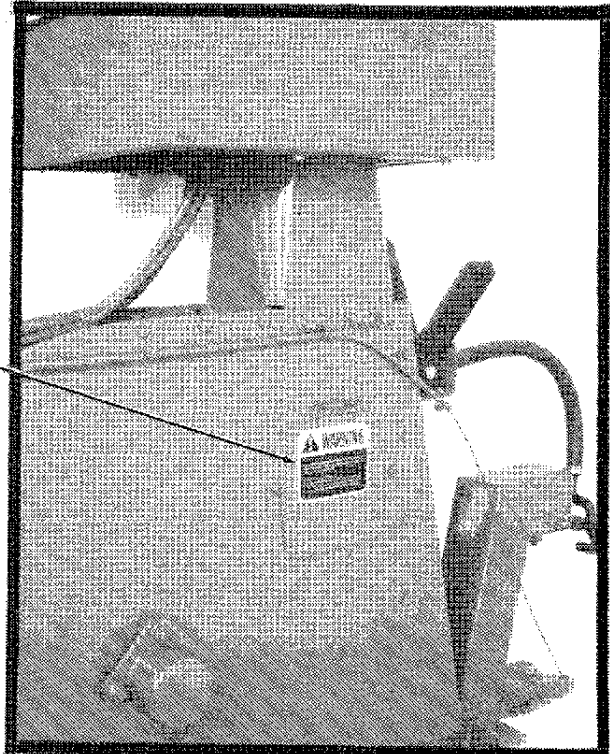

014;E27620 E03;39702 B 090586

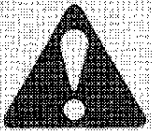

WARNING

Components behind guards or access doors in this area may rotate, possibly several minutes, after power is shut off.

To avoid bodily injury:

1. Look and listen for evidence of rotation.
2. Do not open or remove guard or access door until all components have stopped.

AD

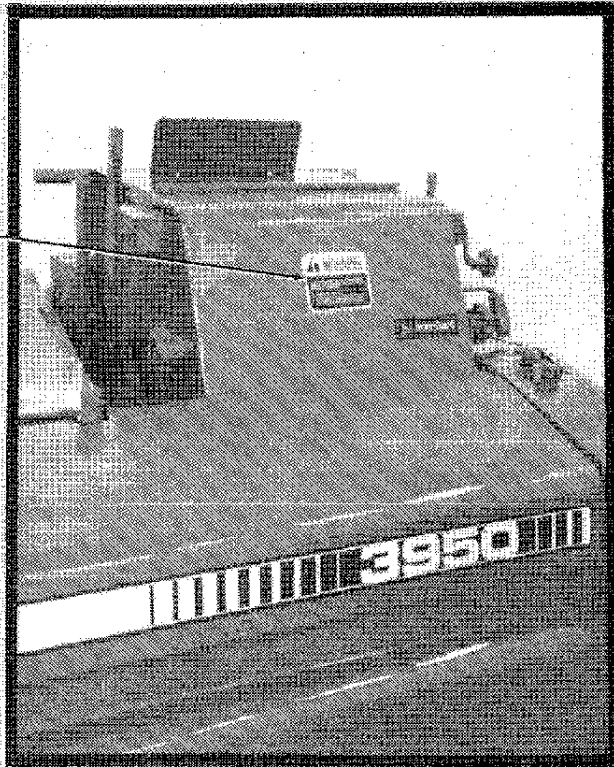

014;E27621 E03;39702 C 090586

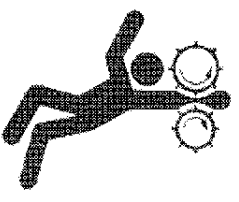

⚠ DANGER

Avoid death or serious injury from entanglement in the feed rolls.

The harvester takes crop faster than you can release it.

NEVER feed with hands or feet or use as a manually fed stationary machine.

Disengage drives and shut off engine before manually unplugging.

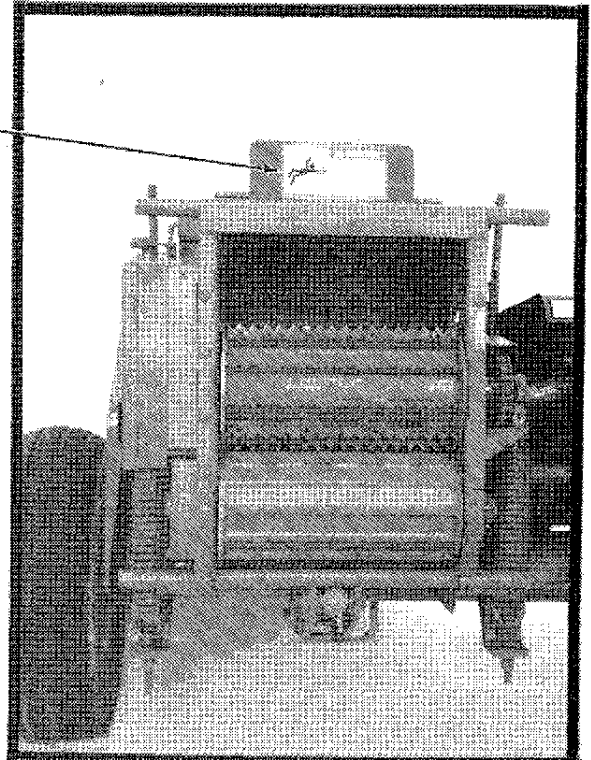

014:E27623 E03:3970Z E 090586

⚠ WARNING

To avoid bodily injury,
keep all power drive
system safety shields
in place.
Operate only with
1000 rpm PTO.

S

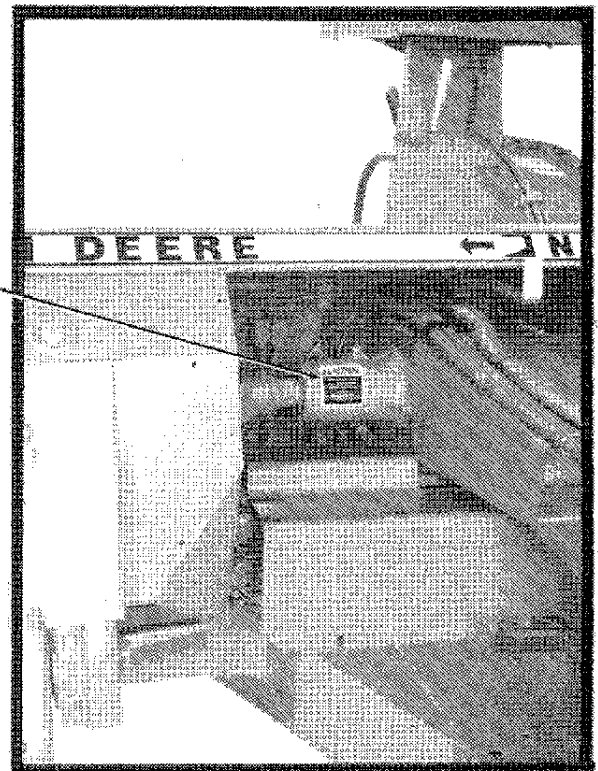

014:E27624 E03:3970Z F 090586

Preparing the Tractor

ADJUSTING TRACTOR DRAWBAR

The harvester can be attached to any tractor having a drawbar and PTO that conforms to ASAE-SAE standards. The tractor must have a PTO speed of 540 or 1000 rpm to match the powershaft speed of the harvester.

The tractor tire inflation pressures specified in the tractor operator's manual will apply.

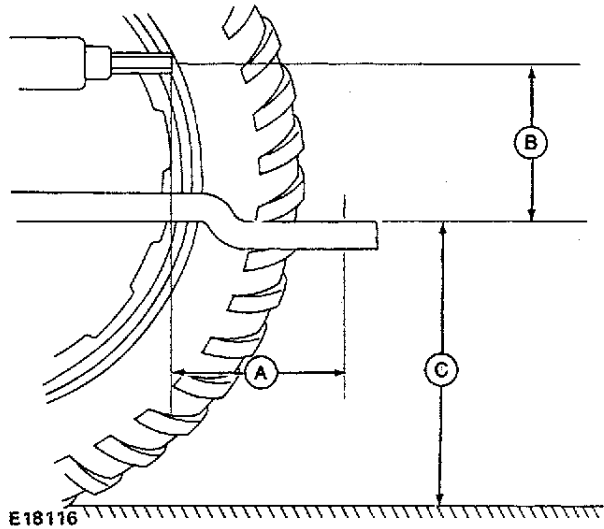

540 RPM PTO SIZE	A In. (mm)	B In. (mm)	C In. (mm)
1-3/8 in.	14 (355)	6-12 (152-305)	13-17 (330-432)
1000 RPM PTO SIZE			
1-3/8 in.	16 (406)	6-12 (152-305)	13-17 (330-432)
1-3/4 in.	20 (508)	6-12 (152-305)	13-17 (330-432)

Align drawbar hitch pin hole vertically with center-line of tractor PTO.

- A—End of PTO Shaft to Hitch Pin Hole
- B—Center of PTO Shaft to Top of Drawbar
- C—Top of Drawbar to Ground

AA7;E18116 E03;3970V A 060684

CHECKING HITCH STRAP

IMPORTANT: Never operate 540 rpm harvester with 1000 rpm tractor.

The hitch strap has been preset at the factory and bolts torqued to 260 lb-ft (35 N·m). Recheck bolts for proper location.

- 1000 rpm—Bolts should be in front set of holes (A).
- 540 rpm—Bolts should be in rear set of holes (B).

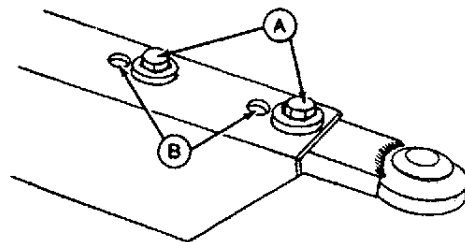

AA7;E23806 E03;3970V B 060684

Preparing the Harvester

HARVESTING UNIT CHECKLIST

To assure the best machine performance, review the following checklist BEFORE attaching harvesting unit to harvester.

NOTE: All harvesting units used on 3950 and 3970 Forage Harvesters must be equipped with a properly adjusted slip clutch to prevent overload damage to harvesting unit. All 40 Series Ear Corn Heads have individual row unit slip clutch protection.

		Row Crops	Pickups	Ear Corn Heads	Mower Bar
Wheel Spindles See Selecting Wheel Spindle Position, this section	Down Middle	X	X	X	X
Axle Extensions See Selecting Axle Extensions, this section	Installed Removed	X	X	X	X
Fan Speed See Changing Fan Speeds, this section	Fast Slow	X	X	X	X
Rear Feed Roll Clearance See Adjusting Rear Feed Rolls in Operating the Harvester section	1/16 in. (1.59 mm) 1 in. (25 mm)	X	X	X	X
Tongue Stop Bolt See Using Tongue Stop Bolt, this section	Installed Removed	X*	X**	X*	X
Lower Feed Roll Pan See Install Lower Feed Roll Pan in Assembly section	Installed Removed	X***	X	X	X
Recutter Screen and Supports See Install Recutter Screen and Supports in Assembly section	Installed Removed	# X	# # X	X	X
****Anti-Carryover Deflector See Install Anti-Carryover Deflector in Assembly section	Installed Removed			X	
Higher Feed Roll Downstops See Adjusting Front Feed Rolls in Operating the Harvester section	Installed Removed	X	X	X	X
Lift Cylinder and Lock-Out Plate See Replacing Hydraulic Cylinder in Service section	Installed Removed			343 Only	

- * 3-Row Row-Crops and 3-Row Corn Heads Only
- ** 7 Ft. (2134 mm) Pickup Only
- *** Dry Grain Only
- **** Use Anti-Carryover Deflector when using recutter screens
Deflector need not be removed from machine when recutter screens are removed.
- # Extremely dry material may require screen.
- # # To eliminate irregular lengths of crop it may be necessary to use recutter Screen.

E03;39701 -A 220888

ADJUSTING LIFT OR LOWERING RATE OF HARVESTING UNIT

It may be necessary to adjust the lift or lowering rate of the harvesting unit because of weight differences of harvesting units.

IMPORTANT: Excessively fast lift or lowering rates can cause severe damage to the machine frame and hydraulic system and should be avoided.

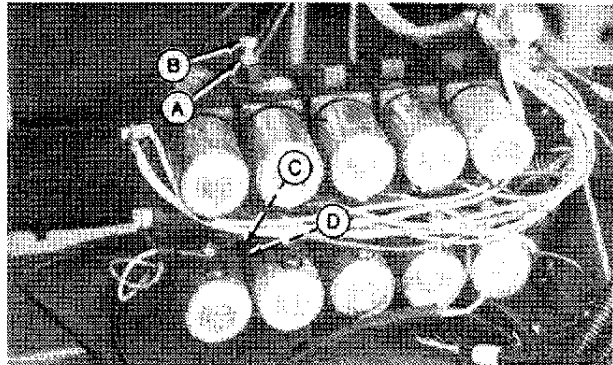

To adjust lowering rate, loosen jam nut (A) and turn adjusting screw (B) clockwise to slow the drop rate; counterclockwise to make drop rate faster. When desired rate of drop is achieved, tighten jam nut.

To adjust lift rate, loosen jam nut (C) and turn adjusting screw (D) clockwise to slow the lift; counterclockwise to make lift rate faster. When desired rate of lift is met, tighten jam nut securely.

- A—Jam Nut
- B—Adjusting Screw
- C—Jam Nut
- D—Adjusting Screw

014;E23561 E03;;39701 B 090586

ADJUSTING ELECTRIC DOWNSTOP

Move downstop lever (A) forward toward position (1) to lower harvesting unit, or move lever (A) toward position (9) to raise harvesting unit.

NOTE: When machine is NOT in use, raise the harvesting unit and engage the lift cylinder stop to its locked position (not illustrated) or lower the harvesting unit to the ground.

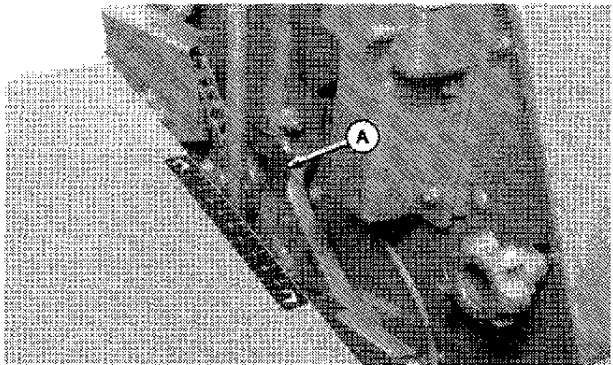

014;E27662 E03;;39701 C 090586

CHANGING FAN SPEEDS

The harvester is equipped with a two speed fan drive. The higher speed (1000 rpm) is used for hard to blow material such as haylage. This speed is obtained with the larger sheave on the cutterhead shaft (A).

The low speed fan (722 rpm) is used for easy to blow materials such as corn silage and is obtained with the larger sheave on the fan shaft (B).

NOTE: Use of the low speed fan may result in as much as one gear faster operation.

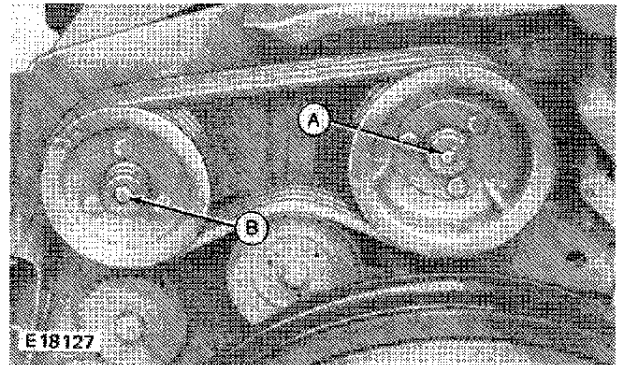

AA7;E18127 E03;;3970I N 060684

1. Open auger door (A) and block fan from rotating as shown.

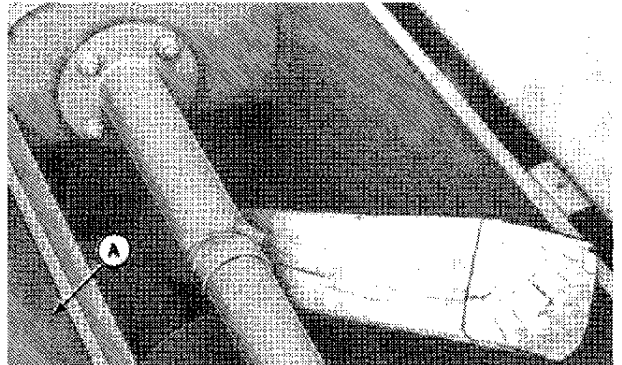

014;E27618 E03;;3970I N 090586

2. Loosen three 5/8-in. bolts (A) on both fan sheaves. Do NOT loosen center bolt at either location.

3. Loosen jam nut (B) on spring tensioning bolt.

4. Remove spring pin and drilled pin from front of spring anchor channel (C) to release idler from spring.

5. Remove three 5/8-in. bolts from one sheave, slide sheave outward slightly to clear shoulder on hub and remove from machine. Repeat on second sheave.

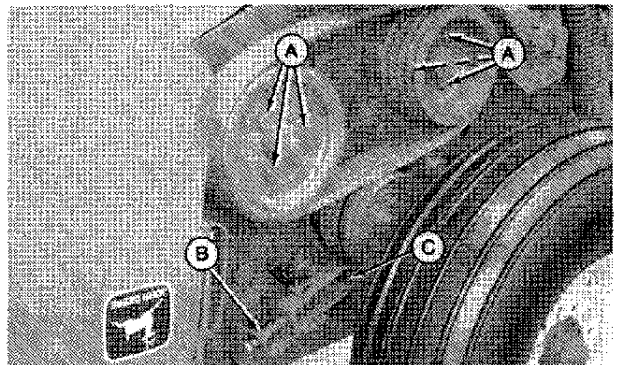

AA7;E23573 E03;;3970I O 060684

Preparing the Harvester

6. Install proper sheave (A) on cutterhead shaft first with belt in grooves of sheave.

NOTE: Sheaves must be turned inside out from original location on opposite shaft.

7. Install three 5/8-in. bolts and tighten finger tight.

8. Insert second sheave (B) into belt and align with belt grooves. Move belt and sheave together to rear and onto hub of shaft. Install three 5/8-in. bolts and tighten finger tight.

9. Lift idler sheave up to belt and reconnect idler arm to tension spring (C) with drilled pin and spring pin removed in step 4.

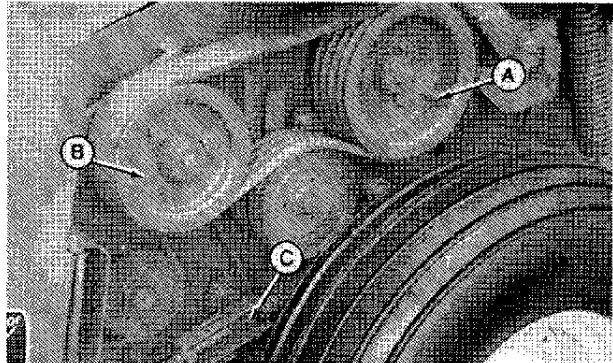

AA7;E23574 E03;39701 P 060684

10. Watching belt tension indicator (A), tighten or loosen spring tensioning bolt (B) until indicator on spring tensioning channel (C) matches the position of the belt tension indicator.

11. After indicators match, tighten jam nut (D).

12. Torque six 5/8-in. bolts securing both sheaves to hub to 185 lb-ft (251 N·m). Remove block from fan.

13. Run harvester for a few minutes to "seat" belt, then recheck the indicators to be sure belt is properly adjusted. Readjust if necessary.

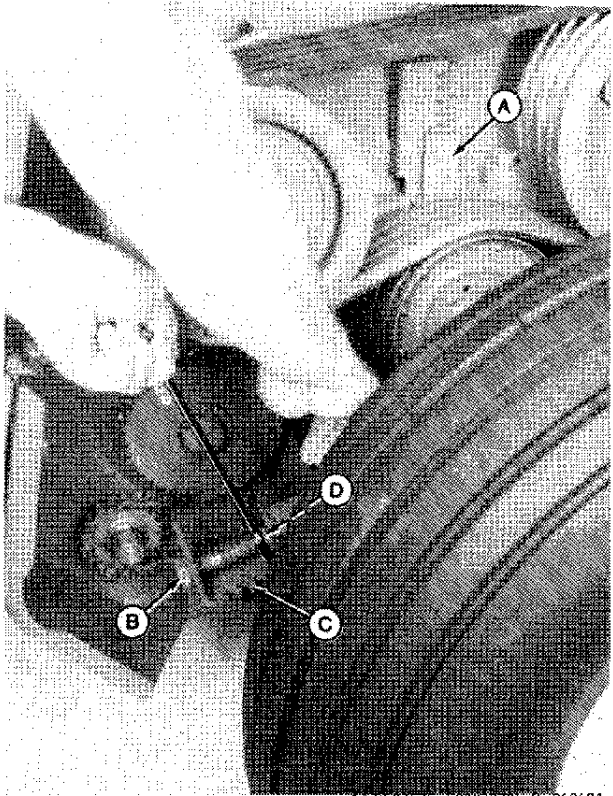

A—Belt Tensioning Indicator
B—Spring Tensioning Bolt
C—Spring Tensioning Channel
D—Jam Nut

AA7;E23575 E03;39701 Q 060684

SELECTING AXLE EXTENSIONS

Axle extensions are available for use with the individual harvesting units shown.

Either or both wheels may be reversed to allow proper aligning for various row spacings.

NOTE: Both wheel spindles must be in the same position to keep harvester level.

	30 in. (762 mm) Rows		38 in. (965 mm) Rows	
	Left-Hand Wheel	Right-Hand Wheel	Left-Hand Wheel	Right-Hand Wheel
1-Row Ear Corn (3950 only)	13-in. (330 mm)	None	None	None
1-Row Row-Crop	13-in. (330 mm)	None	None	None
2-Row Row-Crop	6-in. (152 mm)	None	None	13-in. (330 mm)
2-Row Ear Corn	6-in.* (152 mm)	6-in.* (152 mm)	13-in. (330 mm) 13-in.* (330 mm)	13-in.* (330 mm)
3-Row Row-Crop	13-in. (330 mm) +6-in. (152 mm)	13-in. (330 mm) +6-in. (152 mm)	13-in. (330 mm)	13-in. (330 mm) +13-in. (330 mm)
3-Row Ear Cron (3970 only)	+13-in.* (330 mm) +6-in. (152 mm)	+13-in.* (330 mm) +6-in. (152 mm)	None	None

* = Vertical Offset Extension

E03;3970I R 110686

Thank you so much for reading.
Please click the “Buy Now!”
button below to download the
complete manual.



After you pay.

You can download the most
perfect and complete manual in
the world immediately.

Our support email:

ebooklibonline@outlook.com