

**787
AIR SEEDING
SYSTEM
(SERIAL NO.
NO0787X000925-)**



JOHN DEERE

**OPERATORS MANUAL
787 AIR SEEDING SYSTEM (SERIAL
NO. NO0787X000925-)**

OMN200472 J4 English

**JOHN DEERE DES MOINES WORKS
OMN200472 J4**

LITHO IN THE U.S.A.
ENGLISH



Introduction

READ THIS MANUAL carefully to learn how to operate and service your machine correctly. Failure to do so could result in personal injury or equipment damage.

THIS MANUAL SHOULD BE CONSIDERED a permanent part of your machine and should remain with the machine when you sell it.

MEASUREMENTS in this manual are metric with the customary U.S. measurement following.

RIGHT-HAND AND LEFT-HAND sides are determined by facing in the direction of forward travel.

WRITE PRODUCT IDENTIFICATION NUMBERS in the Specifications section. Accurately record all the numbers to help in tracing the machine should it be stolen. Your dealer also needs these numbers when you order parts. If this manual is kept on the machine, also file the identification numbers in a secure place off the machine.

WARRANTY is provided as part of John Deere's support program for customers who operate and maintain their equipment as described in this manual. The warranty is explained on the warranty certificate which you should have received from your dealer.

This warranty provides you the assurance that John Deere will back its products where defects appear within the warranty period. In some circumstances, John Deere also provides field improvements, often without charge to the customer, even if the product is out of warranty. Should the equipment be abused, or modified to change its performance beyond the original factory specifications, the warranty will become void and field improvements may be denied. Setting fuel delivery above specifications or otherwise overpowering machines will result in such action.

THE TIRE MANUFACTURER'S warranty supplied with your machine may not apply outside the U.S.

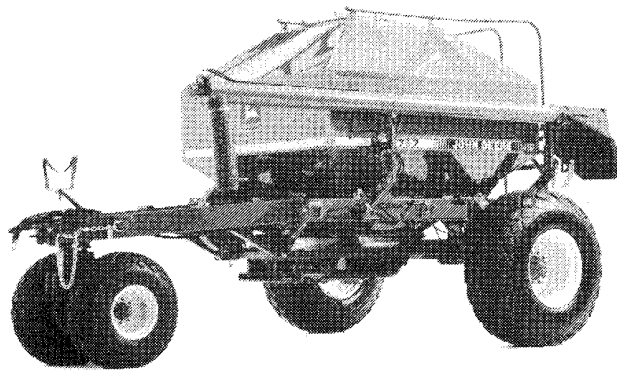

787 Tow-Behind Seed Cart

N43921 -UN-28OCT91

Contents

	Page		Page
Safety	05-1	Measuring Product Density	20-19
Safety Signs	10-1	Using Front and Rear Tanks	20-20
Preparing the Tractor		Adjusting Plenum Dampers and Manifold Valves (Double Shoot)	20-21
Determining Tractor Requirements	15-1	Setting Meter Rate	20-22
Tractor Hydraulic System Requirements	15-2	Product Listing	20-23
Securing 3-Point Hitch	15-3	Rate Charts	
Adjusting Metering Valves	15-3	Fine Roller	20-24
Install Lever Lock Clip	15-3	Coarse Roller	20-34
Positioning Drawbar	15-4	Calculating Equivalent Rate (Air Velocity) . . .	20-44
Convenience Outlet—55 and 60 Series Tractors	15-5	Using Air Velocity Chart	20-45
Checking Monitor and Switch Unit	15-6	Air Velocity Chart	
Preparing the Machine		11-51-0 Fertilizer	20-46
Check Tire Pressure—Air Seeder Cart	20-1	46-0-0 Fertilizer	20-47
Checking Wheel Attaching Hardware and Bearings	20-1	Wheat	20-48
Clean Fan Screen	20-1	Canola	20-49
Changing Tillage Equipment	20-2	Lentils	20-50
Determine Sprocket Set Ratio	20-3	Peas	20-51
Setting Single/Double Shoot Manifold Valve	20-4	Preparing and Operating Monitor	
Checking Air Dampers and Manifold Valves—Single Shoot	20-4	Identifying Monitor Switches	25-1
Checking Air Manifolds, Meter Boxes and Rollers	20-5	Identifying Monitor Displays	25-2
Preparing To Operate Auger	20-9	Monitor	
Adjusting Product Divider Blades	20-10	Preparing	25-3
Understanding Meter Settings	20-11	Start-Up	25-5
Using Pounds of Seed Per Acre Chart	20-13	Preparing—Units of Measure	25-6
Pounds of Seed Per Acre—Soybeans	20-15	Preparing—Implement Width	25-7
Seeds Per Foot of Row—Soybeans	20-15	Determining Ground Speed Value—Field Calibration	25-8
Pounds of Seed Per Acre For Desired Plants Per Acre—Sunflowers	20-16	Preparing Monitor	
Adjusting For Seed		Speed Calibration Value	25-9
Germination—Soybeans and Sunflowers	20-16	Confirming Bin Depth Value	
Determining Meter Rate Setting	20-17	Front	25-10
Confirming Meter Rate Setting	20-18	Rear	25-10
		Calibrating Bin Level Indicators	25-11
		Understanding Air Flow Alarms	25-11
		Disabling/Enabling Air Flow Alarms	25-12
		Preparing Monitor	
		Single/Double Shoot	25-13
		Tow-Between/Tow Behind	25-14

Continued on next page

All information, illustrations and specifications in this manual are based on the latest information available at the time of publication. The right is reserved to make changes at any time without notice.

OMN200472 J4-19-16AUG94

COPYRIGHT® 1994
DEERE & COMPANY
Moline, Illinois
All rights reserved
A John Deere ILLUSTRATION™ Manual

Contents

	Page		Page
Adjusting Air Flow Alarm Set Point—Double or Single Shoot		Attaching and Detaching	
Front	25-15	Attaching	
Rear	25-15	Machine to Tractor (Seeding Tool or Tow Between Cart)	30-1
Disabling Alarms	25-16	Air Seeder to Seeding Tool (Tow Behind Cart)	30-4
Disabling/Enabling		Hand Signals	30-7
Front Alarm	25-16	Attaching Seeding Tool to Air Seeder (Tow Between Cart)	30-8
Rear Alarm	25-17	Connecting Remote Seeder Switch	
Setting Fan Speed Alarm Threshold		Wiring—Tow Between Cart	30-10
High	25-18	Connecting Disk Lowering Solenoid	
Low	25-19	Wiring (730 Air Disk Drill)	30-11
Monitoring Product Application Rates	25-20	Raising and Lowering Parking	
Disabling/Enabling		Stands—730 Air Disk Drill	30-11
Front Application Rate (Delivery) Alarm ...	25-21	Opening and Closing Transport Lock-Up	
Programming Monitor For Application Rate Display		Valve—730 Air Disk Drill	30-12
Front Product Type	25-22	Checking Depth Control Operation	30-12
Front Product Density	25-22	Checking Fan Operation	30-13
Adjusting Rate Display—Front	25-23	Setting Fold/Marker Selector Valve—730 Air Disk Drill	30-14
Front Roller Type	25-23	Checking Wing Fold Operation	30-15
Front Number of Runs	25-24	Detaching Machine From Tractor	30-16
Calculating Rate Display Setting	25-24		
Disabling/Enabling Rear Application Rate (Delivery) Alarm	25-25	Transporting	
Programming Monitor for Application Rate Display		Attach Safety Chain to Tractor	35-1
Rear Product Type	25-26	Using Warning Lights	35-1
Rear Product Density	25-26	Keep Riders Off Machine	35-1
Adjusting Rate Display—Rear	25-27	Follow Safe Transport Procedures	35-2
Rear Roller Type	25-27	Transport Auger	35-3
Rear Number of Runs	25-28	Positioning Hitch Jack for Transport	
Reprogramming Monitor to Display Meter		Tow Between Cart	35-3
Shaft RPM	25-28	Tow Behind Cart	35-3
Monitor Seed Cart Activity	25-29	Raising and Lowering Parking	
Displaying and Clearing Accumulated		Stands—730 Air Disk Drill	35-4
Area and Sub-Area	25-30	Opening and Closing Transport Lock-Up	
Understanding Air Flow Readings	25-31	Valve—730 Air Disk Drill	35-4
Understanding Alarms and Error Codes	25-32		
Receiving Simultaneous Alarms and Recalling Past Alarms	25-33	Operating the Machine	
Error Codes		Checking Metering	
Communication	25-34	Stationary Test	40-2
Sensor Failure	25-34	Field Test	40-6
Monitor	25-35	Tank Capacity By Weight—100% Full	40-7
Remote Module	25-35	Filling Seed Tanks	40-7
Digital Display Codes	25-36	Emptying Seed Tanks	40-9
Confirming Bin Depth Value		Setting Fold/Marker Selector Valve—730 Air Disk Drill (If Equipped)	40-12
		Operating Guidelines	40-13
		Setting Selector Valve	40-14
		Preparing to Operate Machine In Field	40-14

Continued on next page

Contents

Page	Page		
Determining Fan Speed	40-15	Repair Auger Motor	55-32
Setting Fan Speed	40-16	Hydraulic Schematic	
Operating Seeder Switches	40-17	Seed Cart	55-34
Remote Seeder Switch	40-18	Auger Hydraulics	55-35
Operating In the Field	40-18	Clean Fan	55-36
 Lubrication and Maintenance	 45-1	 Storage	 60-1
 Troubleshooting	 50-1	 Specifications	
 Service		Machine Specifications	
Using Safe Service Procedures	55-1	230 Bushel	65-1
Stay Clear of Air Hoses	55-1	170 Bushel	65-2
Keep Shields In Place	55-1	Repair	65-3
Keep Service Area Clean	55-2	Tractor	65-4
Tightening Hardware	55-2	Serial Number	65-4
Unified Inch Bolt and Cap Screw Torque		 Crime Prevention Tips	 70-1
Values	55-3	 Index	
Metric Bolt and Cap Screw Torque			
Values	55-4		
Checking Wheel Attaching Hardware and			
Bearings	55-5		
Service Tires Safely	55-5		
Common Circuit Test	55-6		
Monitor and Switch Unit			
Wiring Diagram	55-7		
Diagnose Monitor System Power			
Problems	55-8		
Wire Color Code	55-11		
Wiring Harnesses			
Tractor	55-12		
Seeding Tool Extension (Tow-Behind			
Only)	55-13		
Hitch (Early Version)	55-14		
Hitch (Later Version)	55-15		
Seeder Frame	55-16		
Testing			
Fan RPM Sensor	55-17		
Ground Speed/Area Sensor	55-18		
Meter Shaft RPM Sensors	55-19		
Air Flow Sensors	55-20		
Bin Level Sensors	55-21		
Main Electric Clutch	55-22		
Interdrive Solenoids	55-23		
Testing Remote Seeder Switch	55-24		
Prevent Hydraulic System Contamination	55-25		
Repair Fan/Auger Selector Valve	55-26		
Disassemble, Inspect and Repair			
Fan Motor	55-28		
Auger Control Valve	55-30		

Safety

RECOGNIZE SAFETY INFORMATION

This is the safety-alert symbol. When you see this symbol on your machine or in this manual, be alert to the potential for personal injury.

Follow recommended precautions and safe operating practices.



DX,ALERT -19-03MAR93

T81389 -UN-07DEC88

UNDERSTAND SIGNAL WORDS

A signal word—DANGER, WARNING, or CAUTION—is used with the safety-alert symbol. DANGER identifies the most serious hazards.

DANGER or WARNING safety signs are located near specific hazards. General precautions are listed on CAUTION safety signs. CAUTION also calls attention to safety messages in this manual.



DX,SIGNAL -19-03MAR93

TS187 -19-30SEP88

FOLLOW SAFETY INSTRUCTIONS

Carefully read all safety messages in this manual and on your machine safety signs. Keep safety signs in good condition. Replace missing or damaged safety signs. Be sure new equipment components and repair parts include the current safety signs. Replacement safety signs are available from your John Deere dealer.

Learn how to operate the machine and how to use controls properly. Do not let anyone operate without instruction.

Keep your machine in proper working condition. Unauthorized modifications to the machine may impair the function and/or safety and affect machine life.

If you do not understand any part of this manual and need assistance, contact your John Deere dealer.

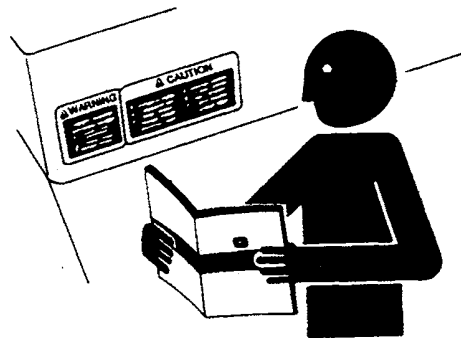

DX,READ -19-03MAR93

TS201 -UN-29AUG88



OPERATE SAFELY

Clear area around machine before raising or lowering machine or wings.

Stop tractor on level ground when raising or lowering wings.

DO NOT enter tank unless another person is present and hydraulic hoses are disconnected from tractor.

Operate machine from the tractor seat only.

Lock auger in transport position before operating in the field.

Do not operate with wings raised.

Do not operate close to a ditch or creek.

Slow down when turning or traveling over rough ground.

Shut off tractor and shift to "Park" or set brakes when leaving tractor. Remove key when leaving tractor unattended.

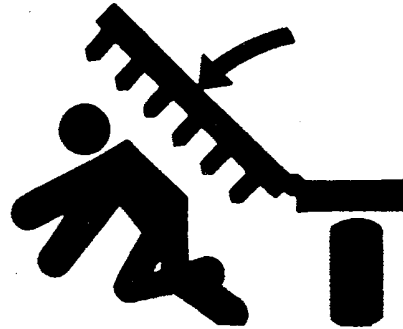

N39547 -UN-06OCT88

1N4,777C,A28 -19-18DEC91

STAY CLEAR OF AIR HOSES

Stay clear of hoses when air seeder fan is running. Seed or fertilizer blowing out at high speed can cause blindness and other personal injuries.

Never attempt to clear blockage from air hoses or seeding tool boots while fan is running.

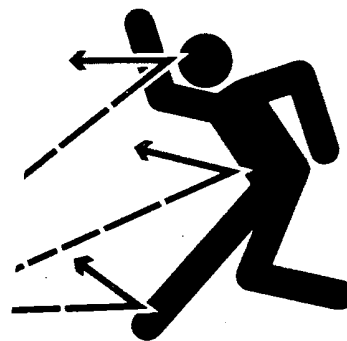

TS265 -UN-23AUG88

1N4,610STC,A18 -19-14OCT88



USE A SIGNAL PERSON

Use a signal person to direct movement of the tractor/seed cart/seeding tool combination, whenever the tractor operator's view is obstructed.

Designate one individual as THE signal person. Always have signal person stand in clear view. Be sure signal person stays a safe distance away from the machine when it is moving.

Prior to starting the tractor, discuss hand signals and what each signal means to avoid misunderstandings and confusion which could result in a serious injury or fatal accident for someone.

Keep all bystanders away whenever the machine is moved.

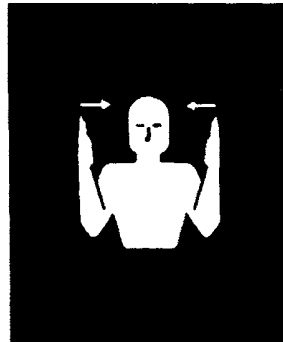

N43984 -JUN-11DEC91

NX,787C,A2 -19-18DEC91

KEEP SHIELDS IN PLACE

Do not operate air seeder without safety shields in place.

Rotating parts can crush or dismember causing death or personal injury.

Shut off tractor and disconnect hydraulic hose before remove shields for adjustment or service.



TS268 -JUN-23AUG88

1N4,777C,A32 -19-01FEB89



PARK SAFELY

Park machine on a level surface and block wheels.

Secure hitch jack(s) with pin(s).

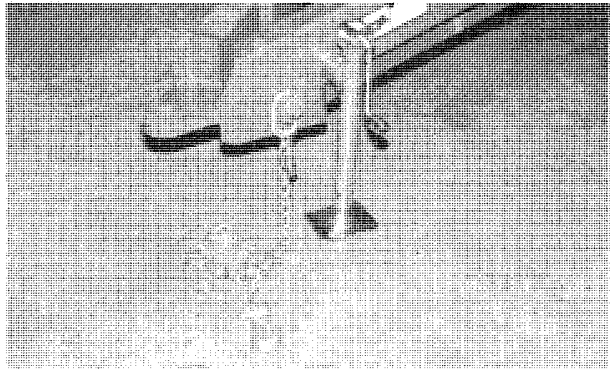

Tow Between

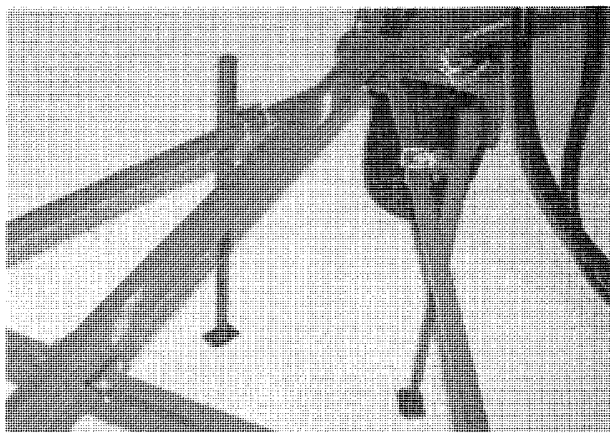

Tow Behind

-JUN-28OCT81

N43909

-JUN-26NOV90

N40768

NX,787C,A1 -19-25OCT91

WEAR PROTECTIVE CLOTHING

Wear close fitting clothing and safety equipment appropriate to the job.

Operating equipment safely requires the full attention of the operator. Do not wear radio or music headphones while operating machine.

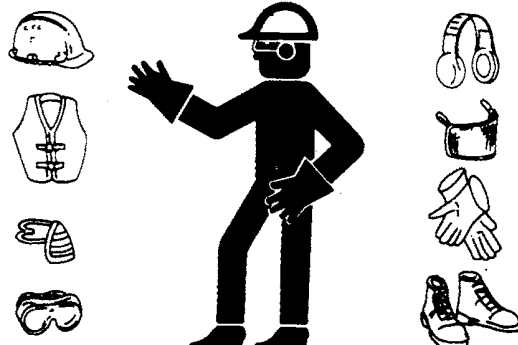

DX,WEAR2 -19-03MAR93

-JUN-23AUG88

TS206



HANDLE PESTICIDES AND FERTILIZERS CAREFULLY

Keep dust away from skin and hair.

Keep containers low when pouring.

Let the wind blow fumes away from you when mixing with seed or when filling tank.

Wear a filtered respirator if you cannot avoid dust.

Wear goggles to protect your eyes.

Wash exposed skin areas frequently—do not leave pesticide on your skin.

Do not smoke while handling pesticides.

Properly dispose of pesticide container, unused pesticide and left-over treated seed and fertilizer.

Read and observe manufacturers recommendations.

Store pesticides in a separate, plainly marked LOCKED building.

Store pesticides in original containers with labels intact.

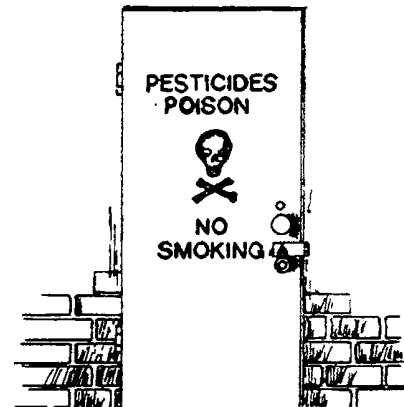

N35988 -JUN-04/OCT88

N35988

N35988 -JUN-04/OCT88

N35988

N33983 -19-31/JAN89

N33983

N04,655C,A -19-05APR84



KEEP RIDERS OFF MACHINE

Keep riders off.

Riders are subject to injury such as being struck by foreign objects and being thrown off the machine. Riders also obstruct the operator's view resulting in the machine being operated in an unsafe manner.



1N4,610C,A2 -19-21JUN88

N40002 -JUN-26SEP88

USE SAFETY LIGHTS AND DEVICES

Slow moving tractors, self-propelled equipment and towed implements or attachments can create a hazard when driven on public roads. They are difficult to see, especially at night. Avoid personal injury or death resulting from collision with a vehicle.

Whenever driving on public roads, use flashing warning lights and turn signal according to local regulation. To increase visibility, use the lights and devices provided with your machine. For some equipment, install extra flashing warning lights.

Keep safety items in good condition. Replace missing or damaged items. An implement safety lighting kit is available from your John Deere dealer.

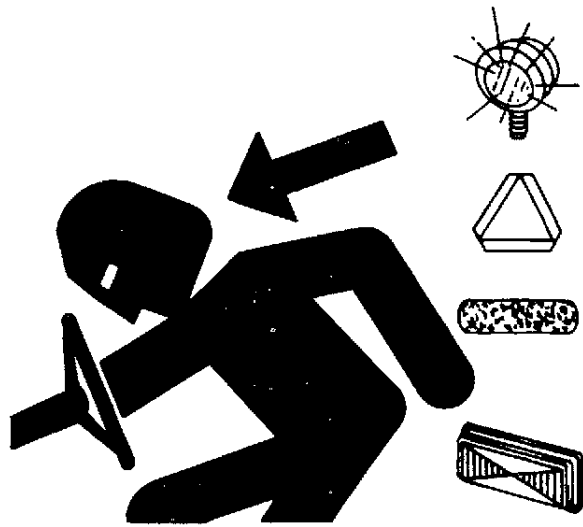

DX,FLASH -19-15MAR93

TSS91 -JUN-12APR90

USE A SAFETY CHAIN

A safety chain will help control drawn equipment should it accidentally separate from the drawbar.

Using the appropriate adapter parts, attach the chain to the tractor drawbar support or other specified anchor location. Provide only enough slack in the chain to permit turning.

See your John Deere dealer for a chain with a strength rating equal to or greater than the gross weight of the towed machine. Do not use safety chain for towing.

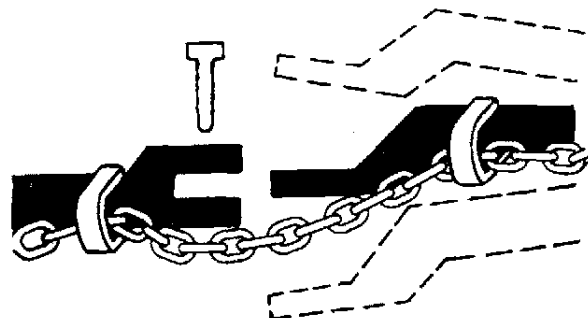

DX,CHAIN -19-03MAR93

TS217 -JUN-29AUG88



TRANSPORT SAFELY

Keep away from overhead power lines. Serious injury or death may result. Know the transport height of your machine.

Always fold wings fully. If wing fold cylinders are removed, chain wings together to prevent accidental lowering.

Install transport lockups on depth control cylinders.

ALWAYS travel at a reasonable and safe speed.

Use transport hitch when traveling without seeding tool (tow behind models).

DO NOT use transport hitch with material in tank.

NEVER transport with air seeder fan running.

ALWAYS lock auger in transport position.

NEVER transport with meter shafts engaged.

Shift the tractor into a lower gear when transporting down steep slopes or hills.

Latch the tractor brakes together.

Stop slowly.

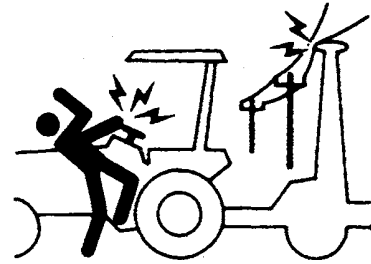

1N4,777C,A30A -19-09SEP91

N59394 -JUN-06OCT88

SERVICE MACHINE SAFELY

To help prevent personal injury caused by unexpected movement, be sure to service machine on level surface.

If machine is connected to tractor, engage parking brake and/or place transmission in "PARK", shut off engine and remove key.

If machine is detached from tractor, block wheels and use safety stands to prevent movement.

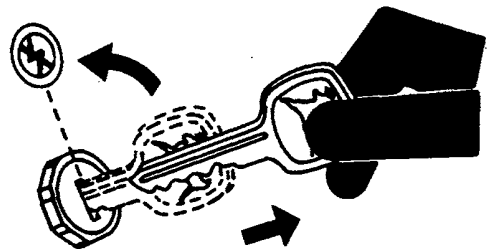

1N4,777C,A31 -19-11FEB86

TS230 -JUN-24MAY89



PRACTICE SAFE MAINTENANCE

Understand service procedure before doing work. Keep area clean and dry.

Never lubricate, service, or adjust machine while it is moving. Keep hands, feet, and clothing from power-driven parts. Disengage all power and operate controls to relieve pressure. Lower equipment to the ground. Stop the engine. Remove the key. Allow machine to cool.

Securely support any machine elements that must be raised for service work.

Keep all parts in good condition and properly installed. Fix damage immediately. Replace worn or broken parts. Remove any buildup of grease, oil, or debris.

Disconnect battery ground cable (-) before making adjustments on electrical systems or welding on machine.



-JUN-23AUG88

TS218

DX,SERV -19-03MAR93

AVOID HIGH-PRESSURE FLUIDS

Escaping fluid under pressure can penetrate the skin causing serious injury.

Avoid the hazard by relieving pressure before disconnecting hydraulic or other lines. Tighten all connections before applying pressure.

Search for leaks with a piece of cardboard. Protect hands and body from high pressure fluids.

If an accident occurs, see a doctor immediately. Any fluid injected into the skin must be surgically removed within a few hours or gangrene may result. Doctors unfamiliar with this type of injury should reference a knowledgeable medical source. Such information is available from Deere & Company Medical Department in Moline, Illinois, U.S.A.

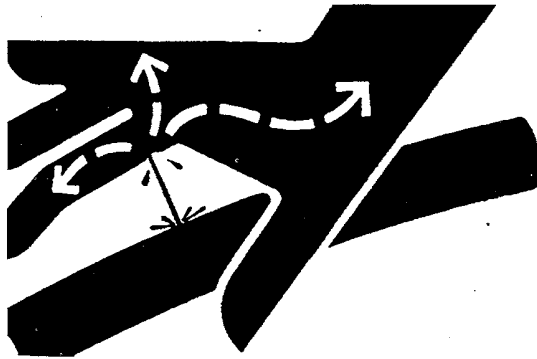

-JUN-23AUG88

X9811

DX,FLUID -19-03MAR93



SERVICE TIRES SAFELY

Explosive separation of a tire and rim parts can cause serious injury or death.

Do not attempt to mount a tire unless you have the proper equipment and experience to perform the job.

Always maintain the correct tire pressure. Do not inflate the tires above the recommended pressure. Never weld or heat a wheel and tire assembly. The heat can cause an increase in air pressure resulting in a tire explosion. Welding can structurally weaken or deform the wheel.

When inflating tires, use a clip-on chuck and extension hose long enough to allow you to stand to one side and NOT in front of or over the tire assembly. Use a safety cage if available.

Check wheels for low pressure, cuts, bubbles, damaged rims or missing lug bolts and nuts.

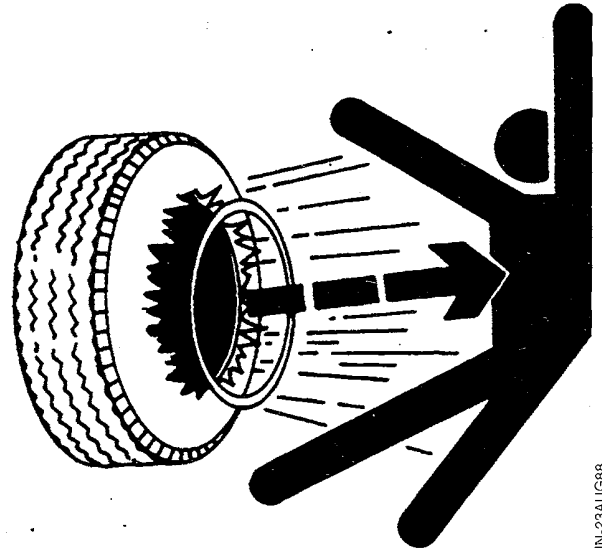

DX,RIM -19-24AUG90

TSS211 -JUN-23AUG88

Safety Signs

CAUTION

1. Keep all shields in place.
2. Disengage and shut off all engine and/or motor power before servicing or unclogging machine.
3. Keep hands, feet and clothing away from power driven parts.

WARNING



Stop Fan Before Opening Lid.
Avoid Exposure To Airborne Chemicals.
Dust And Fumes Will Be Exhausted If Tank Lid Is Opened While Tank Is Pressurized.

DANGER



1. Stop engine and remove key before removing fan shield.
2. Do not operate fan with shield removed.

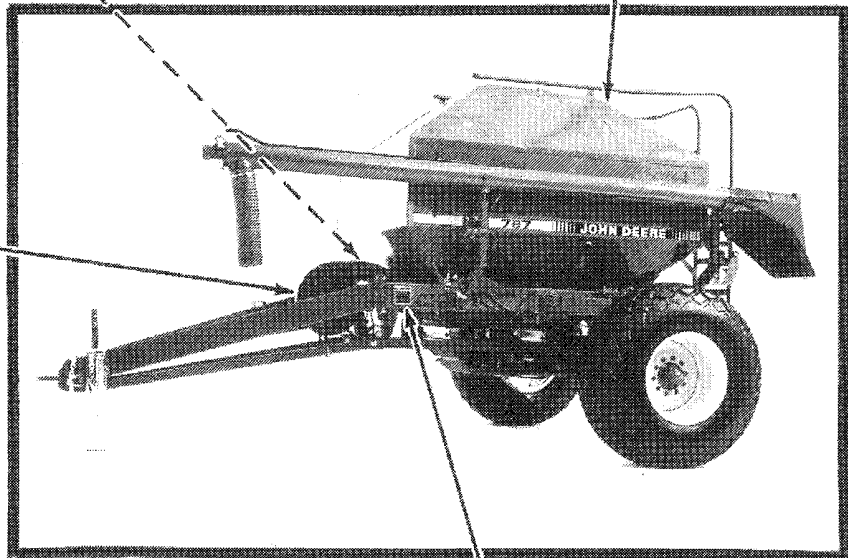

CAUTION

1. Before operating machine, read operator's manual for complete instructions and safety information.
2. Make certain everyone is clear of machine and equipment before starting operation.
3. Keep all riders off machine and equipment.
4. Wait for all movement to stop before servicing or adjusting machine or equipment.

N43922A -19-13JUN94

▲ WARNING

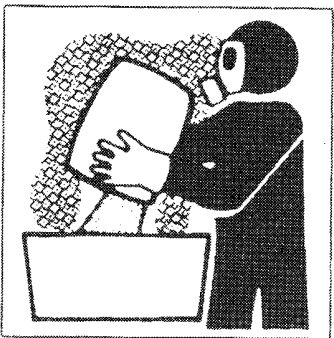

Chemicals may cause eye, skin, or breathing problems. Wear face mask, gloves, and goggles. Read and follow safety instructions on the chemical supplier's label.

▲ WARNING

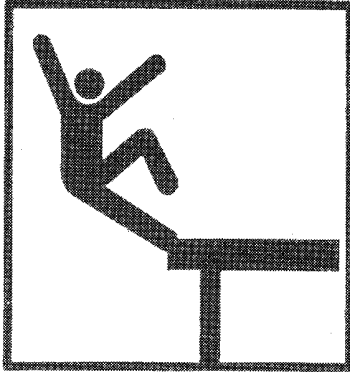

1. Do not ride on machine.
2. Do not stand on tank.

▲ CAUTION

1. Keep all shields in place.
2. Disengage and shut off all engine and/or motor power before servicing or unclogging machine.
3. Keep hands, feet and clothing away from power driven parts.

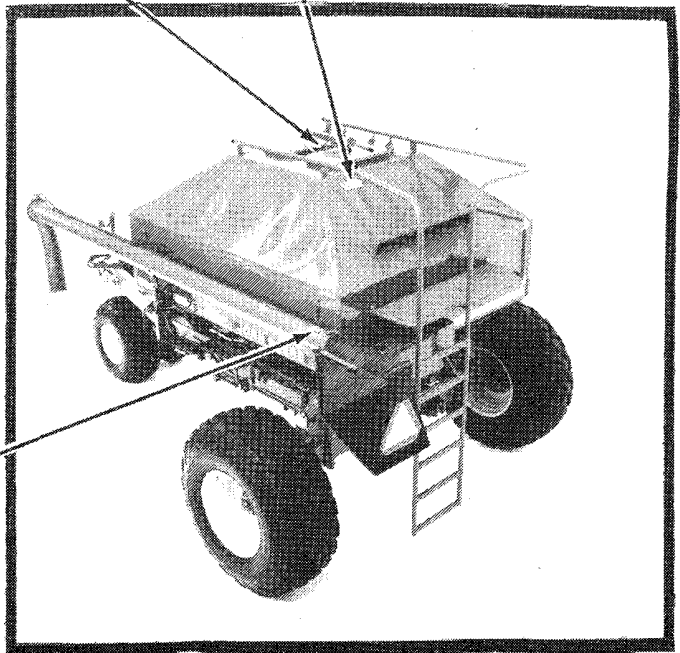

Preparing the Tractor

DETERMINING TRACTOR REQUIREMENTS

1. See Recommended Tractors in Specifications section.
2. Install adapters, if tractor does not have ISO hydraulic couplers. See your John Deere dealer.

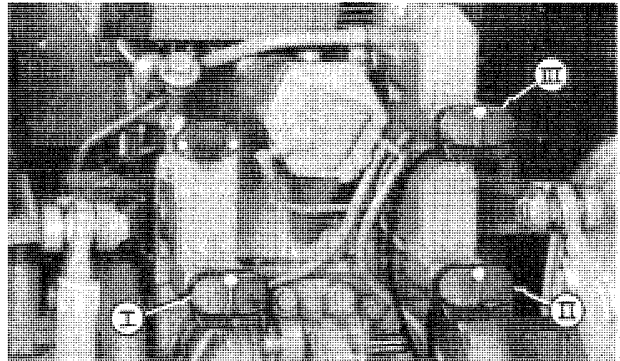

55—60 Series Tractors

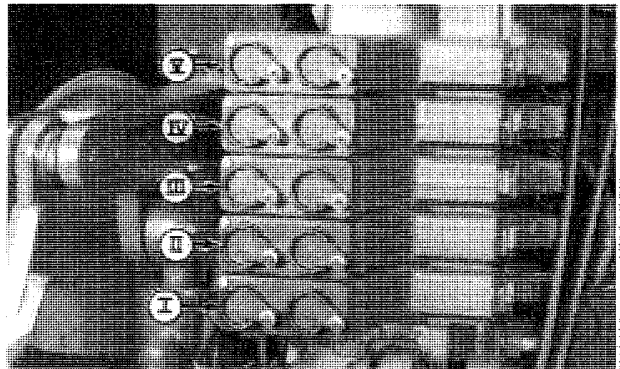

8000 Series Tractors

NXB,630V,C -19-20JUN94

CAUTION: Make sure tractor master shield (A) and driveline guard (B) are in place at all times, to prevent entanglement with rotating PTO shaft. Coming in contact with a rotating PTO shaft can severely injure or kill you.

3. Consult tractor operator's manual for specific adjustment procedures, tire inflation, wheel spacing, and ballast requirements.

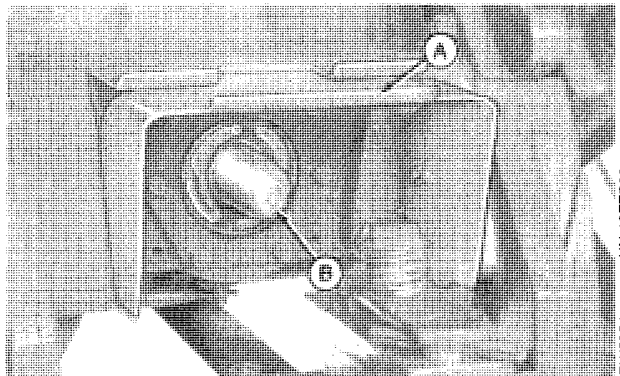

NX,1060SO,V2,A1-19-23SEP93

TRACTOR HYDRAULIC SYSTEM REQUIREMENTS

Operation of the hydraulically driven fan requires tractor to have either a load sensing hydraulic system or a closed center hydraulic system with flow control. These types of hydraulic systems usually have large oil reservoirs and increased oil cooling capacity and deliver only the oil flow needed for the fan motor to consistently maintain fan speed at the selected RPMs without surging.

Tractors with open center hydraulic systems are not recommended for the following reasons:

- No means to control volume of oil flow.
- Excessive oil temperature.
- Decreased oil flow to fan motor during operation of other tractor control valves.
- Reduced oil flow to tractor power steering.

Required oil flow (Gallons Per Minute) can be determined by multiplying 0.0029 x suggested fan RPM. Hydraulic oil pressure will range between 1500—2000 psi for most normal applications. Hydraulic oil pressure to 2250 psi may be required for heavy product flow rates.

EXAMPLE:

$$0.0029 \times 3500 \text{ rpm} = 10.15 \text{ GPM}$$

IMPORTANT: In addition to the above requirements, tractor **MUST** also be equipped with a low pressure drain line connection, for the fan motor case drain.

See your John Deere dealer for installation of a Low Pressure Drain Line Kit, if your tractor is not so equipped.

Make sure tractor hydraulic system meets all requirements.

SECURING 3-POINT HITCH

If equipped with quick-coupler, raise 3-point hitch fully.

If not equipped with quick-coupler, secure lift links (A) and center link (B) so they do not swing into tractor tires or onto hoses.

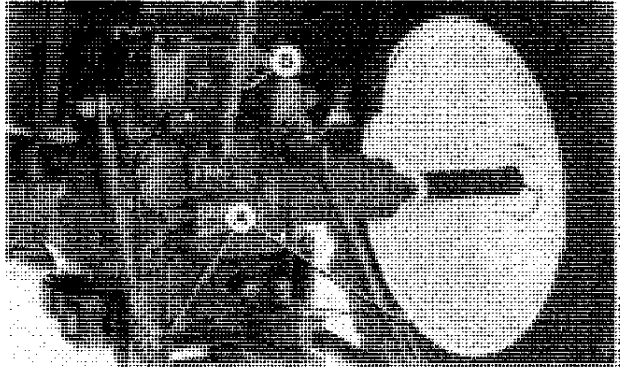

N03,940V,D -19-30OCT92

ADJUSTING METERING VALVES

Metering valve (A) is used to determine speed of hydraulic fan.

Refer to Setting Fan Speed in Operating the Machine section.

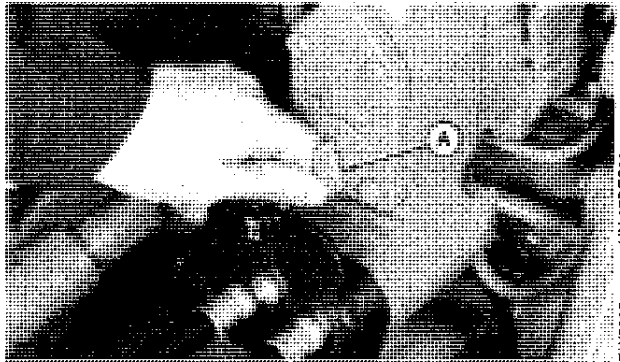

55-60 Series Tractors

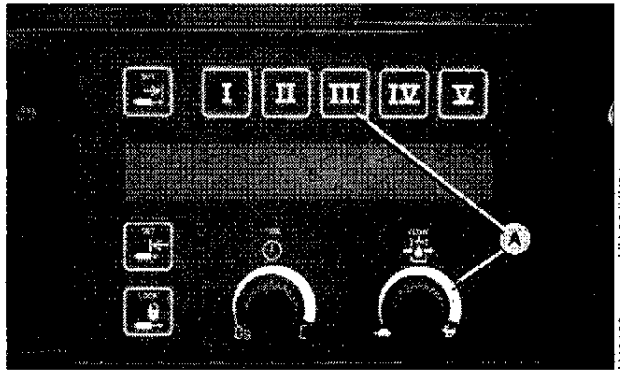

8000 Series Tractors

1N4,777V,A23A -19-16AUG94

INSTALL LEVER LOCK CLIP (55-60 SERIES TRACTORS)

Install forward lever lock clip on No. 3 tractor control lever.

NOTE: Installation instructions are in lever lock bundle.
See Setting Fan Speed in Operating the Machine section for field operation.

1N4,777V,A24A -19-11AUG94

POSITIONING DRAWBAR

⚠ CAUTION: Avoid personal injury or death due to losing steering control of machine. Always pin drawbar in center position for ALL tractors, when transporting machine.

1. Place drawbar in fixed centered position, as close as possible to 457 mm (18 in.) from ground to top of drawbar. For tow-between cart use shortest drawbar possible or pin drawbar in innermost position.

2. Be sure clevis assembly (if equipped) is installed on top of drawbar.

3. Torque clevis assembly bolts to 407 N·m (300 lb-ft).

NOTE: For four-wheel drive tractors, leave one hole clearance on each side of drawbar for field operation only.

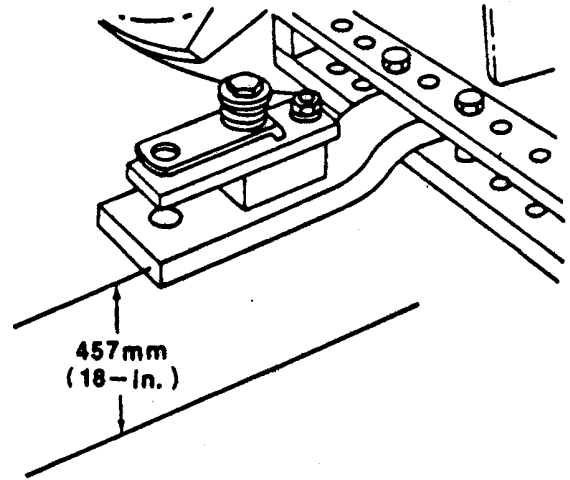

Thank you so much for reading.
Please click the “Buy Now!”
button below to download the
complete manual.



After you pay.

You can download the most
perfect and complete manual in
the world immediately.

Our support email:

ebooklibonline@outlook.com