

**676
Rotary
Harvesting Unit**

**John Deere Werke Zweibrücken
OMZ92376 Issue C7**

**North American Edition
LITHO IN U.S.A.
ENGLISCH**

Introduction

READ THIS MANUAL carefully to learn how to operate and service your machine correctly. Failure to do so could result in personal injury or equipment damage. This manual and safety signs on your machine may also be available in other languages. (See your John Deere dealer to order.)

THIS MANUAL SHOULD BE CONSIDERED a permanent part of your machine and should remain with the machine when you sell it.

MEASUREMENTS in this manual are given in both metric and customary U.S. unit equivalents. Use only correct replacement parts and fasteners. Metric and inch fasteners may require a specific metric or inch wrench.

RIGHT-HAND AND LEFT-HAND sides are determined by facing in the direction the implement will travel when going forward.

WRITE PRODUCT IDENTIFICATION NUMBERS (P.I.N.) in the Specification section. Accurately record

all the numbers to help in tracing the machine should it be stolen. Your dealer also needs these numbers when you order parts. File the identification numbers in a secure place off the machine.

WARRANTY is provided as part of John Deere's support program for customers who operate and maintain their equipment as described in this manual. The warranty is explained on the warranty certificate which you should have received from your dealer.

This warranty provides you the assurance that John Deere will back its products where defects appear within the warranty period. In some circumstances, John Deere also provides field improvements, often without charge to the customer, even if the product is out of warranty. Should the equipment be abused, or modified to change its performance beyond the original factory specifications, the warranty will become void and field improvements may be denied. Setting fuel delivery above specifications or otherwise overpowering machines will result in such action.

Contents

	Page		Page
Identification View	00-1	Down-crop auger drive	50-8
Safety	05-1	Storage	55-1
Safety Decals	10-1	Specifications	60-1
Preparing the Forage Harvester	15-1	Serial Number	65-1
Attaching and Detaching	20-1	Crime Prevention	70-1
Locking the harvesting unit	20-1	Index	
Hydraulic connections for tilting	20-2		
Electrical connection for blade rotor brake	20-2		
Transport	25-1		
Folding the harvesting unit	25-2		
Operating the Rotary Harvesting Unit	30-1		
Method of operation	30-2		
Adjusting the feed bar	30-2		
Skid plates	30-3		
Blade rotor brake	30-4		
Operating the harvesting unit	30-5		
Harvesting down-crop	30-6		
Harvesting short-stemmed corn	30-6		
Troubleshooting	40-1		
Lubrication and Periodic Service	45-1		
Grease	45-1		
Gear oil	45-2		
Oil level in transmissions	45-3		
Lubrication	45-4		
Periodic service	45-6		
Service	50-1		
Main drive	50-2		
Gatherer and feed drums	50-3		
Intake and cutting area	50-4		
Crop feed area	50-7		

All information, illustrations and specifications in this manual are based on the latest information available at the time of publication. The right is reserved to make changes at any time without notice.

OMZ92376 C7-19-14MAR97

COPYRIGHT© 1997
 DEERE & COMPANY
 European Office Mannheim
 All rights reserved
 A John Deere ILLUSTRATION® Manual
 Previous Editions
 Copyright1995 Deere & Company

Identification View

IDENTIFICATION VIEW



ZX007006 -JUN-21MAR95

ZX,676RHU003833-19-20JAN95

Safety

RECOGNIZE SAFETY INFORMATION

This is the safety-alert symbol. When you see this symbol on your machine or in this manual, be alert to the potential for personal injury.

Follow recommended precautions and safe operating practices.



DX,ALERT -19-03MAR93

T81389 -UN-07DEC68

FOLLOW SAFETY INSTRUCTIONS

Carefully read all safety messages in this manual and on your machine safety signs. Keep safety signs in good condition. Replace missing or damaged safety signs. Be sure new equipment components and repair parts include the current safety signs. Replacement safety signs are available from your John Deere dealer.

Learn how to operate the machine and how to use controls properly. Do not let anyone operate without instruction.

Keep your machine in proper working condition. Unauthorized modifications to the machine may impair the function and/or safety and affect machine life.

If you do not understand any part of this manual and need assistance, contact your John Deere dealer.

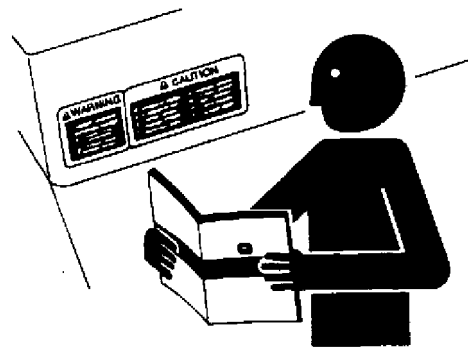

DX,READ -19-03MAR93

T5201 -UN-23AUG88

UNDERSTAND SIGNAL WORDS

A signal word—DANGER, WARNING, or CAUTION—is used with the safety-alert symbol. DANGER identifies the most serious hazards.

DANGER or WARNING safety signs are located near specific hazards. General precautions are listed on CAUTION safety signs. CAUTION also calls attention to safety messages in this manual.



▲ WARNING

▲ CAUTION

DX,SIGNAL -19-03MAR93

T5187 -19-30SEP88



OBSERVE ROAD TRAFFIC REGULATIONS

Always observe local road traffic regulations when using public roads.



FX,ROAD -19-01MAY91

H28930 -UN-30JUN89

USE SAFETY LIGHTS AND DEVICES

Prevent collisions between other road users, slow moving tractors with attachments or towed equipment, and self-propelled machines on public roads. Frequently check for traffic from the rear, especially in turns, and use hand signals or turn signal lights.

Use headlights, flashing warning lights, and turn signals day and night. Follow local regulations for equipment lighting and marking. Keep lighting and marking visible and in good working order. Replace or repair lighting and marking that has been damaged or lost. An implement safety lighting kit is available from your John Deere dealer.

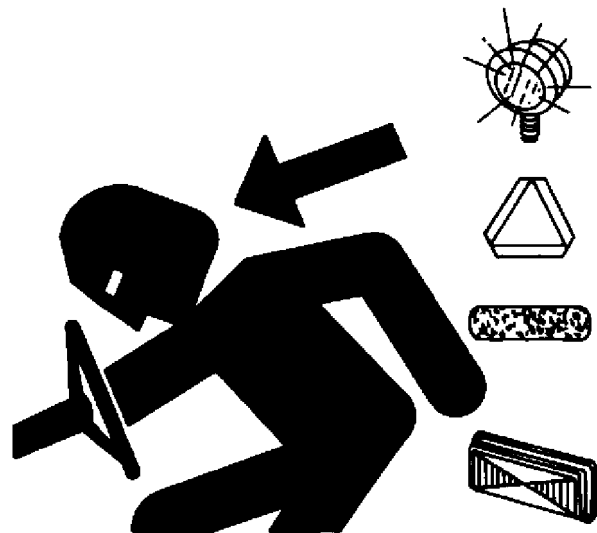

DX,FLASH -19-12SEP95

T5951 -UN-12APR90

PREPARE FOR EMERGENCIES

Be prepared if a fire starts.

Keep a first aid kit and fire extinguisher handy.

Keep emergency numbers for doctors, ambulance service, hospital, and fire department near your telephone.

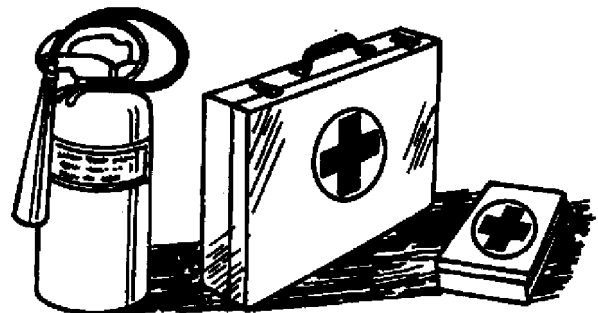

DX,FIRE2 -19-03MAR93

T5291 -UN-23AUG88



WEAR PROTECTIVE CLOTHING

Wear close fitting clothing and safety equipment appropriate to the job.

Prolonged exposure to loud noise can cause impairment or loss of hearing.

Wear a suitable hearing protective device such as earmuffs or earplugs to protect against objectionable or uncomfortable loud noises.

Operating equipment safely requires the full attention of the operator. Do not wear radio or music headphones while operating machine.

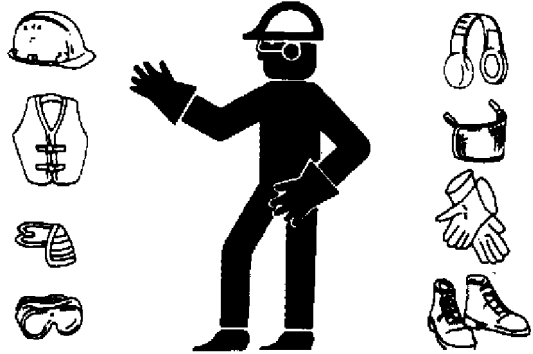

DX,WEAR -19-10SEP90

TS206 -UN-23AUG68

CHECK MACHINE SAFETY

Always check the road and general operating safety of the machine before using.

FX,READY -19-28FEB91

GUARDS AND SHIELDS

Keep guards and shields in place at all times. Ensure that they are serviceable and installed correctly.

Always disengage main clutch, shut off engine and remove key before removing any guards or shields.

Keep hands, feet and clothing away from moving parts.

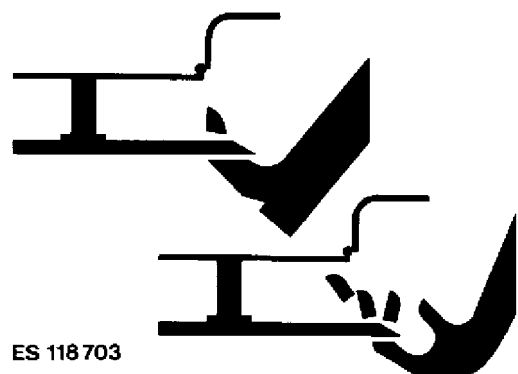

ES 118 703

FX,DEVICE -19-04DEC90

ES118703 -UN-21MAR95



STAY CLEAR OF HARVESTING UNITS

Due to their function, the cutting, gatherer and feed drums cannot all be completely shielded. Stay clear of these moving elements during operation. Always disengage main clutch, shut off engine and remove key before servicing or unclogging machine.



ZX,CUT676 -19-01NOV94

ES118704 -UN-21MAR95

KEEP HANDS AWAY FROM KNIVES

Never attempt to clear obstructions in front of or on harvesting unit unless main clutch is disengaged, engine shut off and key removed.

Everyone must be clear of the forage harvester before starting the engine.



-19-21DEC90

TS254 -UN-23AUG88

STORE ATTACHMENTS SAFELY

Stored attachments such as dual wheels, cage wheels, and loaders can fall and cause serious injury or death.

Securely store attachments and implements to prevent falling. Keep playing children and bystanders away from storage area.



-19-03MAR93

TS219 -UN-23AUG88



PRACTICE SAFE MAINTENANCE

Understand service procedure before doing work. Keep area clean and dry.

Never lubricate, service, or adjust machine while it is moving. Keep hands, feet, and clothing from power-driven parts. Disengage all power and operate controls to relieve pressure. Lower equipment to the ground. Stop the engine. Remove the key. Allow machine to cool.

Securely support any machine elements that must be raised for service work.

Keep all parts in good condition and properly installed. Fix damage immediately. Replace worn or broken parts. Remove any buildup of grease, oil, or debris.

Disconnect battery ground cable (-) before making adjustments on electrical systems or welding on machine.



DX,SERV -19-03MAR93

TS218 -UN-23AUG88

STAY CLEAR OF ROTATING DRIVELINES

Entanglement in rotating driveline can cause serious injury or death.

Keep tractor master shield and driveline shields in place at all times. Make sure rotating shields turn freely.

Wear close fitting clothing. Stop the engine and be sure PTO driveline is stopped before making adjustments, connections, or cleaning out PTO driven equipment.



DX,PTO -19-12SEP95

TS1644 -UN-22AUG95

SERVICE MACHINES SAFELY

Tie long hair behind your head. Do not wear a necktie, scarf, loose clothing, or necklace when you work near machine tools or moving parts. If these items were to get caught, severe injury could result.

Remove rings and other jewelry to prevent electrical shorts and entanglement in moving parts.

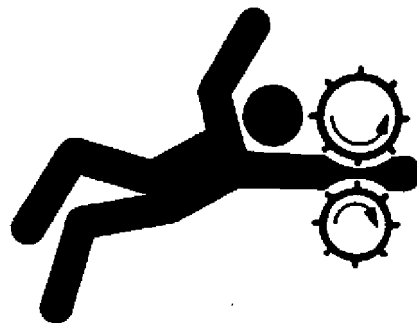

DX,LOOSE -19-04JUN90

TS5228 -UN-23AUG88



SUPPORT MACHINE PROPERLY

Always lower the attachment or implement to the ground before you work on the machine. If you must work on a lifted machine or attachment, securely support the machine or attachment.

Do not support the machine on cinder blocks, hollow tiles, or props that may crumble under continuous load. Do not work under a machine that is supported solely by a jack. Follow recommended procedures in this manual.

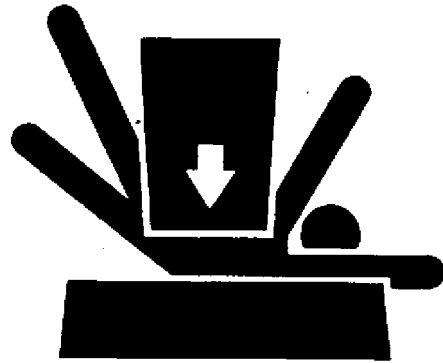

-UN-23AUG88
TS229

DX,LOWER -19-04JUN90

AVOID HIGH-PRESSURE FLUIDS

Escaping fluid under pressure can penetrate the skin causing serious injury.

Avoid the hazard by relieving pressure before disconnecting hydraulic or other lines. Tighten all connections before applying pressure.

Search for leaks with a piece of cardboard. Protect hands and body from high pressure fluids.

If an accident occurs, see a doctor immediately. Any fluid injected into the skin must be surgically removed within a few hours or gangrene may result. Doctors unfamiliar with this type of injury should reference a knowledgeable medical source. Such information is available from Deere & Company Medical Department in Moline, Illinois, U.S.A.

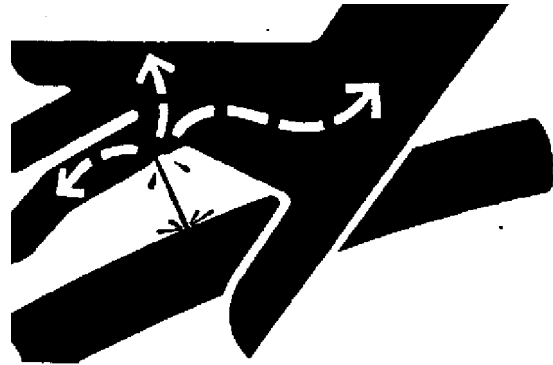

-UN-23AUG88
X9811

DX,FLUID -19-03MAR93



TRANSPORT WITH HARVESTING UNIT INSTALLED

Before driving forage harvester on public roads, harvesting unit must be raised and secured in the raised position. It must not, however, obstruct operator's view of the road.

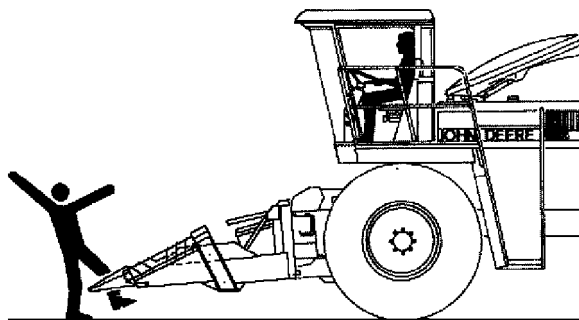

ZX007219

ZX HEADER676 -19-20JAN95

-UN-21MAR95
ZX007219

BALLASTING FOR SAFE GROUND CONTACT

Operating, steering and braking performance of forage harvester can be considerably affected by attachments which alter the center of gravity of the machine. To maintain safe ground contact, ballast the harvester at the rear end as necessary. Observe the maximum permissible axle loads and total weights.

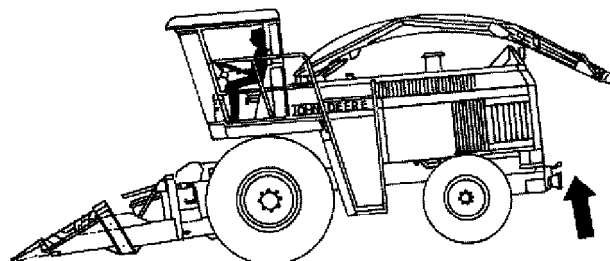

ZX007220

ZX WEIGHT676 -19-20JAN95

-UN-21MAR95
ZX007220

REMOVE PAINT BEFORE WELDING OR HEATING

Avoid potentially toxic fumes and dust.

Hazardous fumes can be generated when paint is heated by welding, soldering, or using a torch.

Do all work outside or in a well ventilated area. Dispose of paint and solvent properly.

Remove paint before welding or heating:

- If you sand or grind paint, avoid breathing the dust. Wear an approved respirator.
- If you use solvent or paint stripper, remove stripper with soap and water before welding. Remove solvent or paint stripper containers and other flammable material from area. Allow fumes to disperse at least 15 minutes before welding or heating.

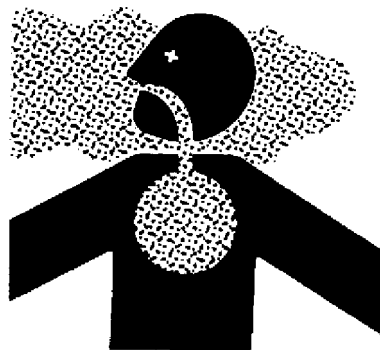

DX,PAINT -19-03MAR93

-UN-23AUG88
TS220

Thank you so much for reading.
Please click the “Buy Now!”
button below to download the
complete manual.



After you pay.

You can download the most
perfect and complete manual in
the world immediately.

Our support email:

ebooklibonline@outlook.com